



US00D806967S

(12) **United States Design Patent** (10) **Patent No.:** **US D806,967 S**
Lambert et al. (45) **Date of Patent:** **** Jan. 2, 2018**

(54) **PART OF A VACUUM CLEANER**
(71) Applicant: **Dyson Technology Limited**, Wiltshire (GB)
(72) Inventors: **Adam David Lambert**, Swindon (GB); **Paul Andrew McLuckie**, Bath (GB)
(73) Assignee: **Dyson Technology Limited**, Malmesbury, Wiltshire (GB)
(**) Term: **15 Years**
(21) Appl. No.: **29/576,502**
(22) Filed: **Sep. 2, 2016**
(30) **Foreign Application Priority Data**

Mar. 4, 2016 (EM) 003013697-0003

(51) **LOC (11) Cl.** **15-05**
(52) **U.S. Cl.**
USPC **D32/31**

(58) **Field of Classification Search**
USPC D8/396; D32/31-33, 35, 40, 50, 51
CPC F16M 13/02; A24F 19/092; F16L 27/12; A47L 9/242; A47L 9/02; A47L 9/06; A47L 9/0673; A47L 5/362; A47L 5/28; A47L 5/34; A47L 5/30; A47G 25/66; E04H 4/1654
See application file for complete search history.

(56) **References Cited**

U.S. PATENT DOCUMENTS

D217,285 S * 4/1970 Anderson D32/31
D267,906 S * 2/1983 Parise D32/31
D361,415 S * 8/1995 Knight D32/31
D470,983 S * 2/2003 Svaldi D32/31
D477,445 S * 7/2003 Schroter D32/31
D480,848 S * 10/2003 Smith D32/31
6,702,332 B2 * 3/2004 Young A47L 9/242
15/327.1
D502,578 S * 3/2005 Roschi D32/31

D532,947 S * 11/2006 Muscarella D32/31
D642,754 S * 8/2011 Fjellman D32/31
D647,266 S * 10/2011 Kim D32/31
D674,158 S * 1/2013 Kim D32/31
2010/0123305 A1 * 5/2010 Shih A47L 9/244
285/7

FOREIGN PATENT DOCUMENTS

EM 001799560-0001 1/2011
KR 30-0312968 11/2002
KR 30-0382327 5/2005
KR 30-0388928 8/2005
KR 30-0454661 7/2007

* cited by examiner

Primary Examiner — Ruth McInroy

(74) *Attorney, Agent, or Firm* — Morrison & Foerster LLP

(57) **CLAIM**

We claim the ornamental design for a part of a vacuum cleaner, as shown and described.

DESCRIPTION

The file of this patent contains at least one drawing executed in color. Copies of this patent with color drawings will be provided by the Office upon request and payment of the necessary fee.

FIG. 1 is a perspective view of a part of a vacuum cleaner showing our new design;

FIG. 2 is a side view thereof;

FIG. 3 is a side view of the opposite side of FIG. 2;

FIG. 4 is a top view thereof;

FIG. 5 is a bottom view thereof;

FIG. 6 is a front view thereof; and,

FIG. 7 is a rear view thereof.

The broken lines shown in the drawings illustrate portions of part of a vacuum cleaner that form no part of the claimed design.

1 Claim, 7 Drawing Sheets
(6 of 7 Drawing Sheet(s) Filed in Color)

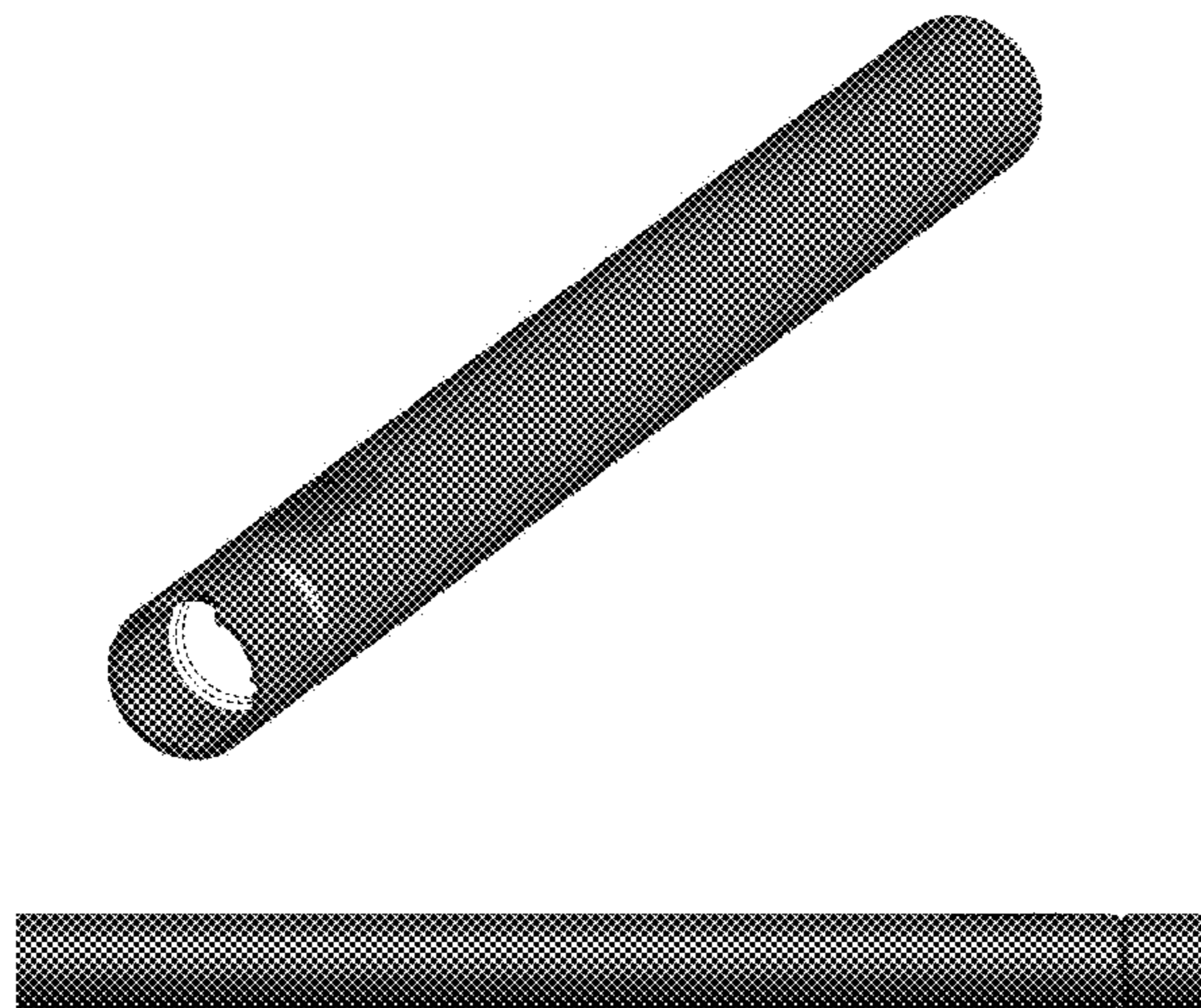



FIG. 1

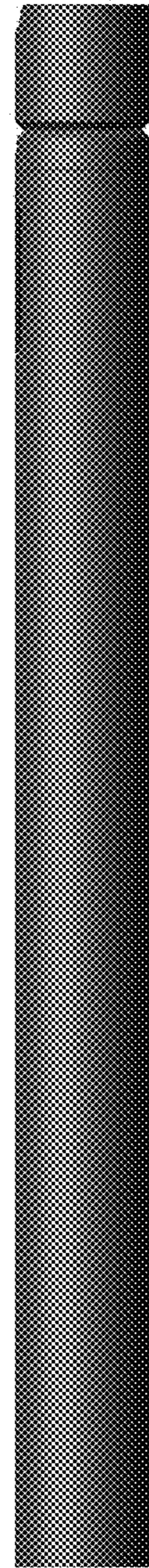

FIG. 2

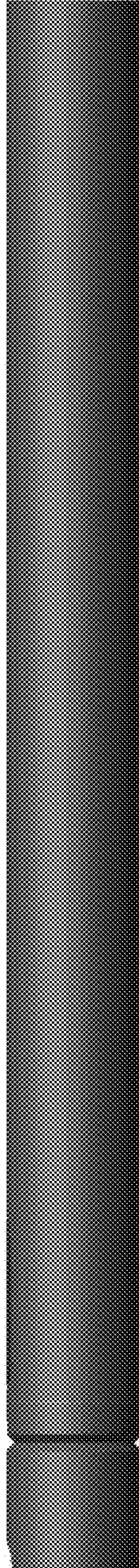

FIG. 3

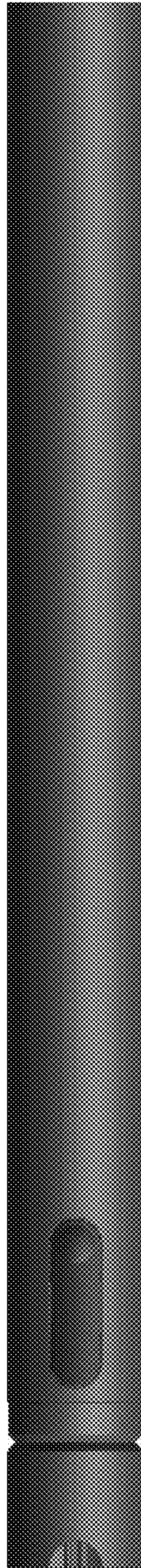

FIG. 4

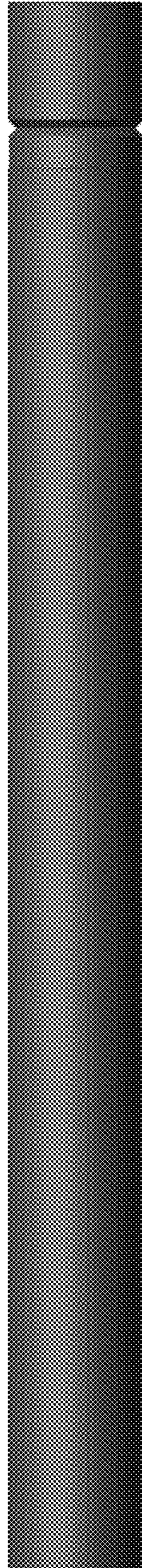

FIG. 5

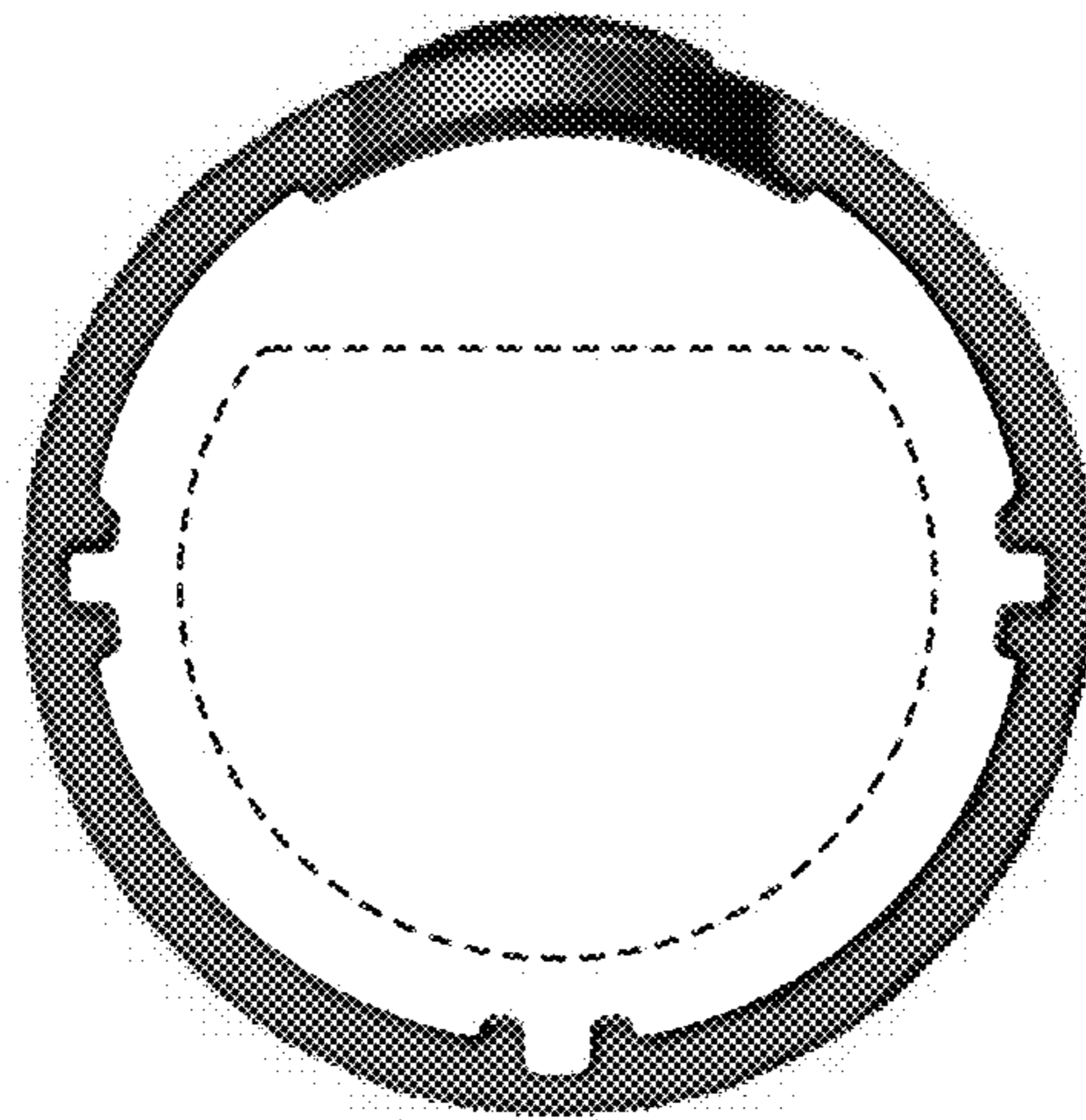

FIG. 6

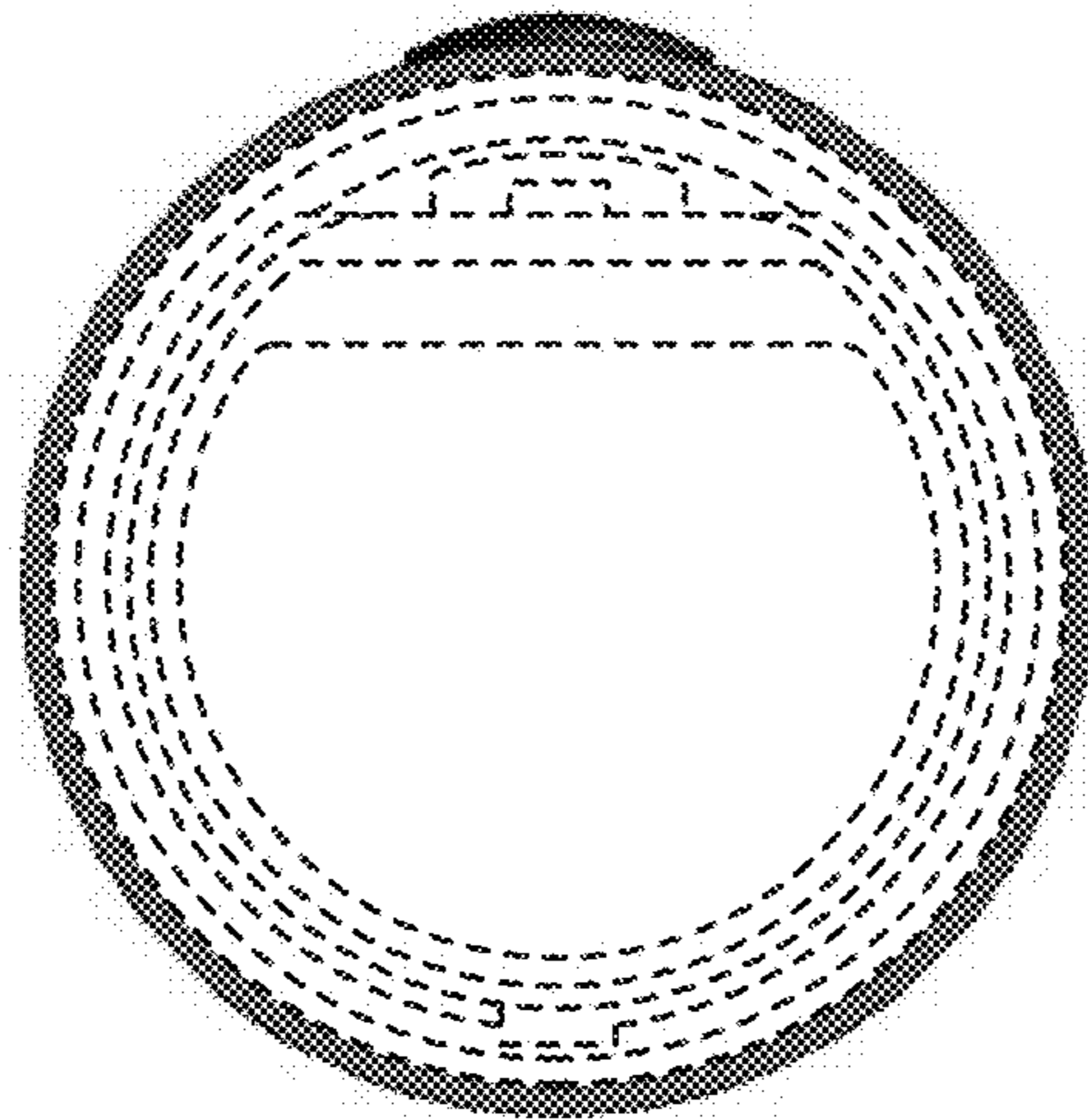

FIG. 7