



US00D806869S

(12) **United States Design Patent** (10) **Patent No.:** **US D806,869 S**
Menner et al. (45) **Date of Patent:** **** Jan. 2, 2018**

(54) **ABSORBENT ARTICLE WITH A PATTERN**

D479,989 S 9/2003 Drumm
D559,978 S * 1/2008 Bader D24/125
D583,936 S 12/2008 Sasayama
D631,540 S 1/2011 Venable
8,038,662 B2 10/2011 Hornung
8,449,517 B2 5/2013 Ueda

(71) Applicant: **The Procter & Gamble Company,**
Cincinnati, OH (US)

(72) Inventors: **Jeremy Menner,** Cincinnati, OH (US);
Vanessa Marie Melendez, Cincinnati,
OH (US); **Jessica Owen Stephens,**
Cincinnati, OH (US); **McKenzie Kae**
Elston, Cincinnati, OH (US)

(73) Assignee: **The Procter & Gamble Company,**
Cincinnati, OH (US)

(**) Term: **15 Years**

(21) Appl. No.: **29/593,488**

(22) Filed: **Feb. 9, 2017**

Related U.S. Application Data

(62) Division of application No. 29/534,764, filed on Jul.
31, 2015.

(51) **LOC (11) Cl.** **24-04**

(52) **U.S. Cl.**
USPC **D24/126**

(58) **Field of Classification Search**

USPC D2/700, 701; D24/124-126; 604/347,
604/348, 354, 358-361, 378, 385.01,
604/385.22, 385.24; D5/21, 25, 29, 35,
D5/37, 39, 53, 59, 60, 61
CPC A61F 13/15; A61F 13/64; A61F 13/476;
A61F 13/5611; A61F 13/5633; A61F
13/4704; A61F 13/535; A61F 13/539;
A61F 13/47; A61F 13/531

See application file for complete search history.

(56) **References Cited**

U.S. PATENT DOCUMENTS

D432,236 S 10/2000 Dutcher
D442,279 S 5/2001 Ruman et al.

FOREIGN PATENT DOCUMENTS

WO WO 2003-105741 A1 12/2003

OTHER PUBLICATIONS

Target.com cached archive copy from Jul. 23, 2014, accessed via
WaybackMachine.org on Dec. 10, 2015, with image of "Marie Meili
Curvy Women's Sofia Light Control Brief".

(Continued)

Primary Examiner — Ian Simmons

Assistant Examiner — Samantha Q Lawrence

(74) *Attorney, Agent, or Firm* — Dara M. Kendall

(57) **CLAIM**

The ornamental design for an absorbent article with a
pattern, as shown and described.

DESCRIPTION

FIG. 1 is a perspective view of an absorbent article with a
pattern,

FIG. 2 is a front view thereof;

FIG. 3 is a rear view thereof;

FIG. 4 is a right side view thereof;

FIG. 5 is a left side view thereof;

FIG. 6 is a top end view thereof; and,

FIG. 7 is a bottom end view thereof.

The stippling shown in the figures indicates a contrast in
appearance.

The broken lines shown in FIGS. 1-2 and 6-7 illustrate
portions of the absorbent article with a pattern that form no
part of the claimed design.

1 Claim, 5 Drawing Sheets

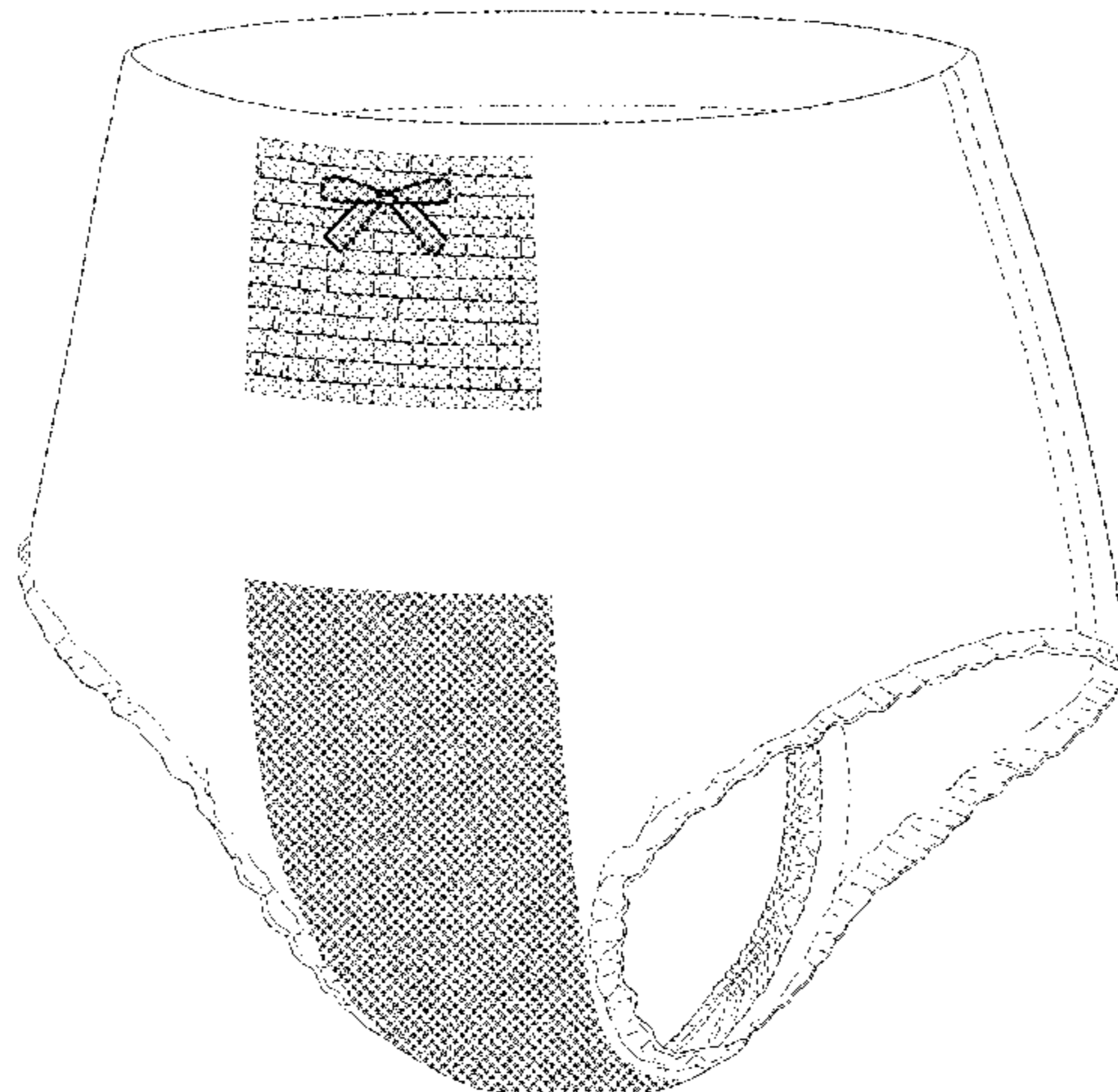

(56)

References Cited

U.S. PATENT DOCUMENTS

D693,464 S 11/2013 Neely
D733,872 S 7/2015 Beck
9,101,513 B2 8/2015 Takhashi
9,248,054 B2 2/2016 Brown
9,278,032 B2 3/2016 Morimoto
D782,157 S * 3/2017 Shoemaker A41B 9/008
D2/712
D782,663 S * 3/2017 Morimoto D24/126
9,610,203 B2 * 4/2017 Wade A61F 13/49014
9,622,922 B2 * 4/2017 Nelson A61F 13/51478
2001/0053898 A1 12/2001 Olson et al.
2006/0173436 A1 8/2006 Krautkramer et al.
2010/0076394 A1 3/2010 Hayase et al.
2013/0306225 A1 11/2013 Wade et al.
2013/0324956 A1 12/2013 Zink et al.

OTHER PUBLICATIONS

Target.com cached archive copy from Jul. 23, 2014, accessed via WaybackMachine.org on Dec. 10, 2015, with image of "Women's Cotton with Lace Hipster Panty-Xhilaration".

Target.com cached archive copy from Aug. 22, 2014, accessed via WaybackMachine.org on Dec. 10, 2015, with image of "Pampers Easy Ups".

Photos of Pampers EasyUps package, purchased at Kroger on Sep. 20, 2010.

* cited by examiner

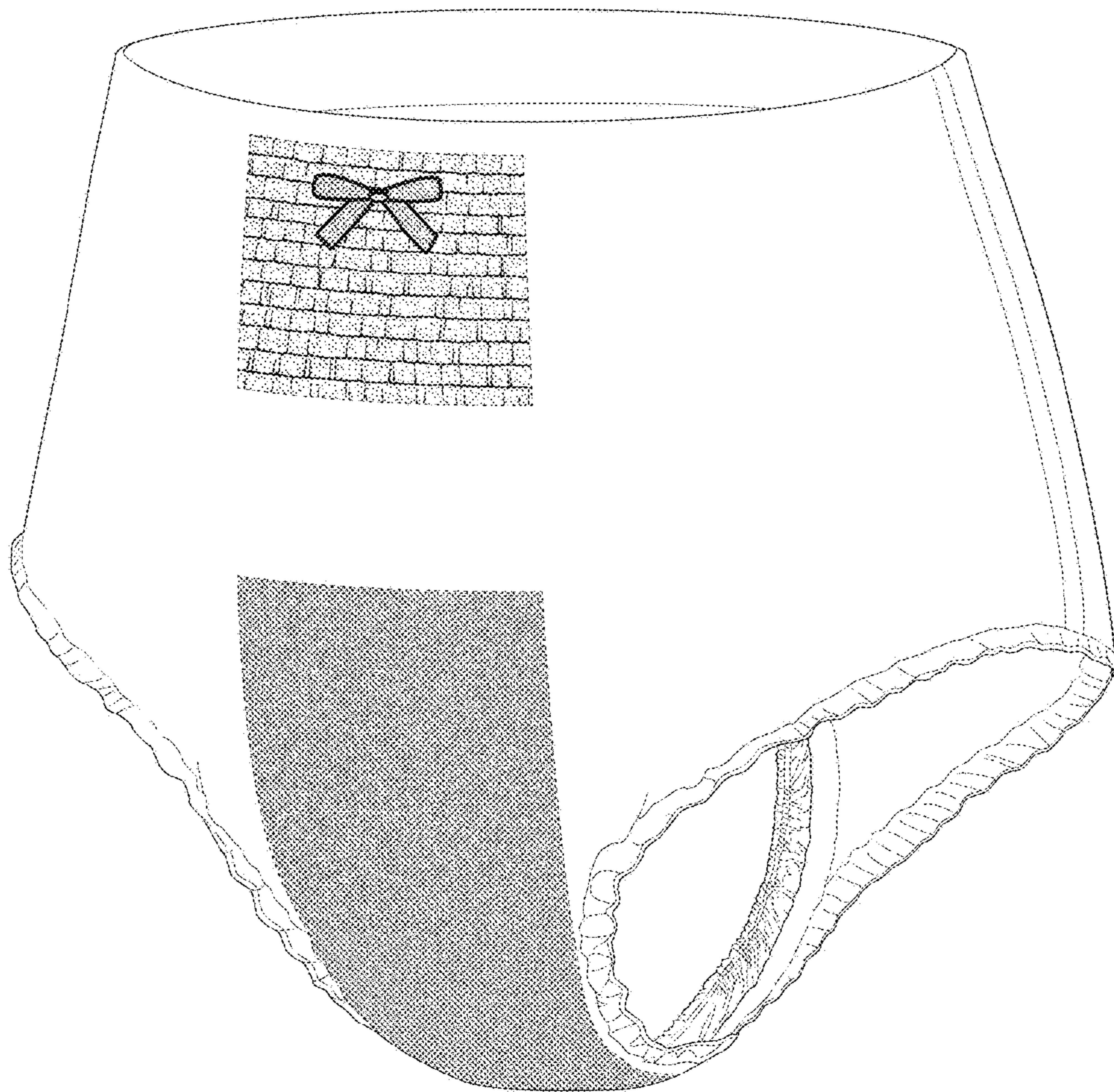

Fig. 1

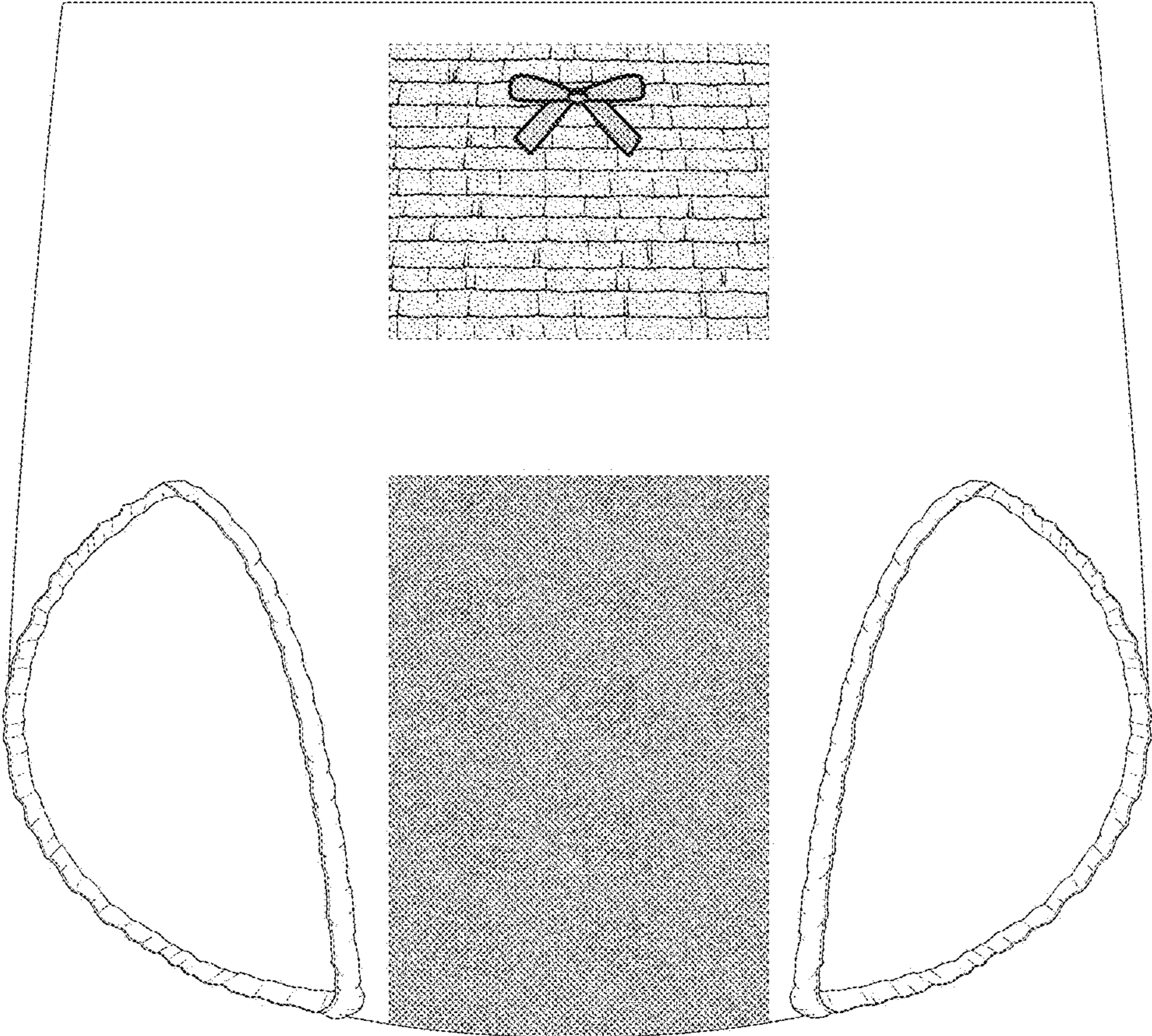

Fig. 2

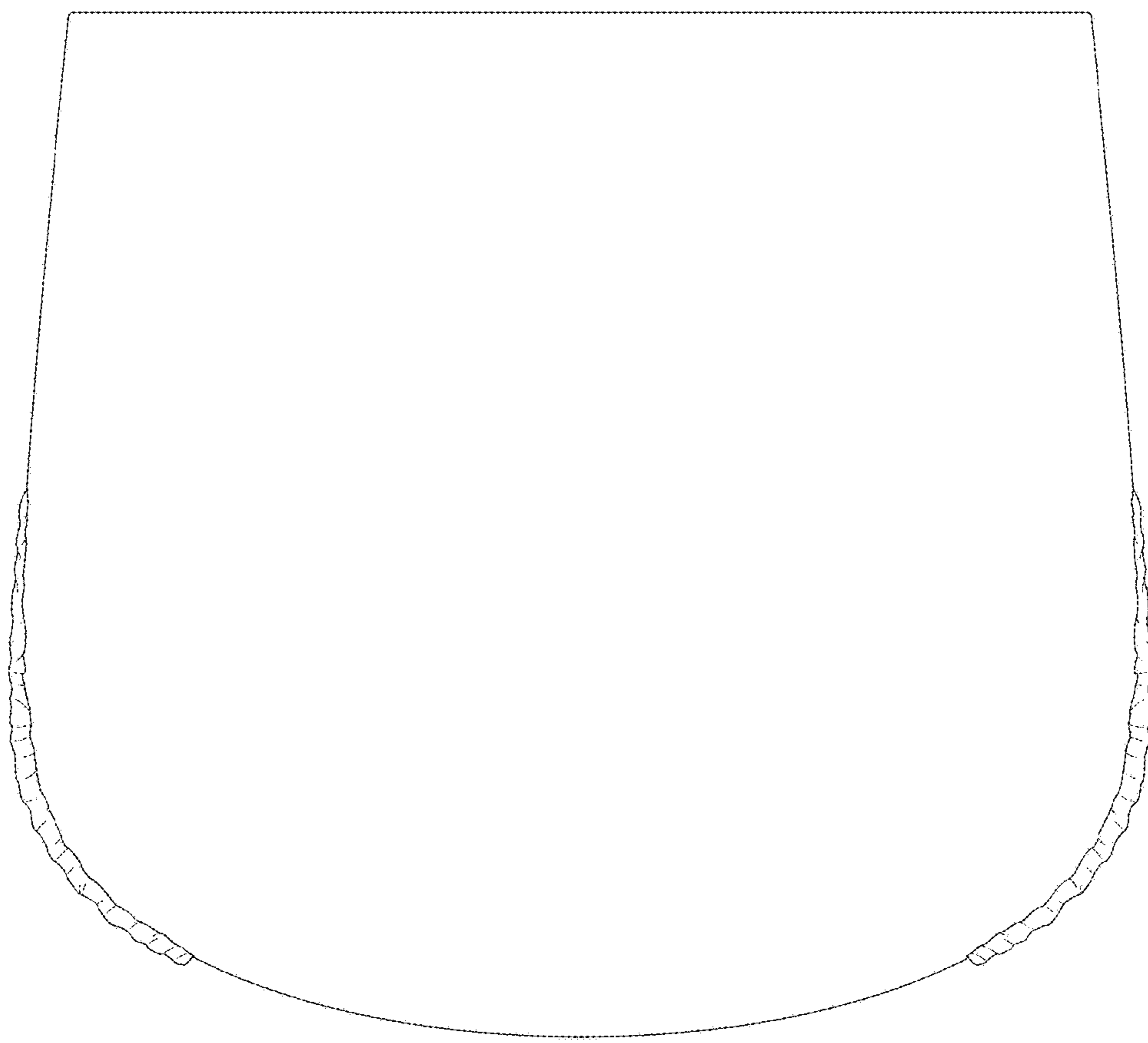

Fig. 3

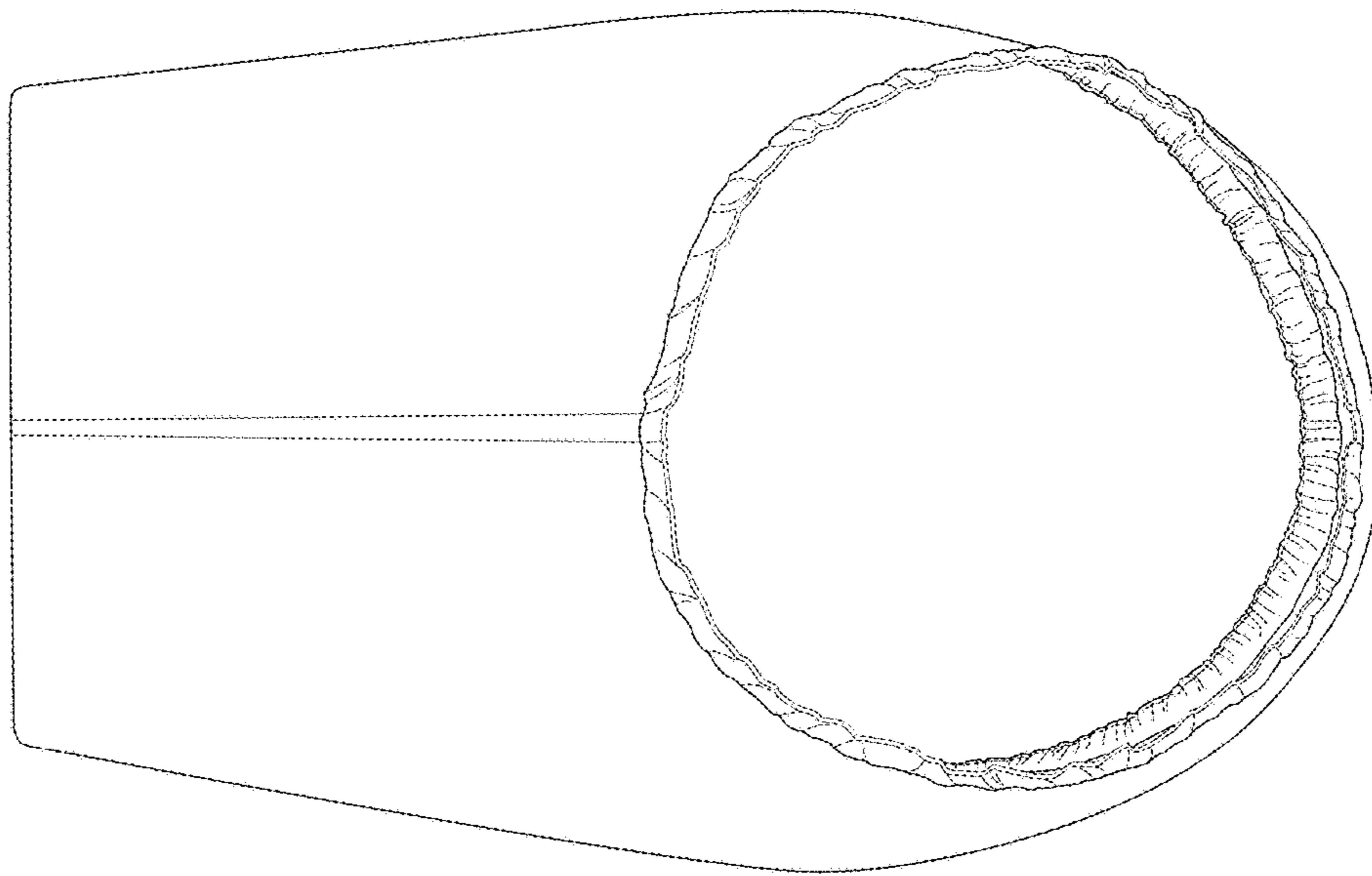

Fig. 5

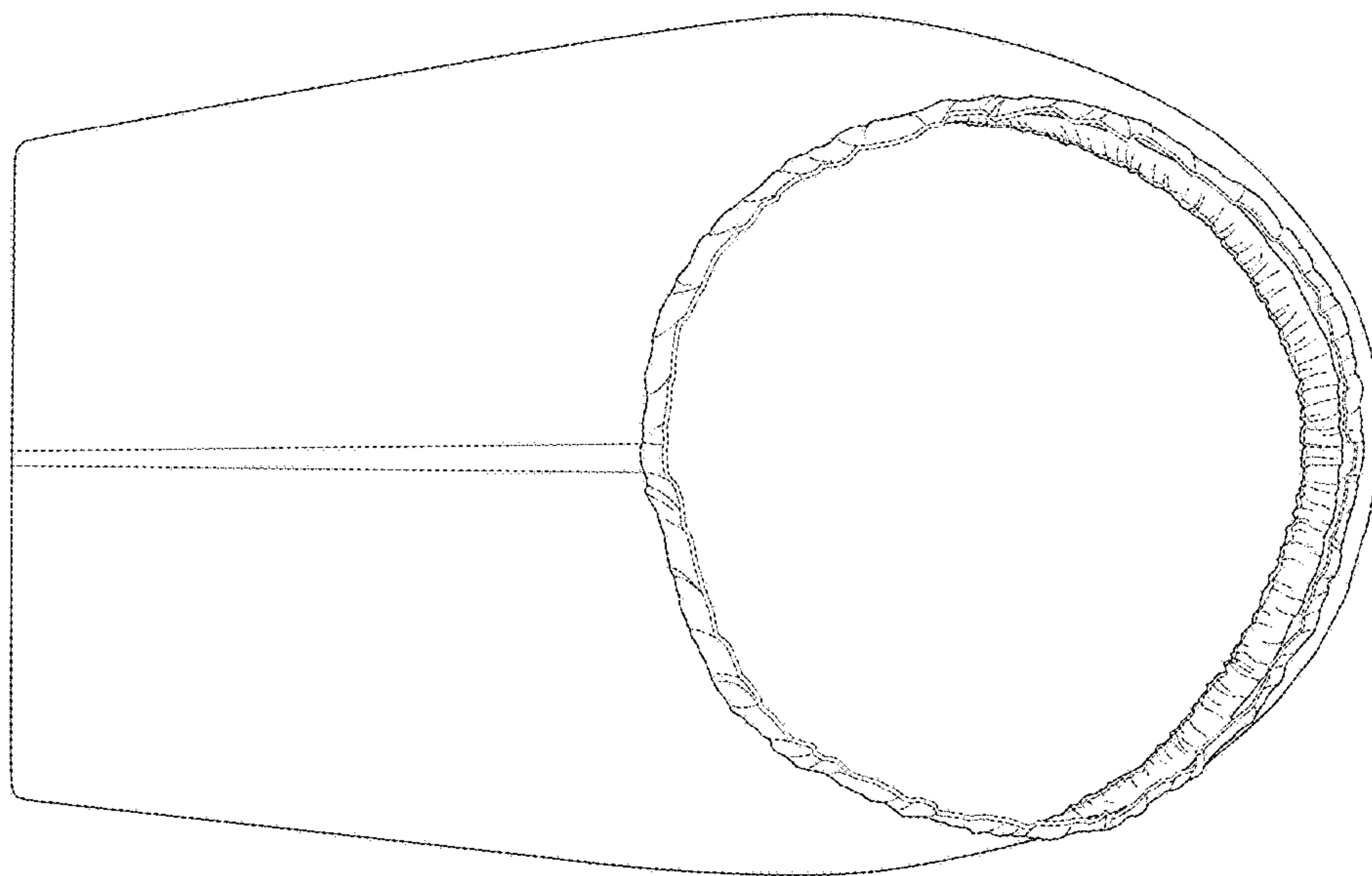

Fig. 4

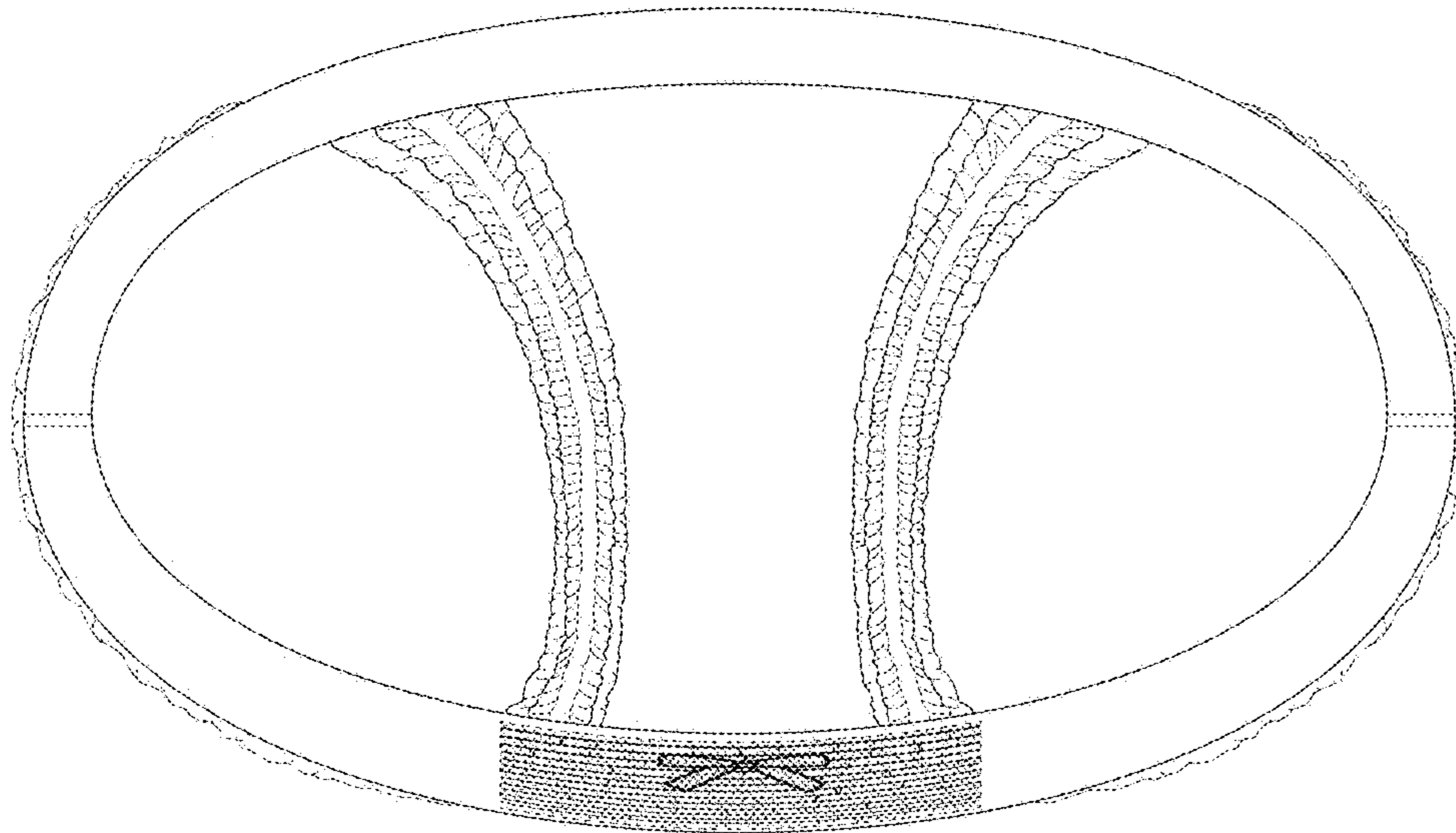

Fig. 6

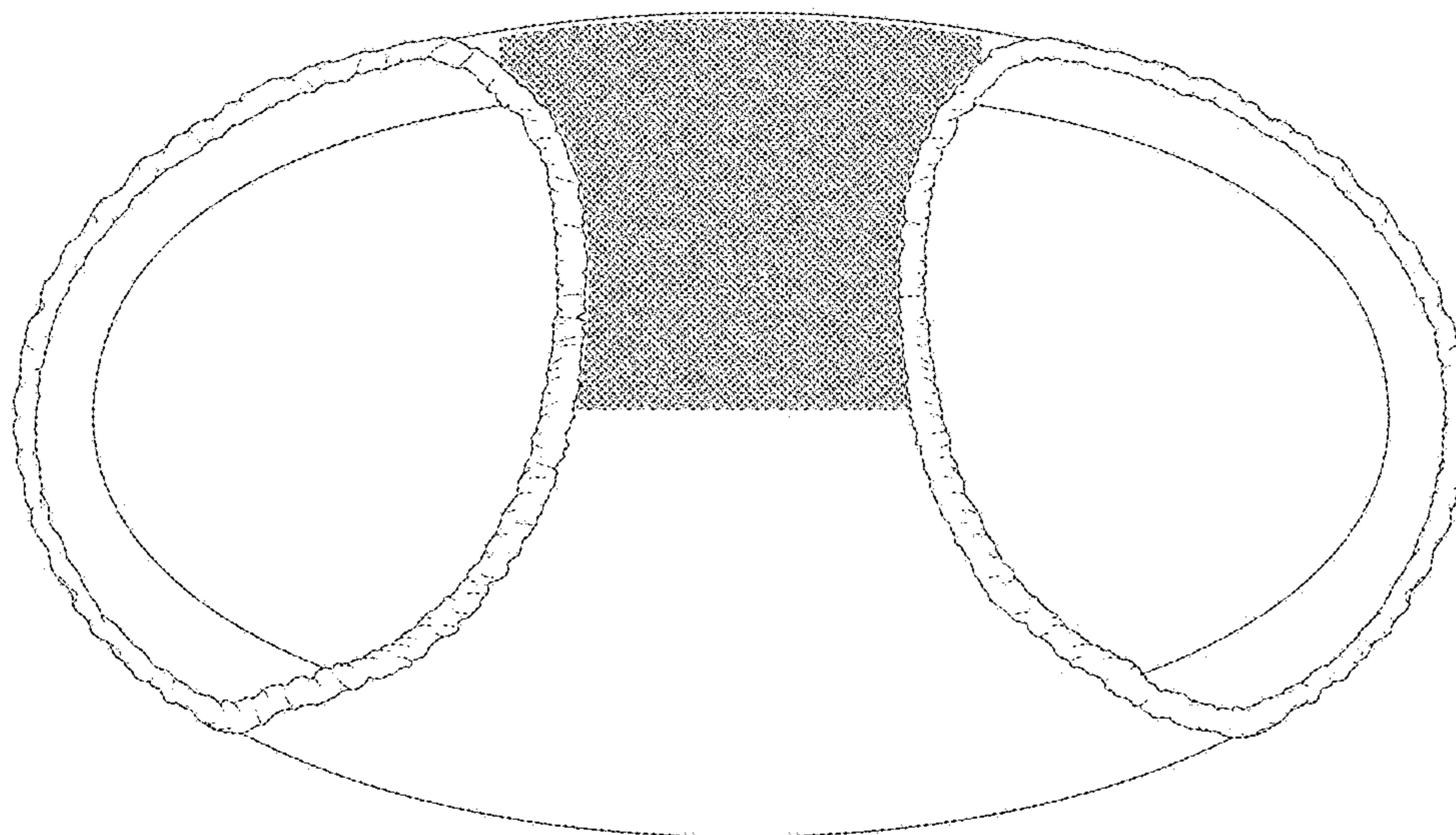

Fig. 7