



US00D806704S

(12) **United States Design Patent**
Lee et al.

(10) **Patent No.:** **US D806,704 S**
(45) **Date of Patent:** **** Jan. 2, 2018**

(54) **PORTABLE ELECTRONIC DEVICE**

FOREIGN PATENT DOCUMENTS

(71) Applicant: **Samsung Electronics Co., Ltd.**,
Suwon-si (KR)

EM 001359855-0001 2/2013
EM 002262667-0001 7/2013

(Continued)

(72) Inventors: **Yongyeon Lee**, Suwon-si (KR); **Ji-Yeon Kwak**, Seoul (KR); **Haeyoon Park**, Seoul (KR); **Kio Lee**, Seoul (KR)

OTHER PUBLICATIONS

(73) Assignee: **Samsung Electronics Co., Ltd.**,
Suwon-si (KR)

Latest Transparent Phone—Phones—Nairaland, posted Nov. 22, 2013, [retrieved Aug. 17, 2017]. Retrieved from Internet, <URL: <http://www.nairaland.com/1527260/latest-transparent-phone> >.*

(Continued)

(**) Term: **15 Years**

(21) Appl. No.: **29/554,388**

Primary Examiner — Barbara Fox

Assistant Examiner — Kristin E Reed

(22) Filed: **Feb. 11, 2016**

(74) *Attorney, Agent, or Firm* — NSIP Law

(30) **Foreign Application Priority Data**

Aug. 18, 2015 (KR) 30-2015-0041438

(51) **LOC (11) Cl.** **14-02**

(52) **U.S. Cl.**
USPC **D14/341**

(58) **Field of Classification Search**
USPC D14/341–347, 125–134, 137, 138 R, D14/138 AA, 138 AB, 138 C, 138 G, 147, D14/203.1, 203.3, 203.4, 203.7, 218, 247, D14/248, 332, 336, 371, 374–377, 388, D14/389, 315–318, 420, 426, 429, 440, D14/448, 450, 489, 492, 496; D6/300–310; D16/241; D18/6; D20/10, D20/19, 39; D21/329, 330
CPC . A63H 33/3016; G06F 1/1613; G06F 1/1641; G06F 1/1643; G06F 1/1647; G06F 3/04883; G06F 3/0486; G06F 3/04847;
(Continued)

(57) **CLAIM**

We claim the ornamental design for a portable electronic device, as shown and described.

DESCRIPTION

FIG. 1 is a front perspective view of a portable electronic device showing our new design;
FIG. 2 is a front view thereof;
FIG. 3 is a rear view thereof;
FIG. 4 is a left-side view thereof;
FIG. 5 is a right-side view thereof;
FIG. 6 is a top view thereof;
FIG. 7 is a bottom view thereof; and,
FIG. 8 is an enlarged view of the encircled portion shown in FIG. 1.

The short dash-dash broken lines in the figures depict portions of the portable electronic device that form no part of the claimed design.

The dot-dot-dash broken lines encircling portions of the claimed design that are illustrated in enlargements form no part of the claimed design.

(56) **References Cited**

U.S. PATENT DOCUMENTS

D506,937 S * 7/2005 Lee D10/65
D552,592 S * 10/2007 Deguchi D14/480.7

(Continued)

1 Claim, 8 Drawing Sheets

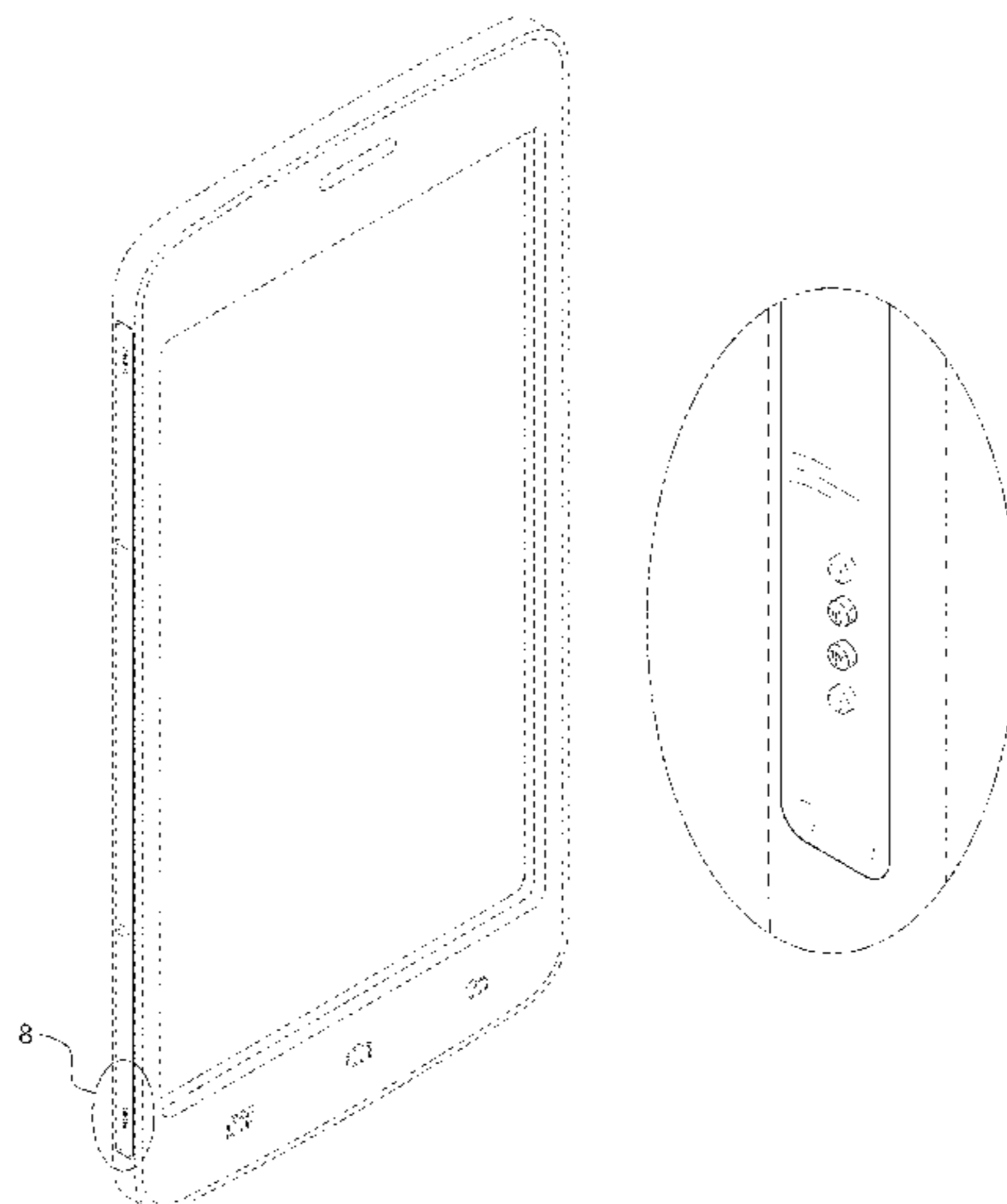

(58) **Field of Classification Search**

CPC G06F 3/04845; G06F 3/0484; G06F
3/04817; H05K 5/0004; H05K 5/0017;
H05K 5/02; H05K 5/0217; H04M 1/0279;
H04M 1/0281; H04M 1/0283; H04N
13/0459

See application file for complete search history.

(56)

References Cited

U.S. PATENT DOCUMENTS

D558,460	S *	1/2008	Yu	D14/341
D564,522	S *	3/2008	Kacin	D14/441
D583,810	S *	12/2008	Chen	D14/315
D584,302	S *	1/2009	Sogabe	D14/341
D629,798	S *	12/2010	Arie	D14/341
D639,269	S *	6/2011	Kim	D14/203.3
D641,016	S *	7/2011	Takahashi	D14/341
D657,331	S *	4/2012	Jung	D14/138 G
D664,516	S *	7/2012	Park	D14/138 AD
D675,209	S *	1/2013	Glanzer	D14/440
D677,660	S *	3/2013	Groene	D14/341
D689,455	S *	9/2013	Daniel	D10/65
D698,779	S *	2/2014	Kaula	D14/341
D702,681	S *	4/2014	Sugiyama	D14/341
D722,051	S *	2/2015	Inada	D14/341
D740,803	S *	10/2015	Yamazaki	D14/341
D744,595	S *	12/2015	Chapman	D20/39
D785,585	S *	5/2017	Ismail	D14/137
2012/0194448	A1 *	8/2012	Rothkopf	A45C 13/002 345/173

FOREIGN PATENT DOCUMENTS

KR	30-2011-0054753	11/2013
KR	30-2013-0049601	4/2014

OTHER PUBLICATIONS

Tony Stark's Transparent Phone Possible With Graphene?, posted Oct. 16, 2012, [retrieved Aug. 17, 2017]. Retrieved from Internet, <URL: <http://www.technovelgy.com/ct/Science-Fiction-News.asp?NewsNum=3785> >.*

Take a look through this transparent smartphone screen, posted May 31, 2012, [retrieved Aug. 17, 2017]. Retrieved from Internet, <URL: <https://www.cnet.com/news/changing-the-face-of-technology-women-in-technology/> >.*

Top 5-Inch Budget Android Phones, posted Feb. 20, 2013, [retrieved Aug. 17, 2017]. Retrieved from Internet, <URL: <http://www.indiatimes.com/technology/mobile/top-5inch-budget-android-phones-61857.html> >.*

"Mill sell folding mobile phone case for iphone 6+ Wholesale". [2015] www.mobofree.com. Mar. 30, 2015 <<http://www.mobofree.com/nigeria/Phones-tablets-mobile-devices/Accessories-Parts/mill-sell-folding-mobile-phone-case-for-iphone-6-WHOLESALE/1281620>>.

Nouske. "Nouske Flip Folio Wallet Stand up Lightweight Leather Cover with Magnetic Closure Auto Lock Feature for iPhone 6 plus 5.5-Inch(Gold)". [2016] www.amazon.com. Feb. 4, 2016 <http://www.amazon.com/Nouske-Magnetic-Sufficient-protection-Lightweight/dp/B00YBXDAUO/ref=sr_1_1?s=wireless&ie=UTF&qid=1437009936&sr=1-1&pebp=1437009940473&perid=1HVSV07DVWJP69N9M5P5>.

* cited by examiner

FIG. 1

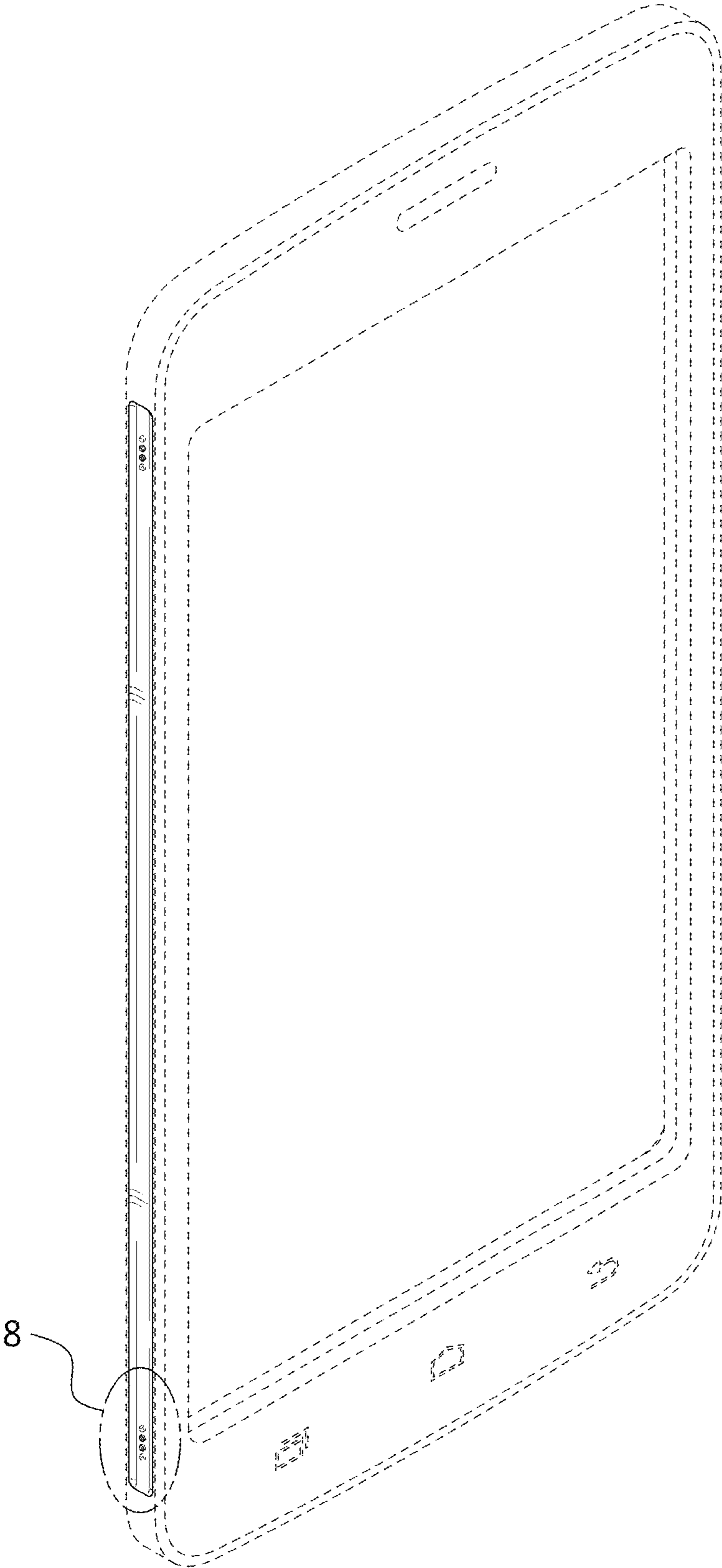

FIG. 2



FIG. 3

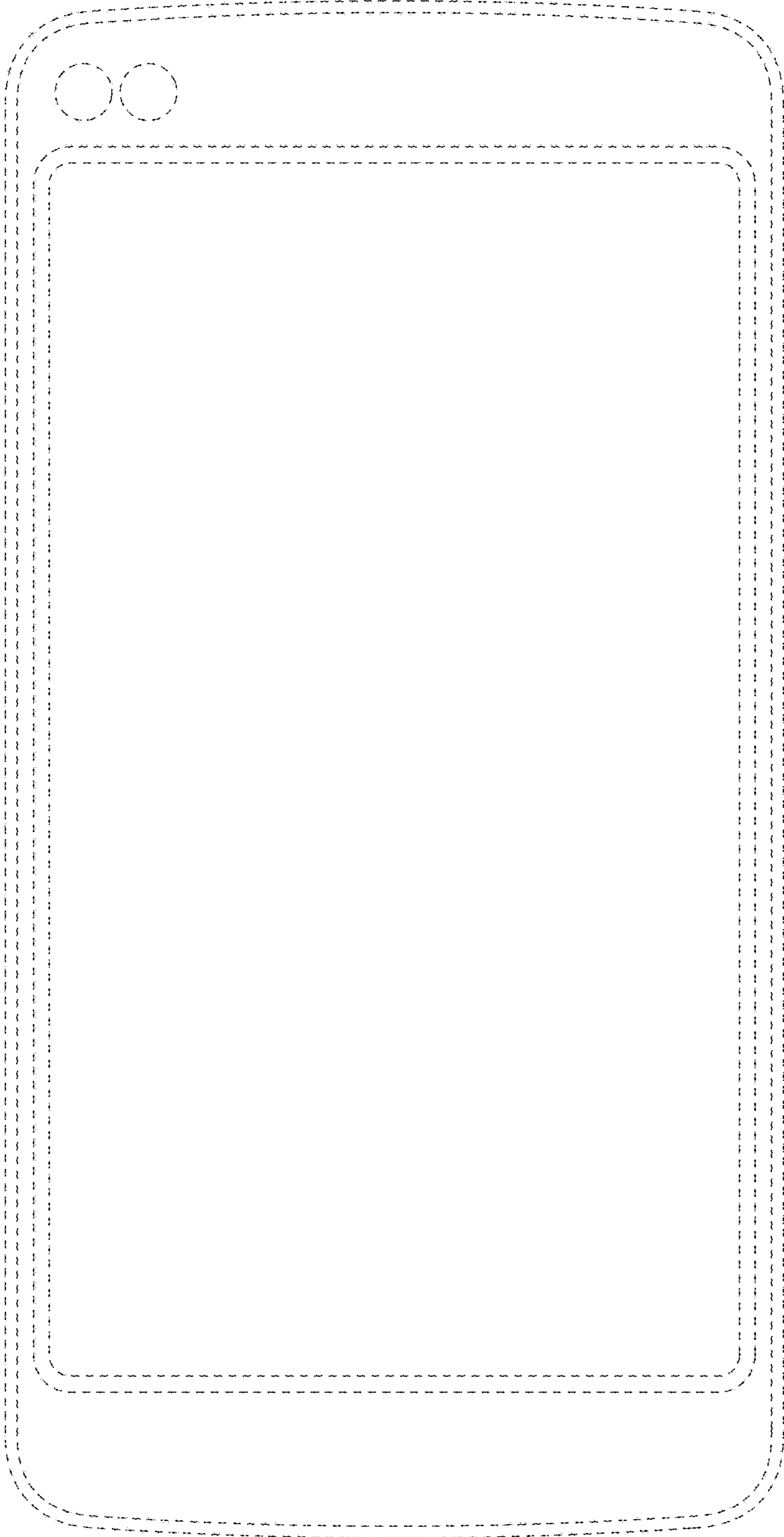

FIG. 4

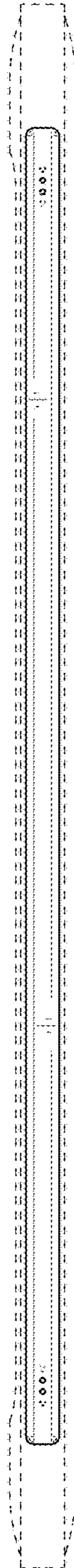

FIG. 5

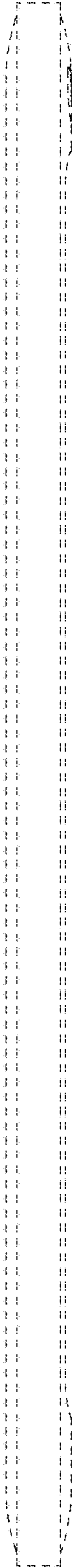

FIG. 6



FIG. 7

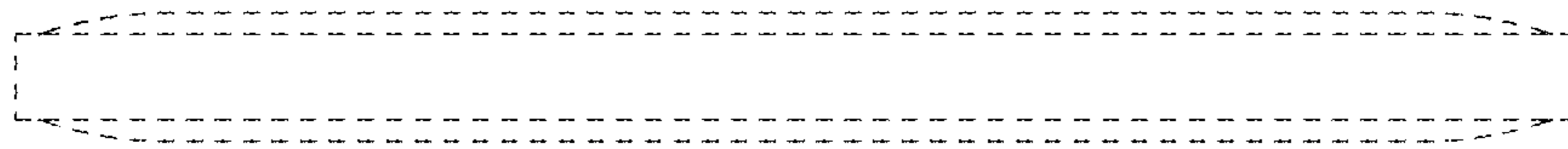

FIG. 8

