



US00D806659S

(12) **United States Design Patent**
Parekh

(10) **Patent No.:** **US D806,659 S**

(45) **Date of Patent:** **** *Jan. 2, 2018**

(54) **SOLDER PAD**

(71) Applicant: **Lumileds Holding B.V.**, Schiphol (NL)

(72) Inventor: **Ketan S. Parekh**, San Jose, CA (US)

(73) Assignee: **LUMILEDS HOLDING B.V.**,
Schiphol (NL)

(*) Notice: This patent is subject to a terminal disclaimer.

(**) Term: **15 Years**

(21) Appl. No.: **29/550,887**

(22) Filed: **Jan. 7, 2016**

(51) **LOC (11) Cl.** **13-03**

(52) **U.S. Cl.**
USPC **D13/182**

(58) **Field of Classification Search**
USPC D13/120, 121, 133, 162, 179, 180, 182;
D14/130, 486; D26/1; D15/144.2
CPC H05K 1/111-1/114
See application file for complete search history.

(56) **References Cited**

U.S. PATENT DOCUMENTS

D615,052 S *	5/2010	Imai	D13/180
D637,564 S *	5/2011	Tseng	D13/180
D650,760 S *	12/2011	Hussell	D13/180
D676,000 S *	2/2013	Hussell	D13/180
D676,395 S *	2/2013	Hussell	D13/180
D682,224 S *	5/2013	Sasano	D13/180
D689,451 S *	9/2013	Shimonishi	D13/180
D695,239 S *	12/2013	Ko	D13/180
D698,322 S *	1/2014	Takeda	D13/180
D700,585 S *	3/2014	Takeda	D13/180
D706,231 S *	6/2014	Hussell	D13/180
D707,192 S *	6/2014	Hussell	D13/180
D709,040 S *	7/2014	Chen	D13/180
D709,041 S *	7/2014	Yu	D13/180
D712,850 S *	9/2014	Welch	D13/180

D717,252 S *	11/2014	Takeda	D13/180
D721,339 S *	1/2015	Hussell	D13/180
D739,565 S *	9/2015	Welch	D26/1
D748,067 S *	1/2016	Gumhold	D13/180
D748,292 S *	1/2016	Fragner	D26/1
D766,471 S *	9/2016	Wimmer	D13/180

(Continued)

OTHER PUBLICATIONS

Luxeon HR30. [online] Published date unknown. Retrieved on Oct. 5, 2016 from <URL: <http://textlab.io/doc/1877434/luxeon-tx-application-brief>>.*

Primary Examiner — Vy Koenig

Assistant Examiner — Omeed Agilee

(74) *Attorney, Agent, or Firm* — Volpe and Koenig, P.C.

(57) **CLAIM**

The ornamental design for a solder pad, as shown and described.

DESCRIPTION

FIG. 1 is a front, left, and top perspective view of a first embodiment of a solder pad in accordance with my design; FIG. 2 is a top plan view thereof; FIG. 3 is a front elevation view thereof; FIG. 4 is a rear elevation view thereof; FIG. 5 is a left elevation view thereof; and FIG. 6 is a right elevation view thereof; FIG. 7 is a front, left, and top perspective view of a second embodiment of a solder pad in accordance with my design. FIG. 8 is a top plan view thereof; FIG. 9 is a front elevation view thereof; FIG. 10 is a rear elevation view thereof; FIG. 11 is a left elevation view thereof; and FIG. 12 is a right elevation view thereof. All broken lines shown in the drawings depict portions of the solder pad that form no part of the claimed design.

1 Claim, 6 Drawing Sheets

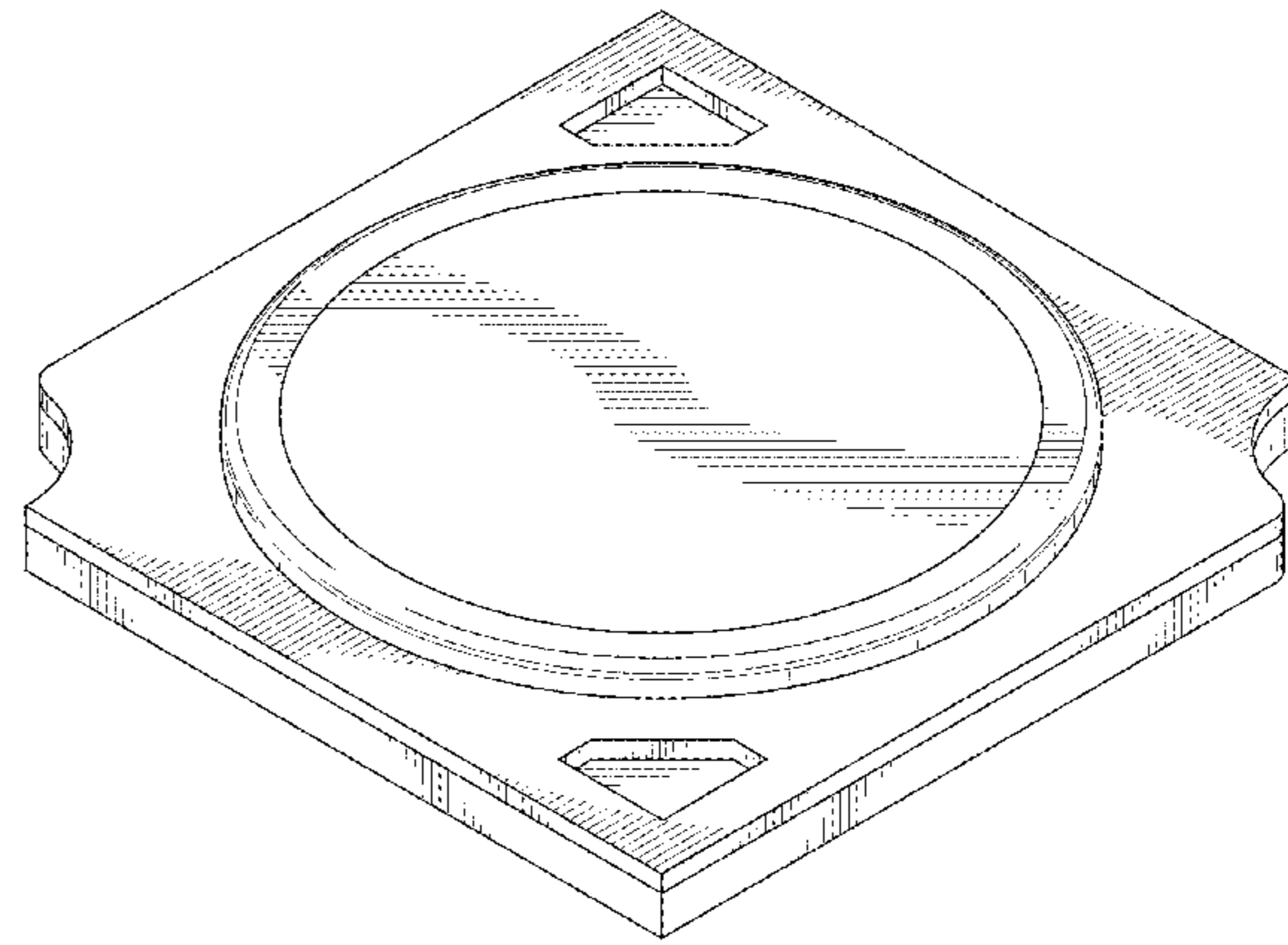
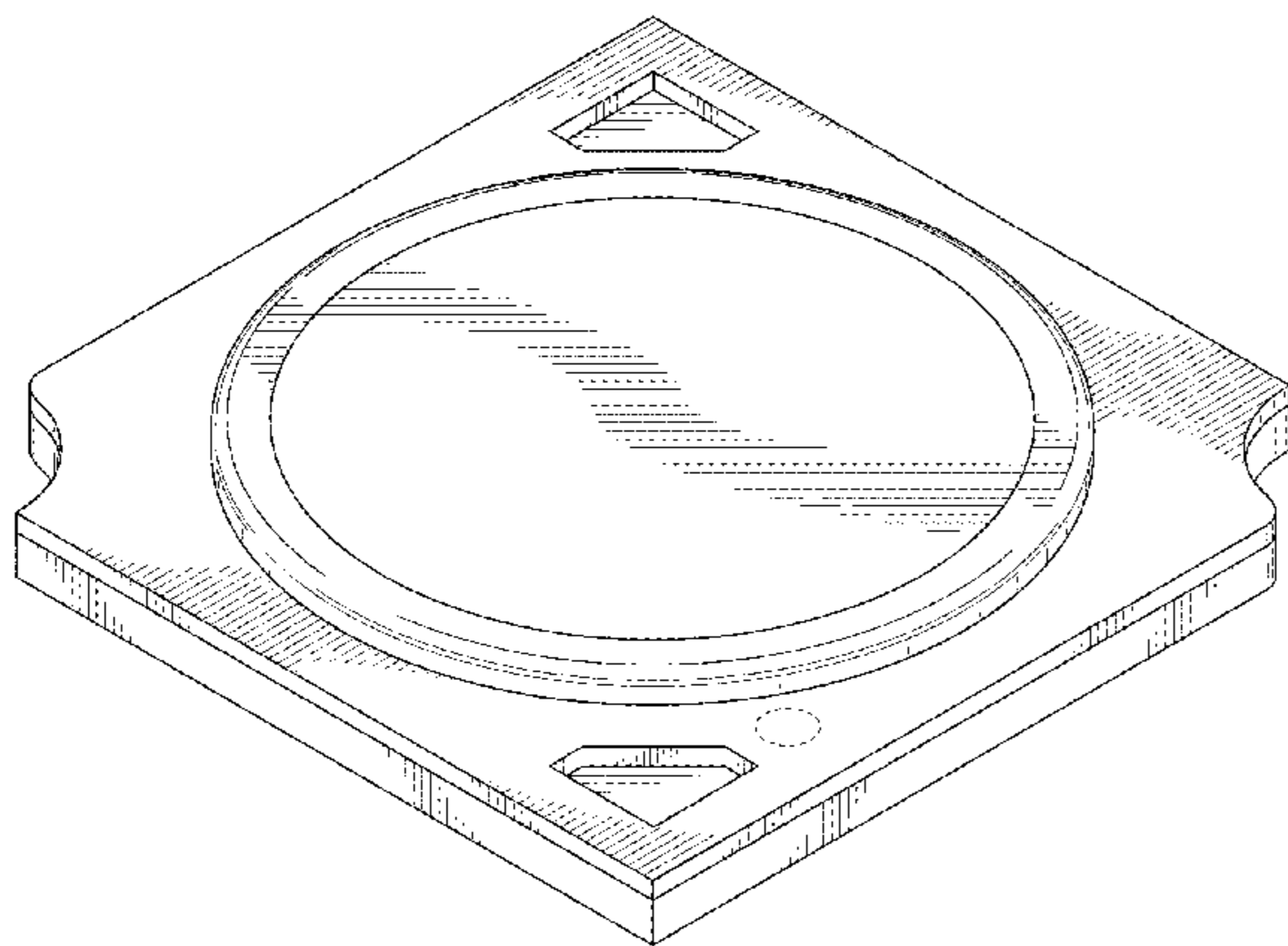

(56)

References Cited

U.S. PATENT DOCUMENTS

D767,515 S * 9/2016 Eguchi D13/180
2014/0217433 A1 * 8/2014 Tudorica H01L 33/56
257/89

* cited by examiner

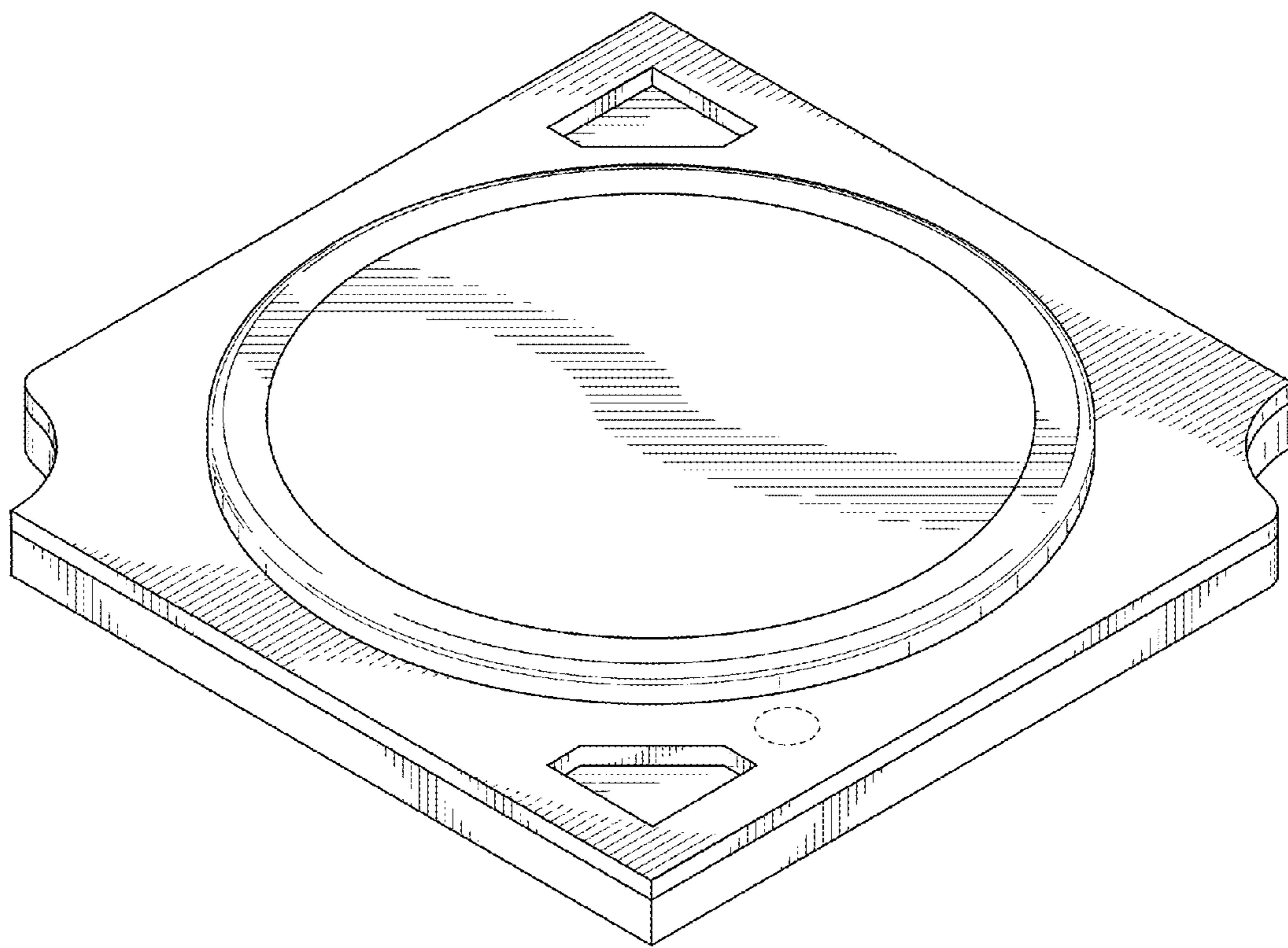

FIG. 1

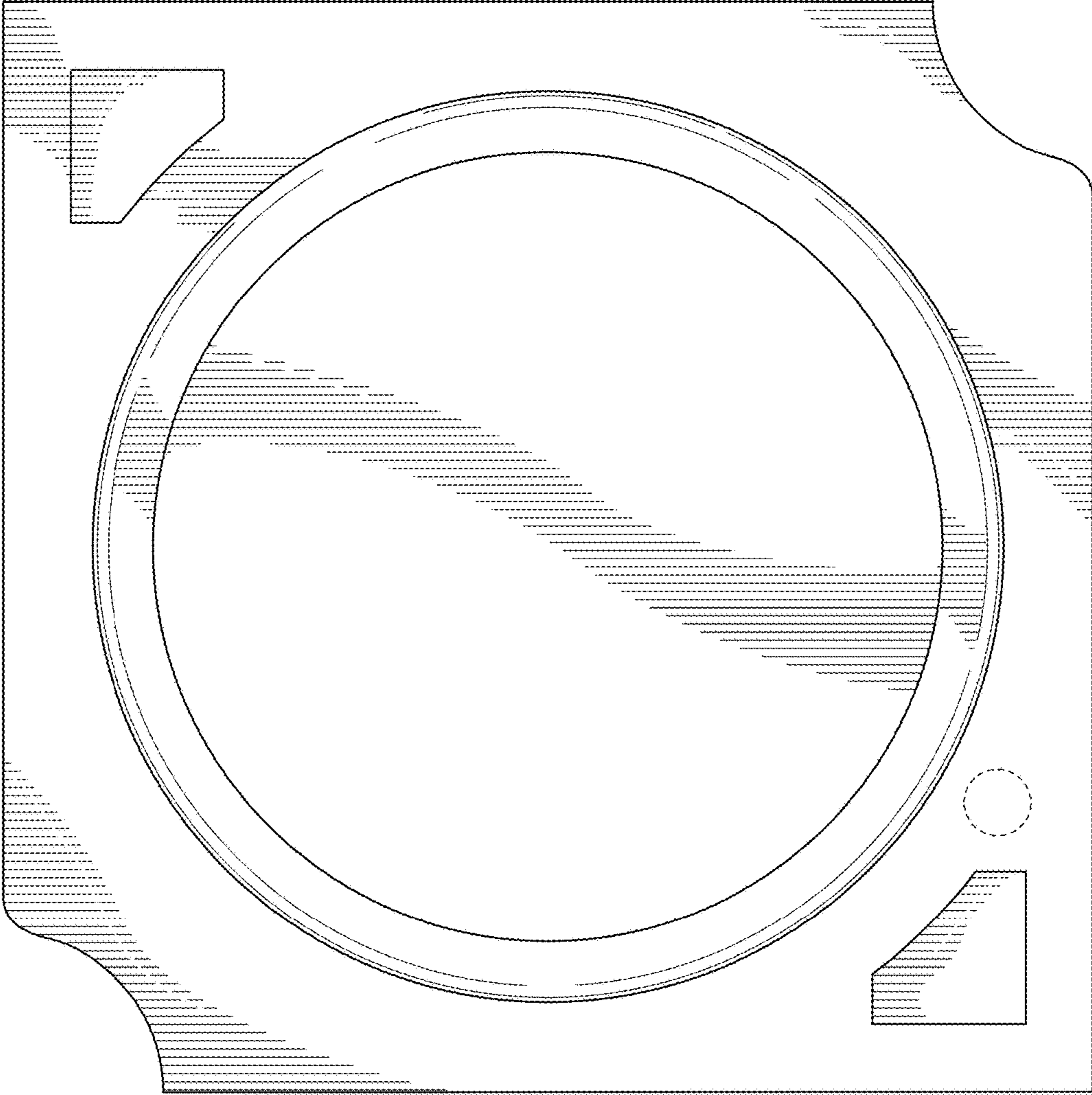

FIG. 2

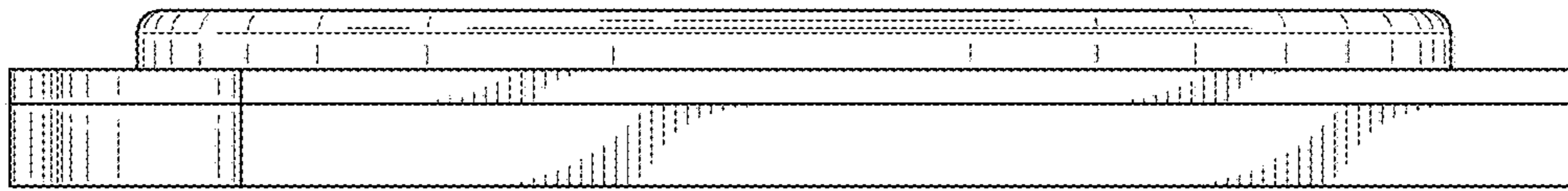

FIG. 3

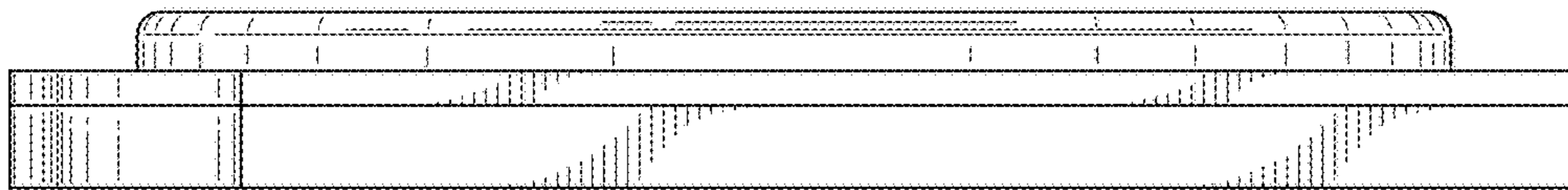

FIG. 4

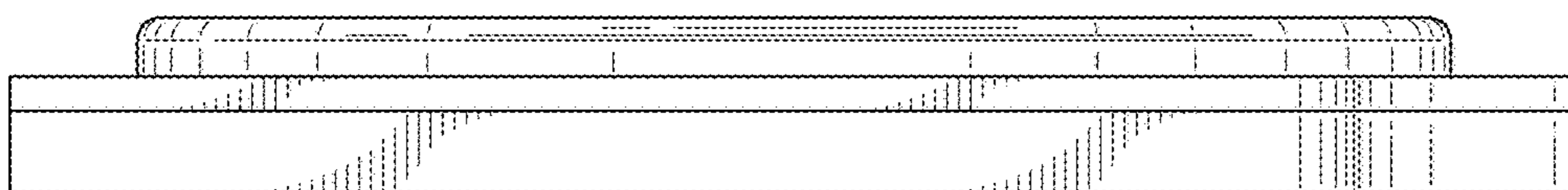

FIG. 5

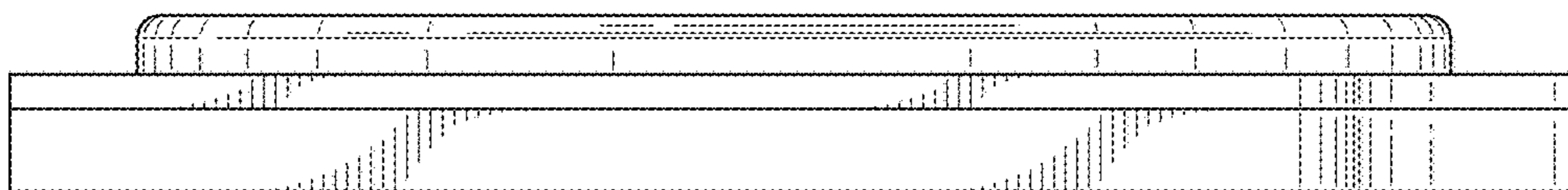

FIG. 6

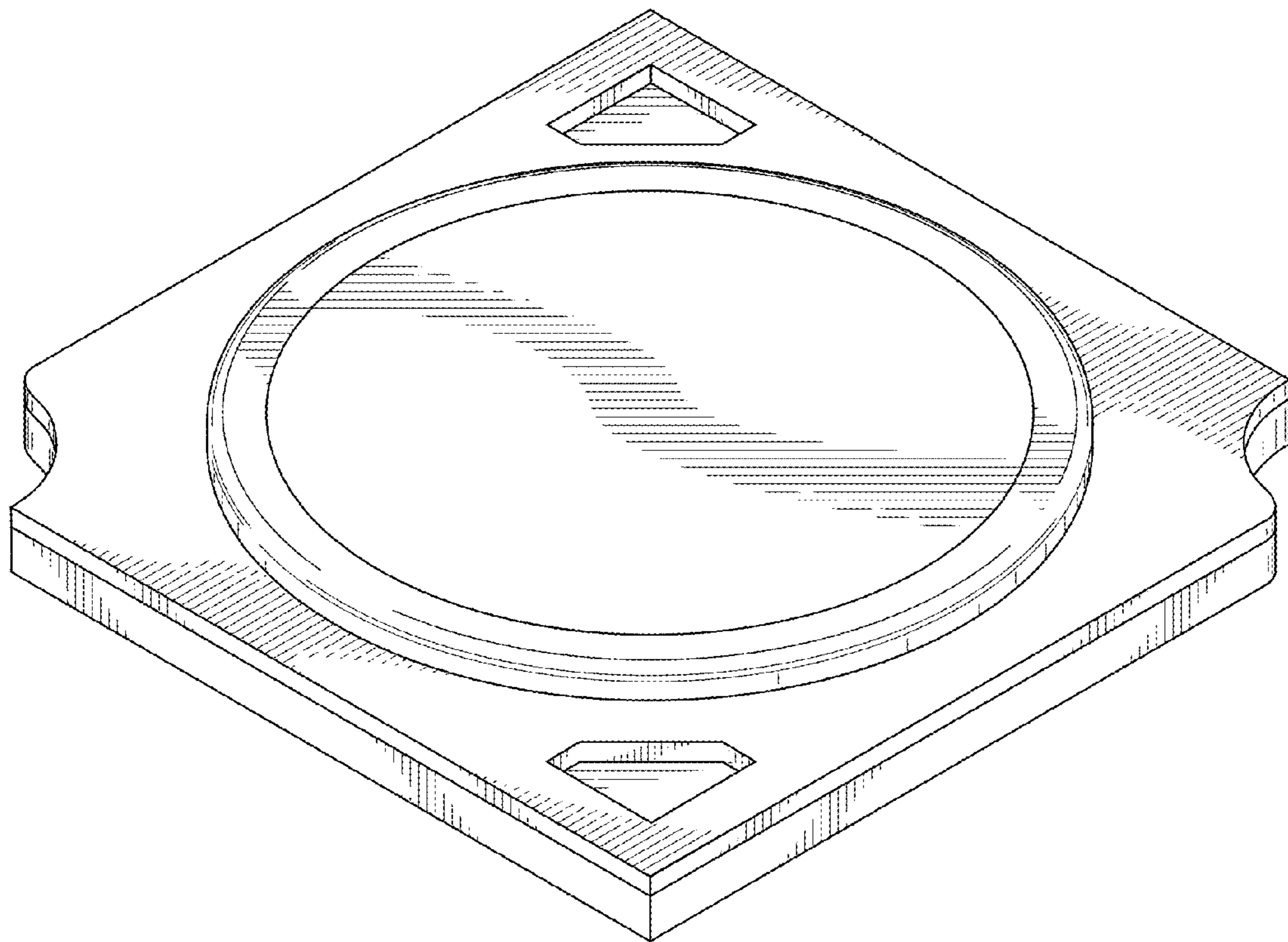

FIG. 7

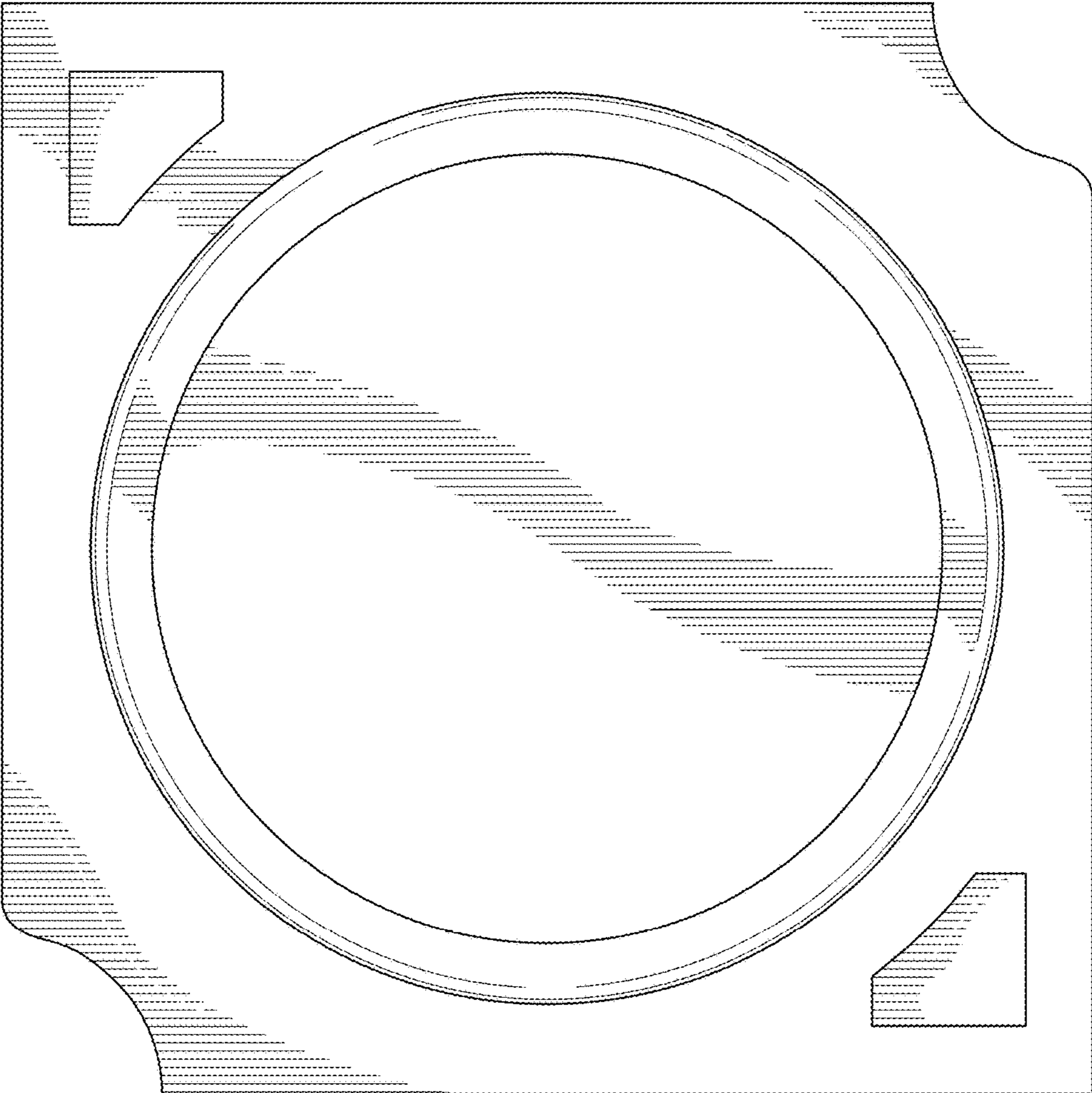

FIG. 8

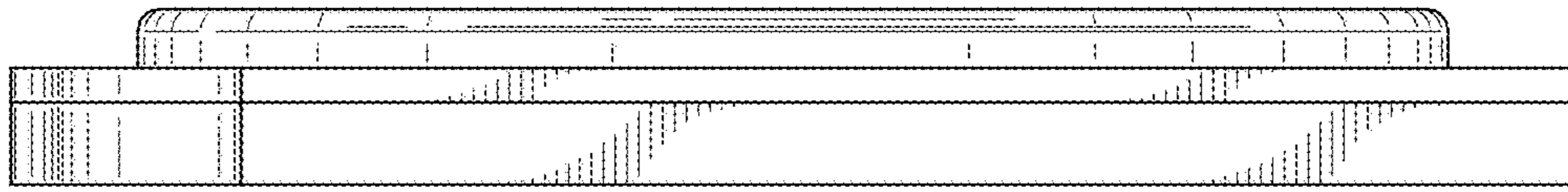

FIG. 9

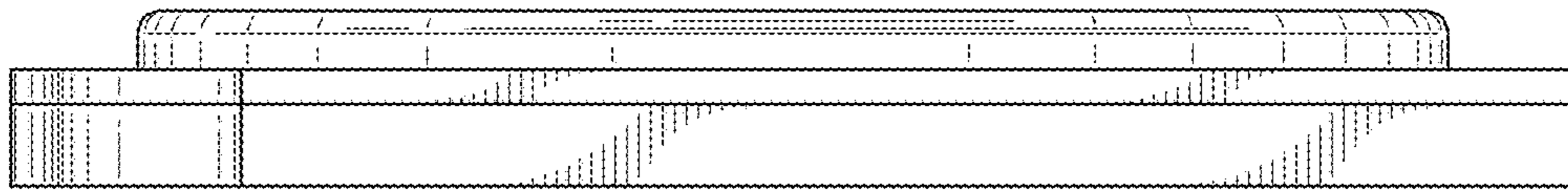

FIG. 10

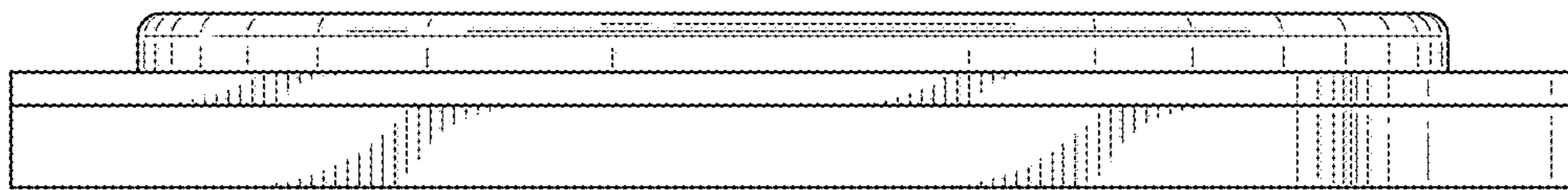

FIG. 11

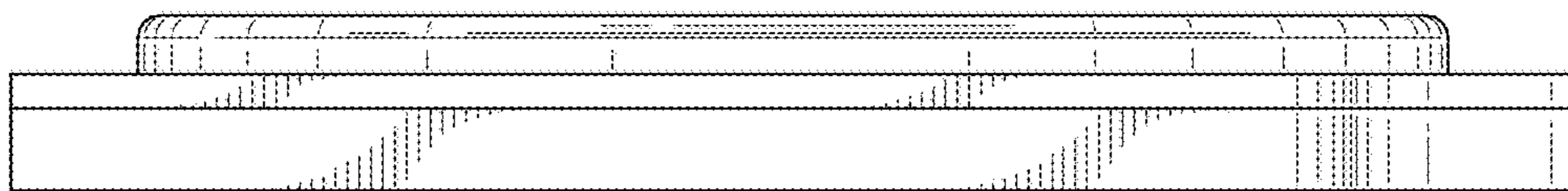

FIG. 12