



US00D806611S

(12) **United States Design Patent**
Alamdar

(10) **Patent No.:** **US D806,611 S**

(45) **Date of Patent:** **** *Jan. 2, 2018**

- (54) **SIDE BAG FOR MOTORCYCLE**
- (71) Applicant: **Husnain Alamdar**, Walnut, CA (US)
- (72) Inventor: **Husnain Alamdar**, Walnut, CA (US)
- (73) Assignee: **CRORAMA, INC.**, Walnut, CA (US)
- (*) Notice: This patent is subject to a terminal disclaimer.
- (**) Term: **14 Years**
- (21) Appl. No.: **29/517,610**
- (22) Filed: **Feb. 13, 2015**
- (51) **LOC (11) Cl.** **12-11**
- (52) **U.S. Cl.**
USPC **D12/114**
- (58) **Field of Classification Search**
USPC D12/114, 110, 409, 407, 410; D3/231, D3/273
CPC B62J 9/00; B62J 9/001; B62J 9/006; B62J 9/008; B62J 7/00
See application file for complete search history.

D675,557 S *	2/2013	Harris	D12/410
D688,195 S *	8/2013	Robinson	D12/409
D710,604 S *	8/2014	Alamdar	D3/231
D710,605 S *	8/2014	Alamdar	D3/231
D710,606 S *	8/2014	Alamdar	D3/231
D711,093 S *	8/2014	Alamdar	D3/231
D743,163 S *	11/2015	Alamdar	D3/231
D743,325 S *	11/2015	Seo	D12/410
D743,696 S *	11/2015	Alamdar	D3/231

* cited by examiner

Primary Examiner — George D. Kirschbaum

Assistant Examiner — Clese Moore, Jr.

(57) **CLAIM**

I claim the ornamental design for a side bag for motorcycle according to the claimed design, as shown and described.

DESCRIPTION

FIG. 1 is a perspective view of a side bag for motorcycle according to the claimed design;
 FIG. 2 is a back view of a side bag for motorcycle according to the claimed design.
 FIG. 3 is a front view of a side bag for motorcycle according to the claimed design.
 FIG. 4 is a top view of a side bag for motorcycle according to the claimed design.
 FIG. 5 is a bottom view of a side bag for motorcycle according to the claimed design.
 FIG. 6 is a right view of a side bag for motorcycle according to the claimed design.
 FIG. 7 is a left view of a side bag for motorcycle according to the claimed design; and,
 FIG. 8 is a left view of a side bag for motorcycle in the open position according to the claimed design.
 The broken lines illustrated show portions of the side bag for motorcycle that form no part of the claimed design.

1 Claim, 8 Drawing Sheets

(56) **References Cited**

U.S. PATENT DOCUMENTS

D262,103 S *	12/1981	Beaubien	D12/410
D346,144 S *	4/1994	Katz	D12/409
D371,537 S *	7/1996	Jennings	D12/409
D460,388 S *	7/2002	Price	D12/114
D461,761 S *	8/2002	Monson	D12/410
D465,762 S *	11/2002	Wargin	D12/410
D497,341 S *	10/2004	Hanagan	D12/410
D506,968 S *	7/2005	Berardino	D12/410
D550,146 S *	9/2007	Hanagan	D12/410
D600,190 S *	9/2009	Sharpe, Jr.	D12/410
D618,612 S *	6/2010	Asao	D12/409
D654,845 S *	2/2012	Yonai	D12/409

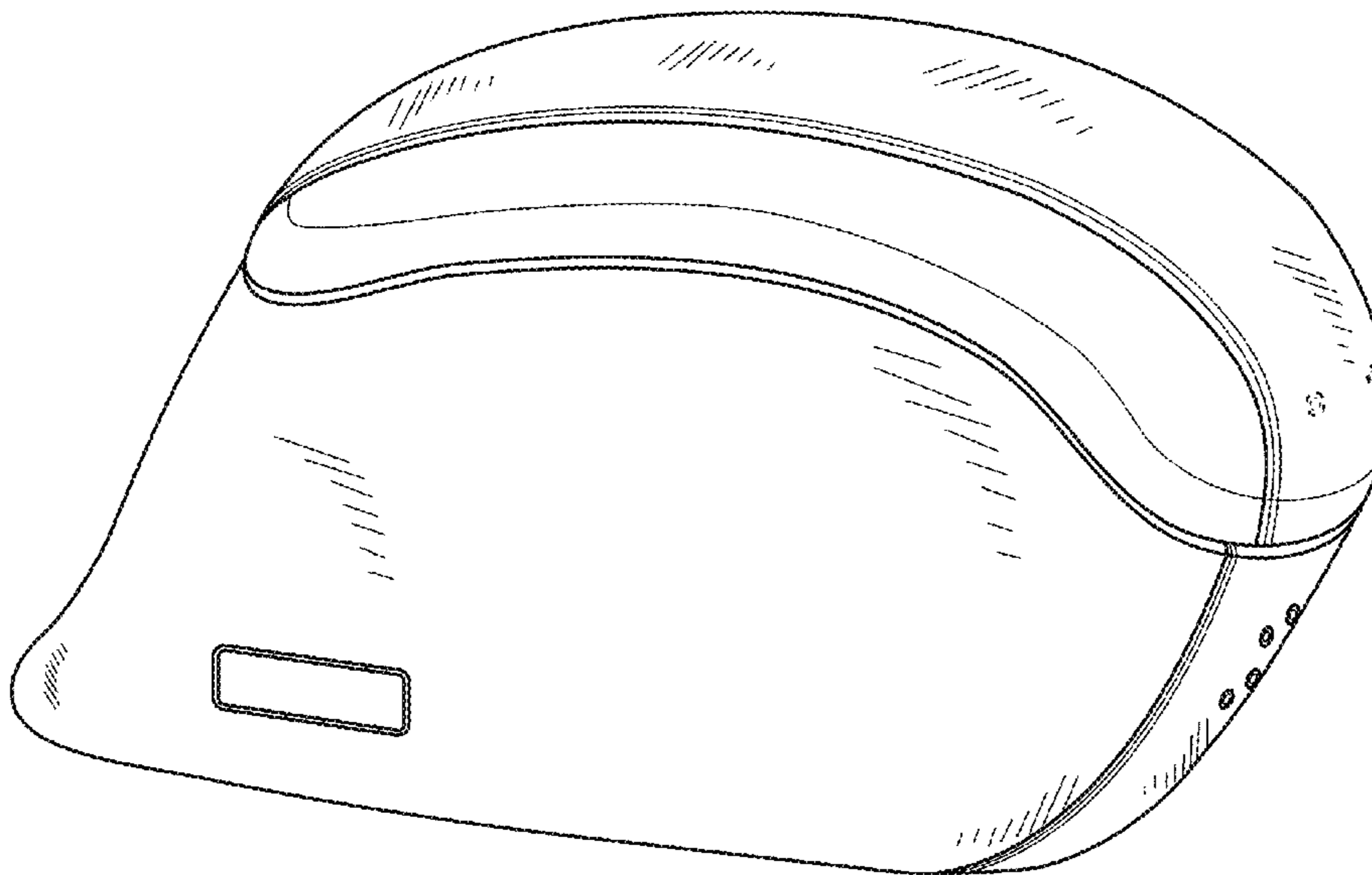

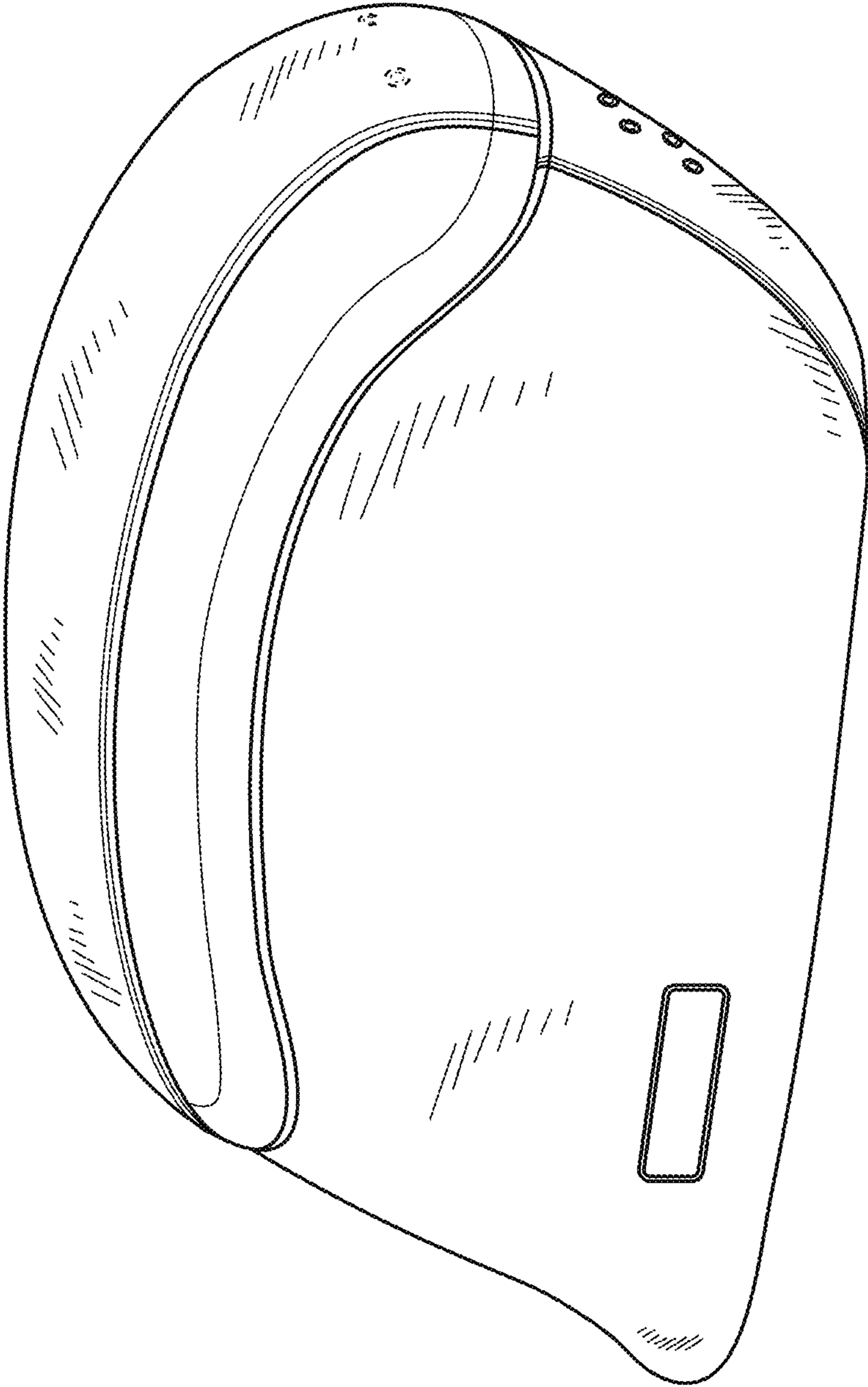

FIG. 1

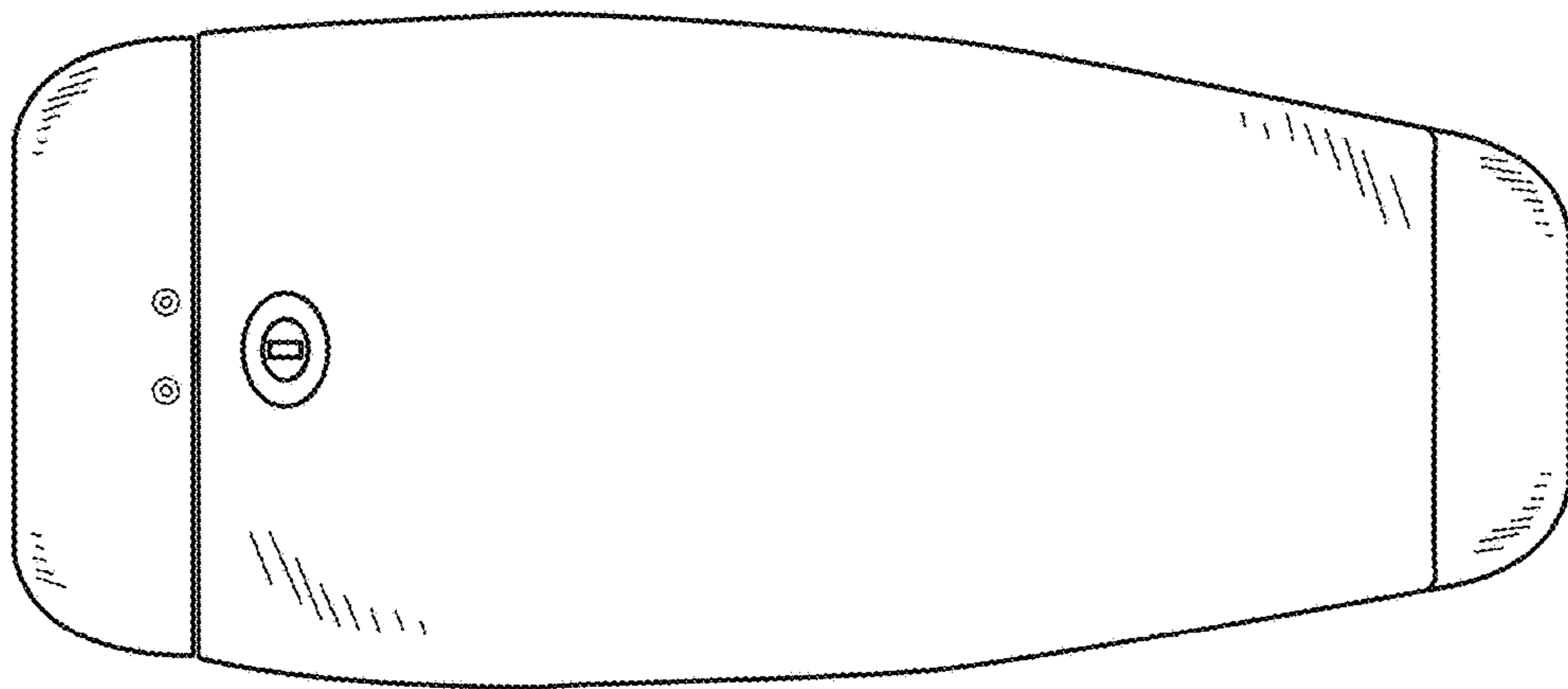

FIG. 2

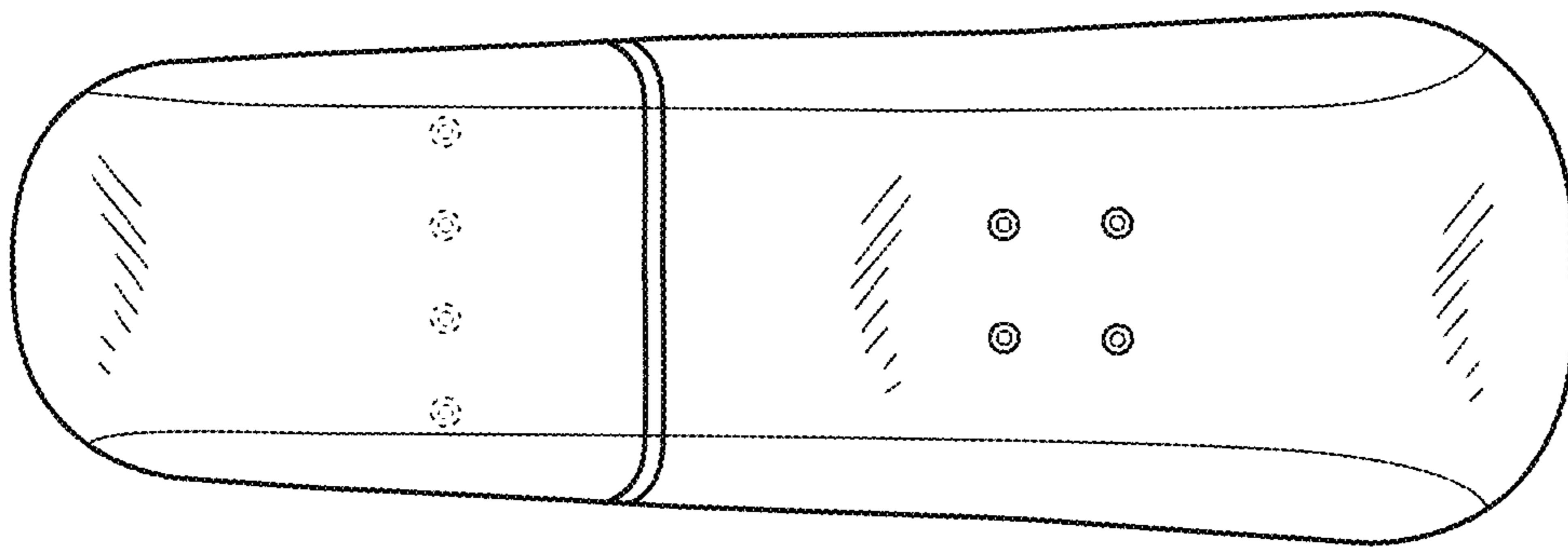

FIG. 3

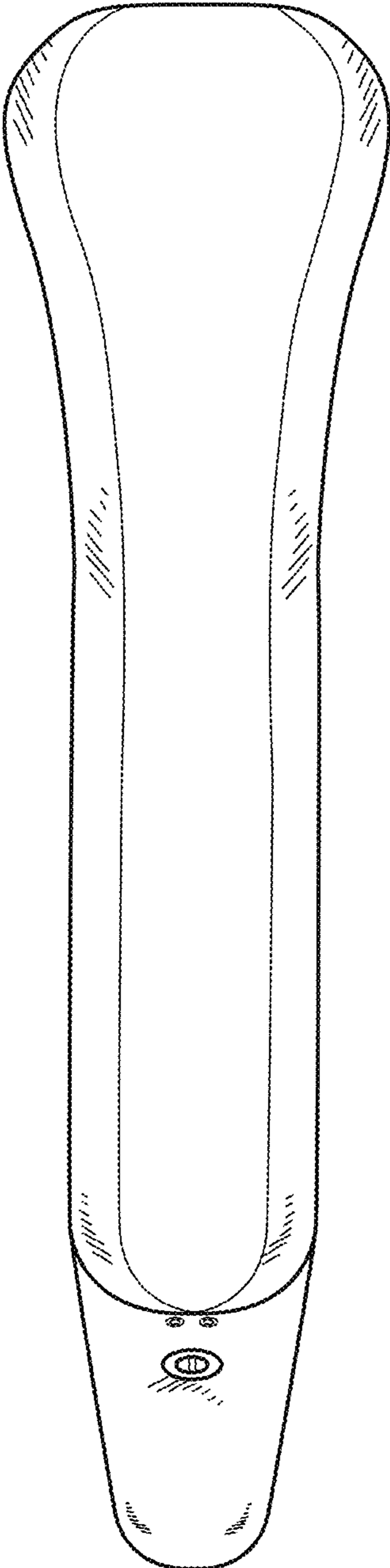

FIG. 4

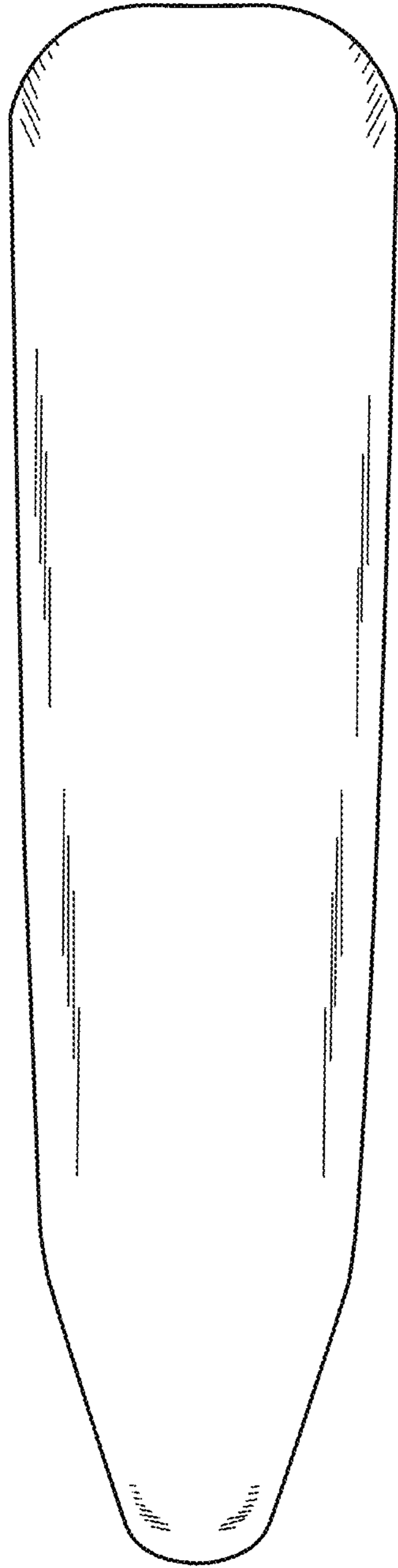

FIG. 5

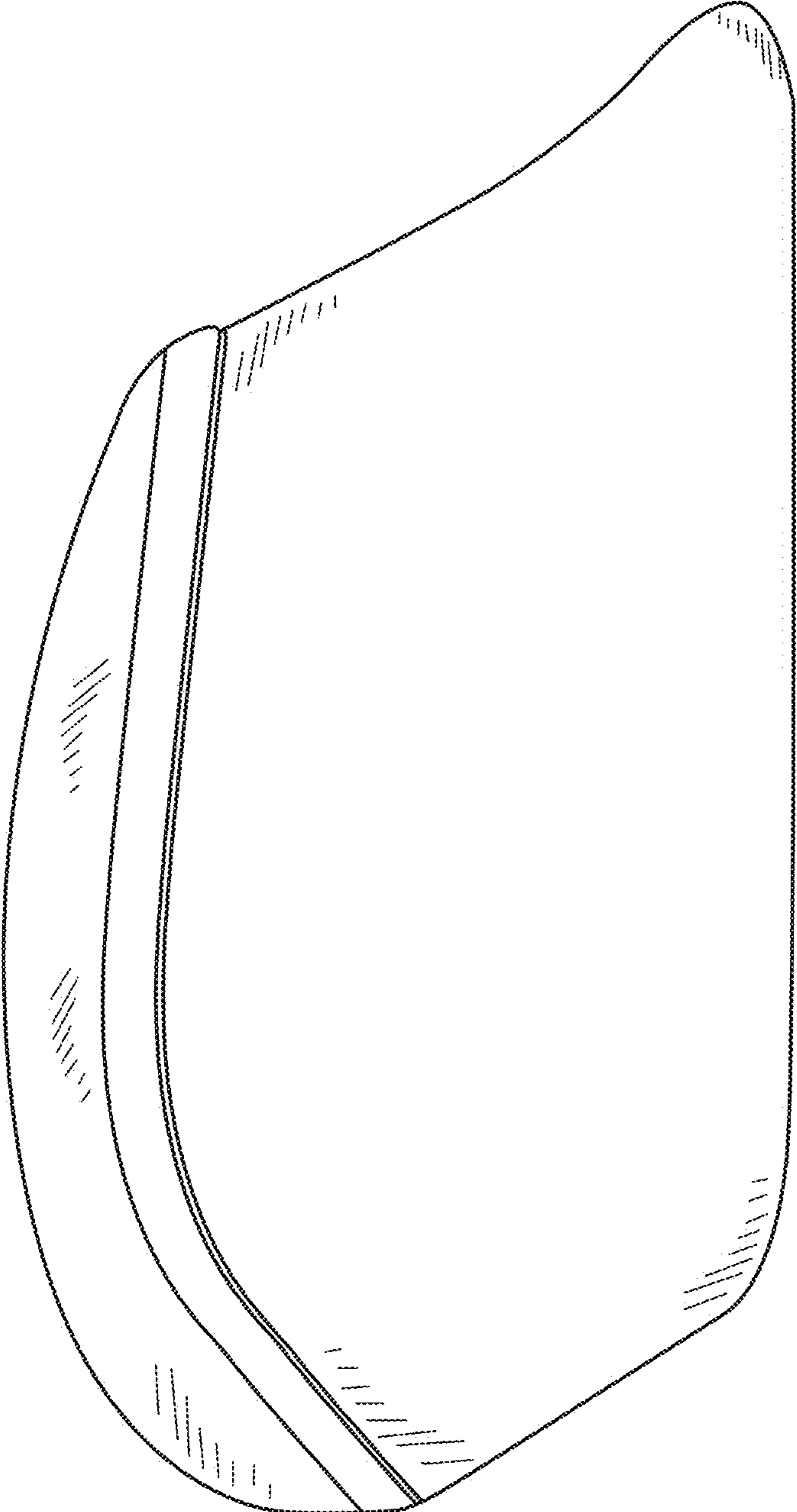

FIG. 6

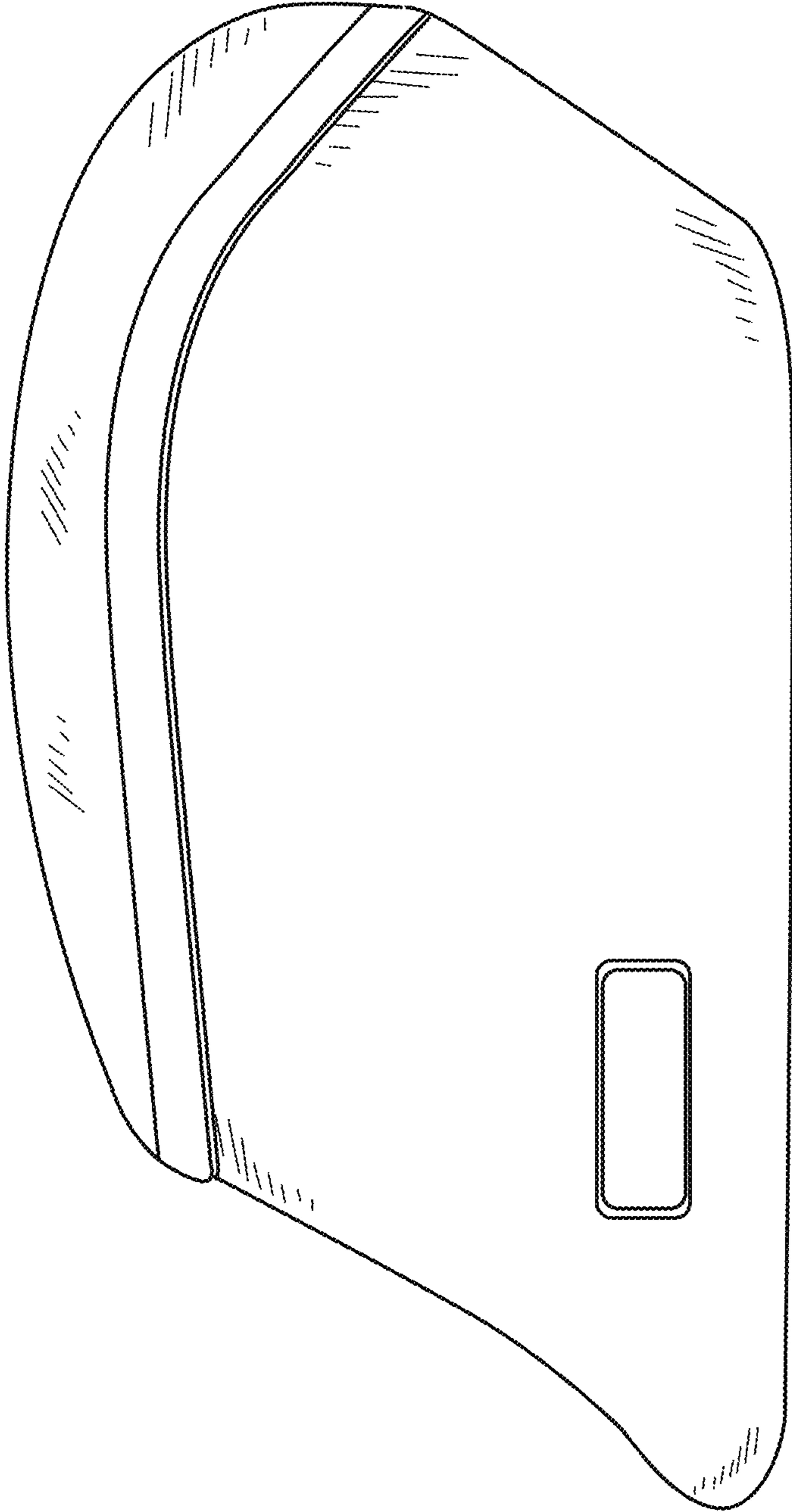

FIG. 7

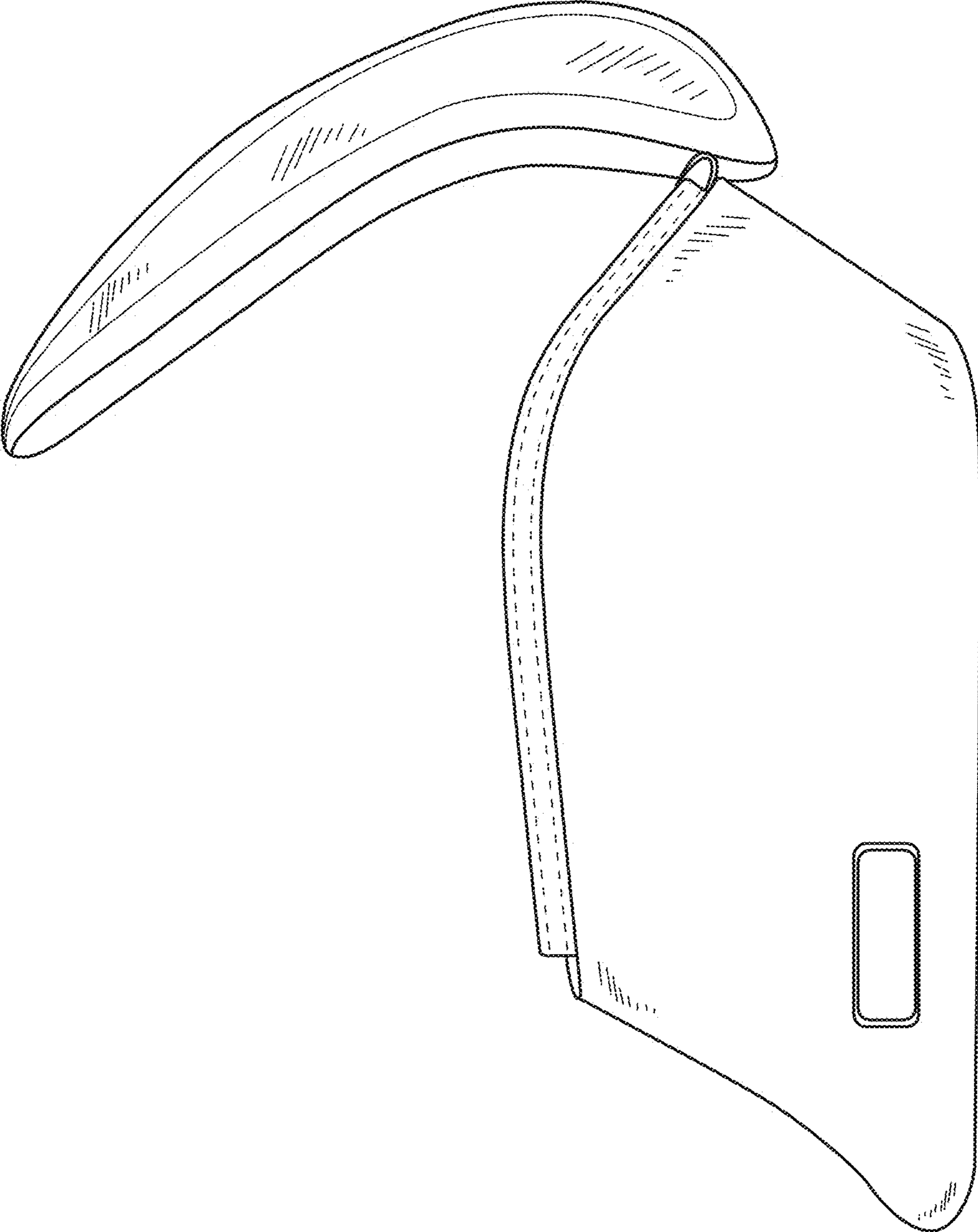

FIG. 8