



US00D806577S

(12) **United States Design Patent**
Nishi

(10) **Patent No.:** **US D806,577 S**
(45) **Date of Patent:** **** Jan. 2, 2018**

(54) **CLOCK**

(71) Applicant: **Rhythm Watch Co., Ltd.**, Saitama (JP)

(72) Inventor: **Kiyokazu Nishi**, Saitama (JP)

(73) Assignee: **Rhythm Watch Co., Ltd.**, Saitama (JP)

(**) Term: **15 Years**

(21) Appl. No.: **29/557,275**

(22) Filed: **Mar. 8, 2016**

(30) **Foreign Application Priority Data**

Dec. 28, 2015 (JP) 2015-029266

(51) **LOC (11) Cl.** **10-01**

(52) **U.S. Cl.**
USPC **D10/22; D10/124; D10/126**

(58) **Field of Classification Search**
USPC ... D10/1, 6, 7, 9, 15, 16, 17, 18, 21, 24, 25,
D10/27, 34, 39, 106.1, 123, 126, 128,
D10/129, 124, 122, 22

CPC G04G 13/026; G04G 10/00; G04G 9/04;
G04F 10/00; G04C 17/00; G04B 19/02
See application file for complete search history.

(56) **References Cited**

U.S. PATENT DOCUMENTS

- D3,780 S * 12/1868 Kroeber D10/2
- D44,557 S * 8/1913 Flauder D10/11
- D44,607 S * 9/1913 Flauder D10/11
- D46,390 S * 9/1914 Alexander D10/126
- D78,043 S * 3/1929 Streng D10/1
- D131,206 S * 1/1942 Hodge D10/124
- D158,602 S * 5/1950 Nelson D10/29
- D204,776 S * 5/1966 Appel D10/11
- 3,531,635 A * 9/1970 Hancock F21S 10/002
362/101
- D224,750 S * 9/1972 Daher D10/22

- D325,000 S * 3/1992 Tanaka D10/22
- D362,628 S * 9/1995 Yamatani D10/22
- D395,400 S * 6/1998 Sharp D10/29
- D407,023 S * 3/1999 Kuo D10/29

(Continued)

OTHER PUBLICATIONS

Gifts Online, Rhythm Clocks—Small World, no post date, [online], [site visited on Mar. 22, 2017]. Available from Internet, <URL: http://www.giftsonline.net/catalog/Rhythm_Musical_Clocks.html>.*

(Continued)

Primary Examiner — Sheryl Lane

Assistant Examiner — Samantha N Wood

(74) *Attorney, Agent, or Firm* — Kubotera & Associates, LLC

(57) **CLAIM**

The ornamental design for a clock, as shown and described.

DESCRIPTION

FIG. 1 is a front perspective view of a clock showing my new design;
 FIG. 2 is a front view thereof when a clock face is situated at an upper position;
 FIG. 3 is a rear view thereof;
 FIG. 4 is a left side view thereof;
 FIG. 5 is a right side view thereof;
 FIG. 6 is a top plan view thereof;
 FIG. 7 is a bottom view thereof; and
 FIG. 8 is a front view thereof when the clock face is moving downwardly;
 FIG. 9 is a front view thereof when the clock face is situated at a lower position; and,
 FIG. 10 is a perspective view thereof with a transparent front plate.
 Please note that the portions of the article shown in broken lines form no part of the claimed design.

1 Claim, 10 Drawing Sheets

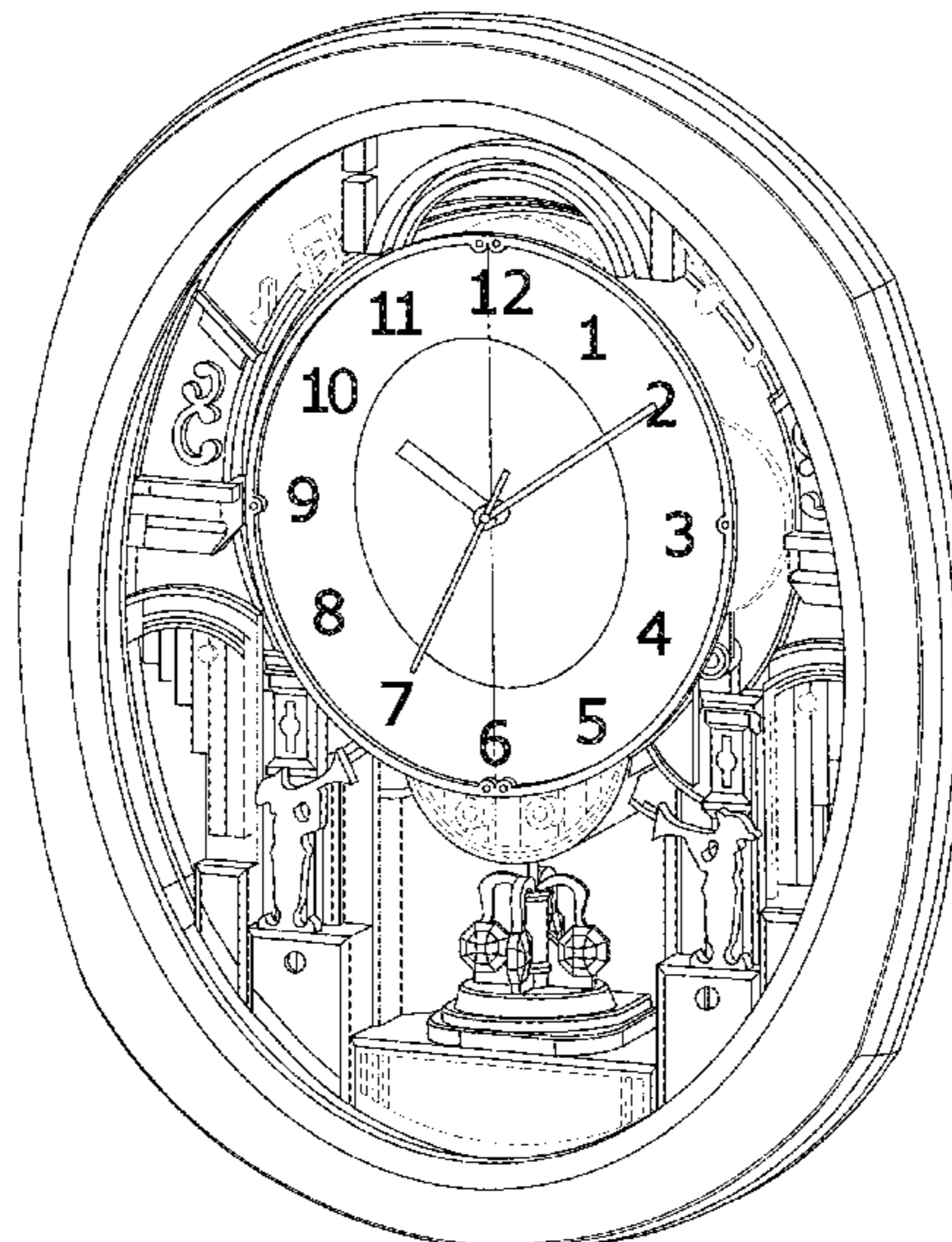

(56)

References Cited

U.S. PATENT DOCUMENTS

5,926,443 A * 7/1999 Kitaura G04B 41/005
 368/165
 6,229,768 B1 * 5/2001 Nakazawa G04B 19/065
 368/223
 7,339,855 B2 * 3/2008 Muraji G04B 19/16
 368/223
 7,480,213 B2 * 1/2009 Muraji G04B 19/16
 368/223
 D706,141 S * 6/2014 Kawase D10/22
 D706,646 S * 6/2014 Nishi D10/1
 D707,136 S * 6/2014 Nishi D10/1
 D724,957 S * 3/2015 Horiba D10/22
 D734,172 S * 7/2015 Nishi D10/124
 9,244,435 B2 * 1/2016 Tako G04B 45/0038
 2011/0019507 A1 * 1/2011 Muraji G04B 19/065
 368/220

OTHER PUBLICATIONS

Amazon, Enchanting Rhythm Musical Motion Clock, first available on Apr. 4, 2017, [online], [site visited on Mar. 22, 2017]. Available from Internet, <URL: https://www.amazon.co.uk/Enchanting-Rhythm-Musical-Swarovski-Elements/dp/B007RCFWXE/ref=sr_1_47?ie=UTF8&qid=1490197304&sr=8-47&keywords=rhythm+clock>.*

* cited by examiner

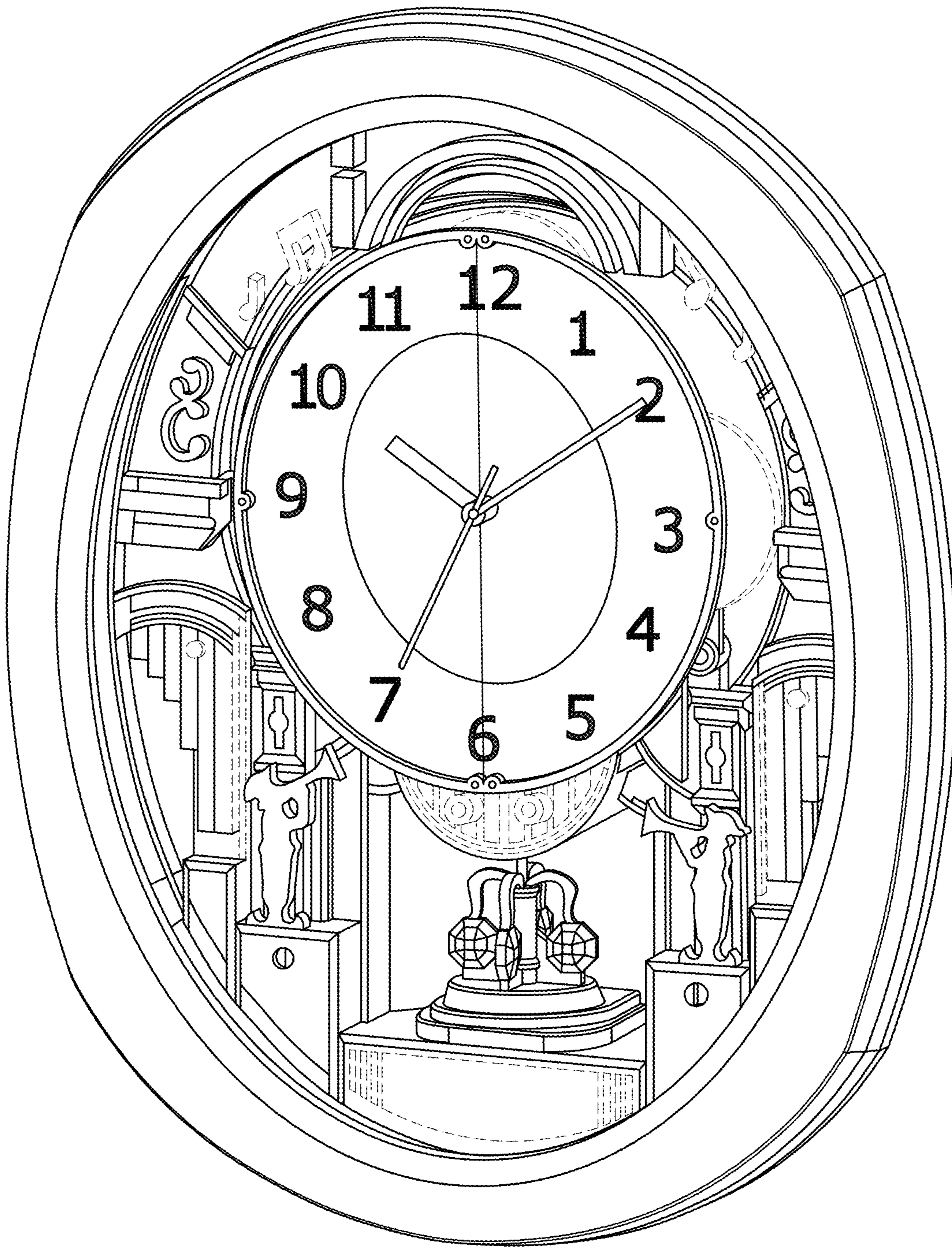

FIG. 1

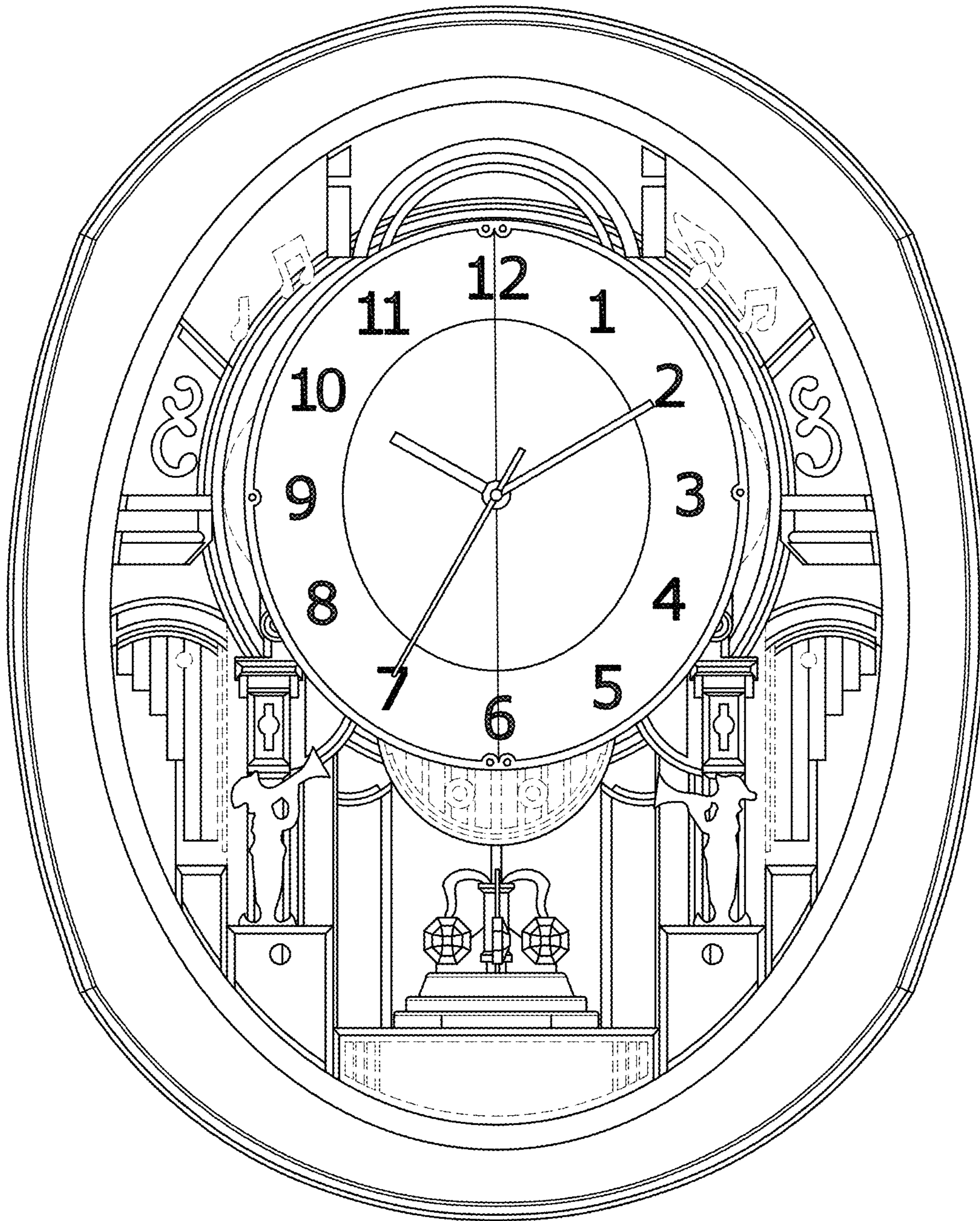

FIG. 2

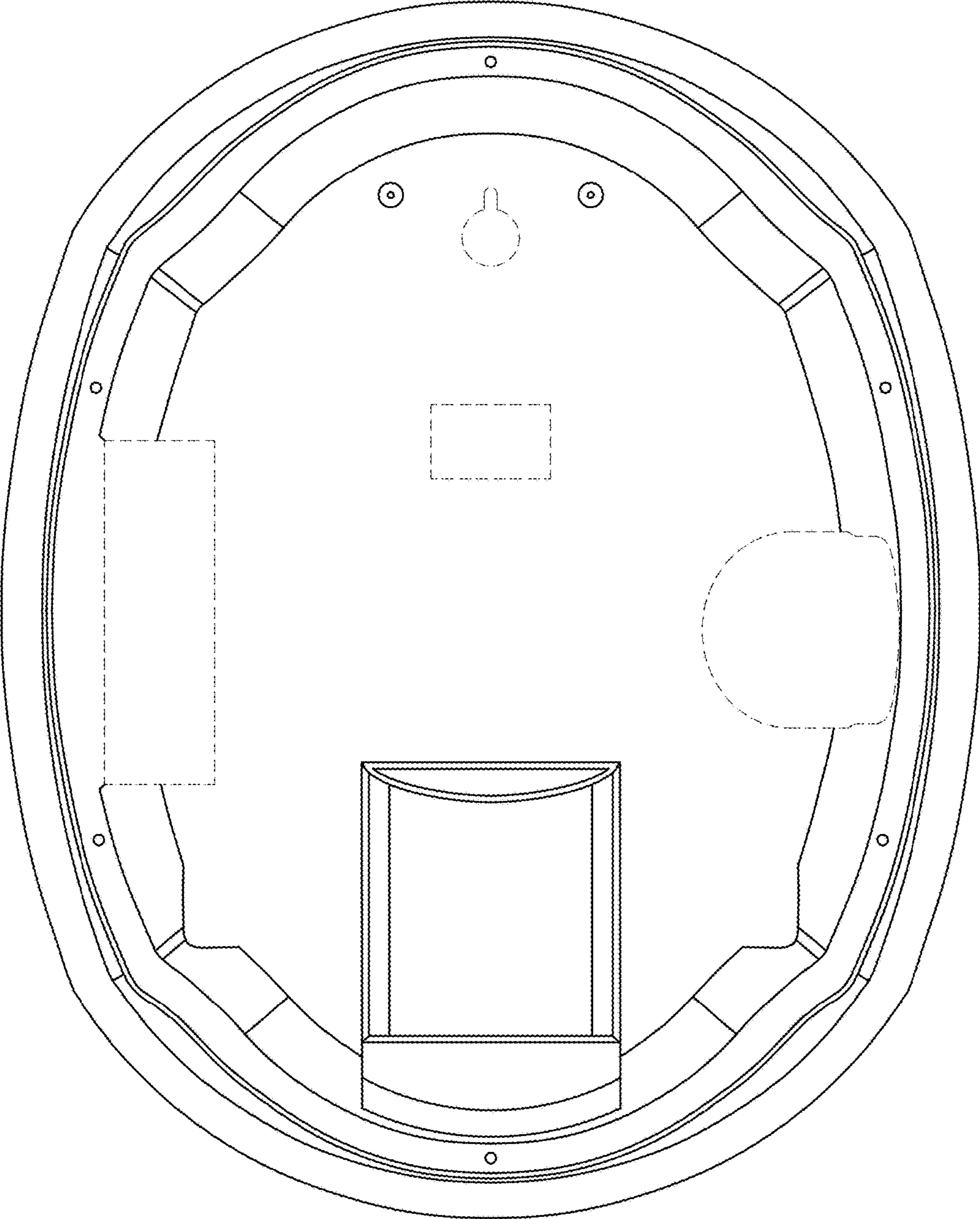

FIG. 3

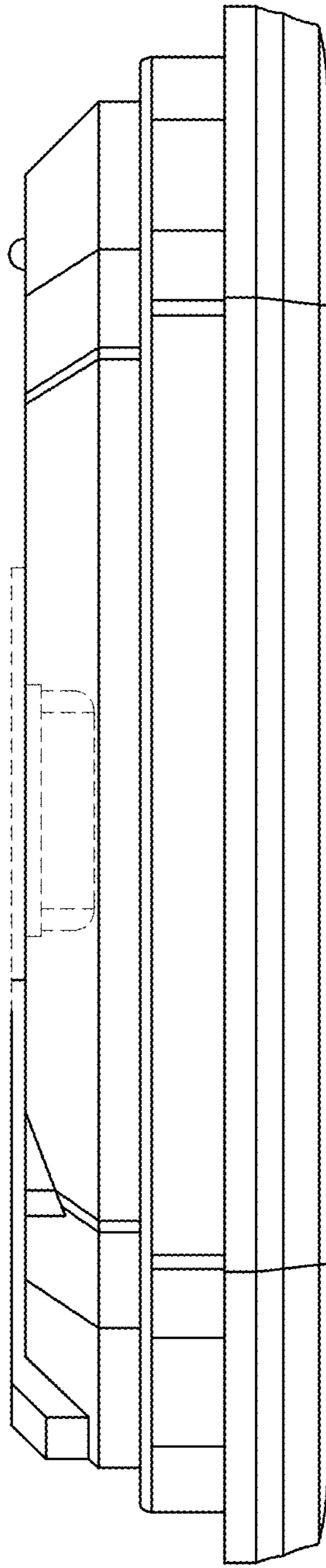

FIG. 4

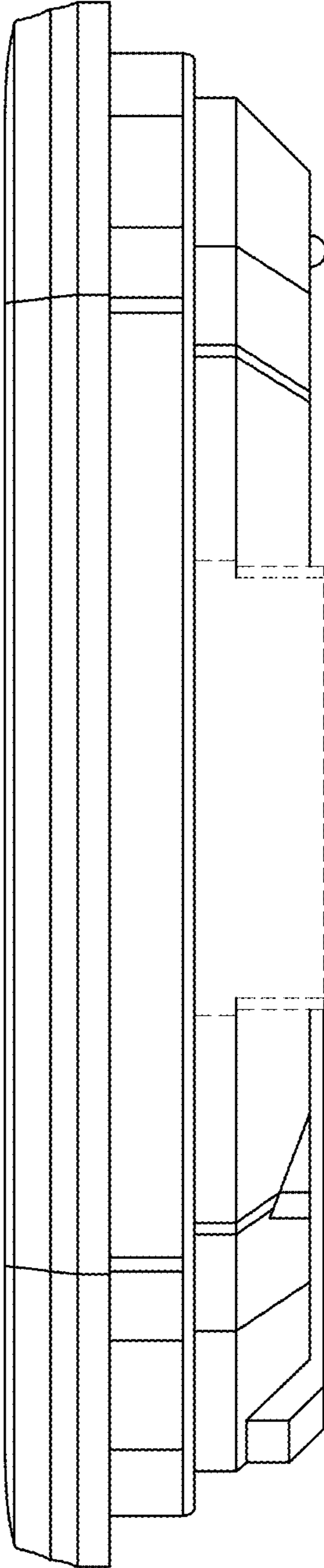

FIG. 5

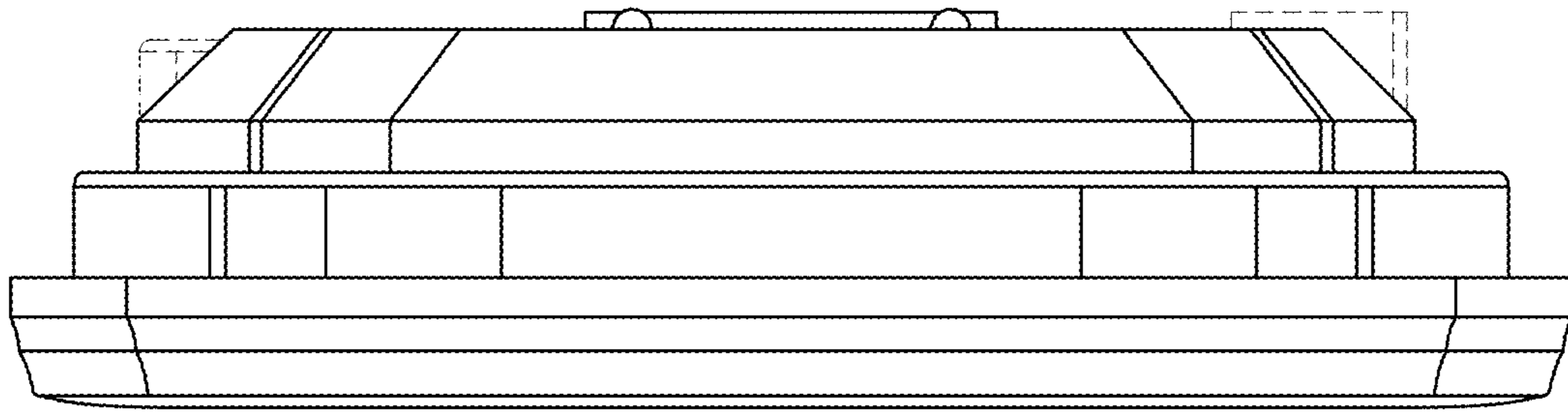

FIG.6

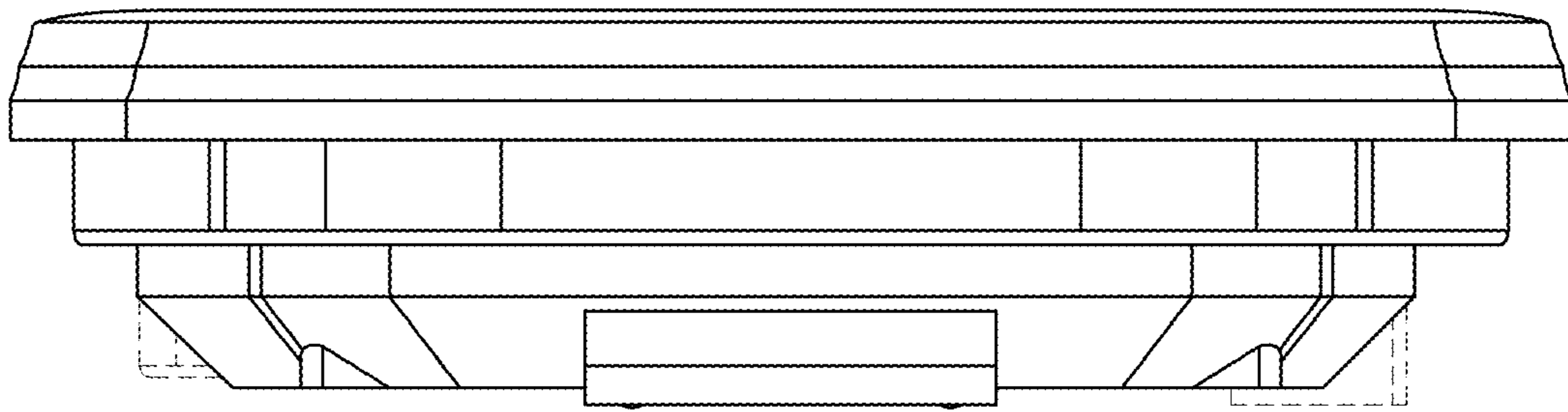

FIG.7

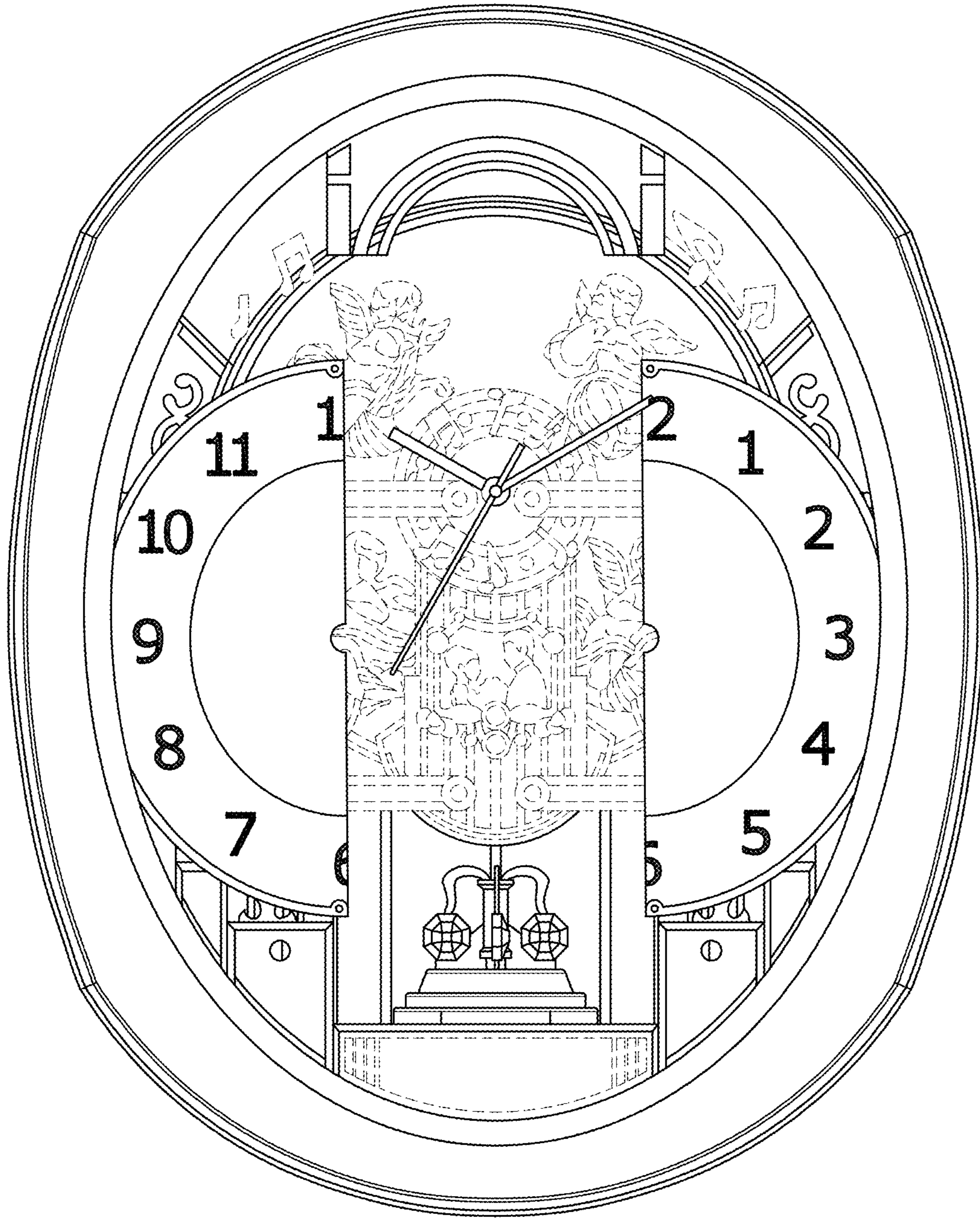

FIG. 8

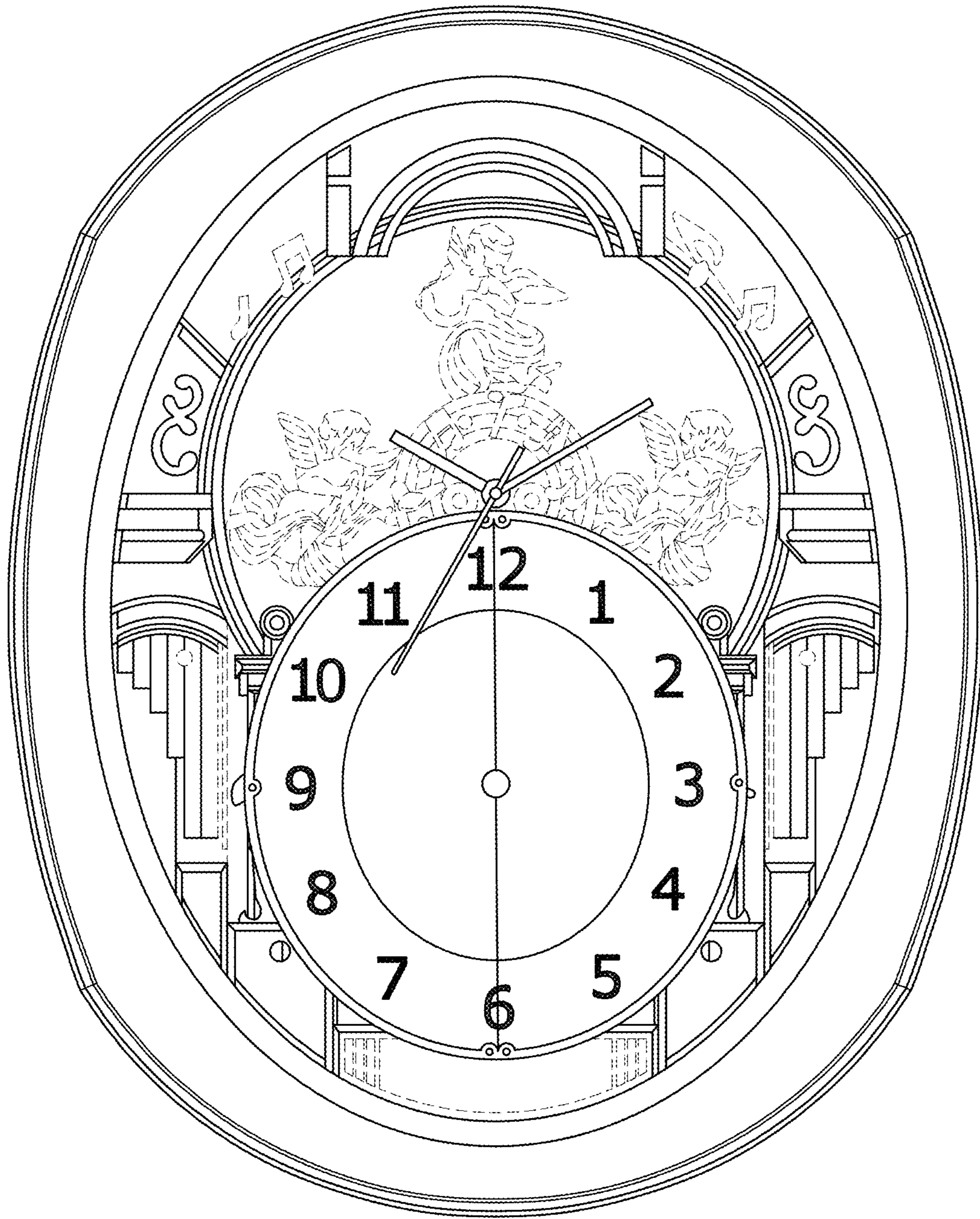

FIG. 9

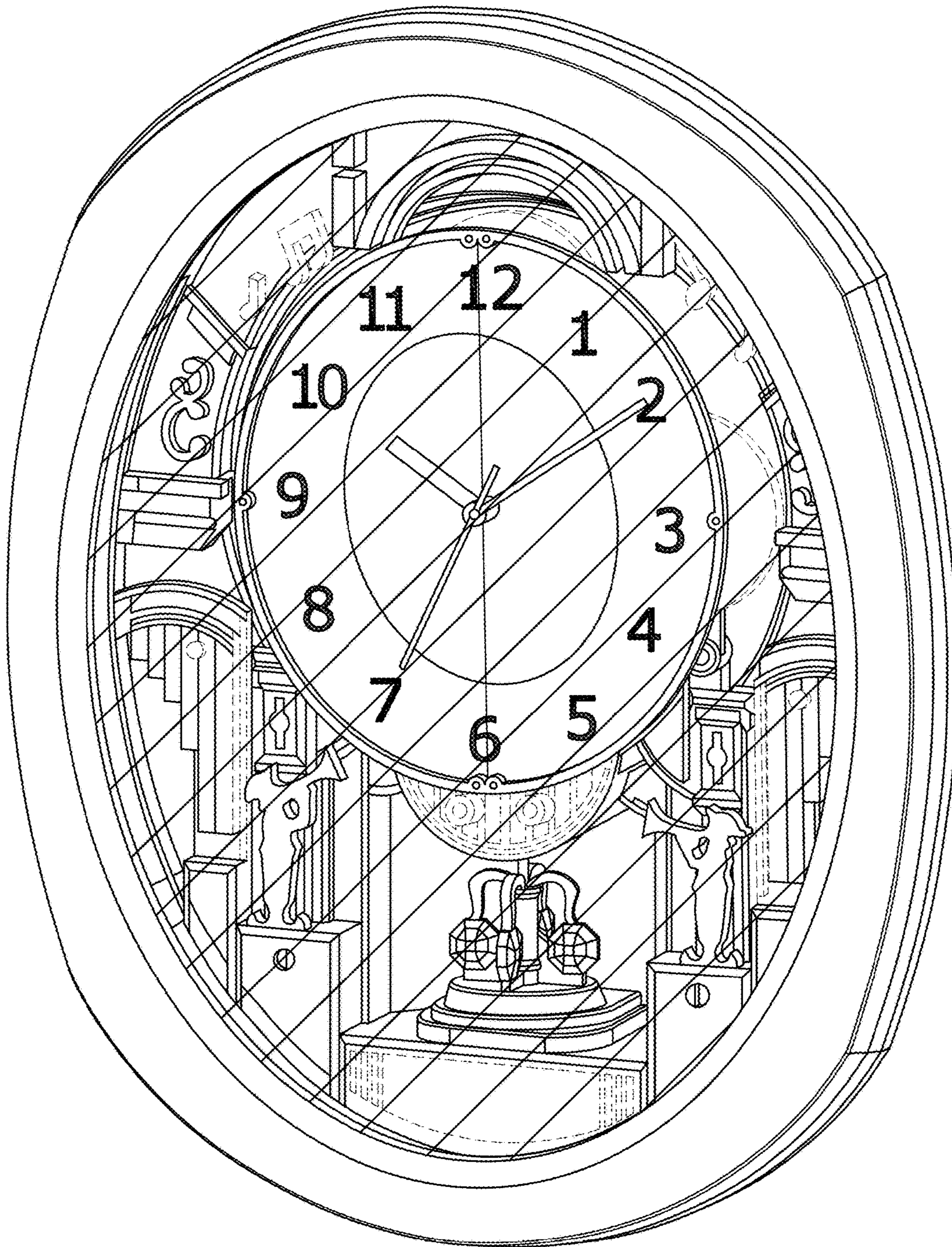

FIG. 10