



US00D806568S

(12) **United States Design Patent**  
**Chen et al.**

(10) **Patent No.:** **US D806,568 S**  
(45) **Date of Patent:** **\*\* Jan. 2, 2018**

(54) **WATER BOTTLE WITH DETACHABLE BRACELET**

(71) Applicant: **Ecomo Inc.**, Sunnyvale, CA (US)

(72) Inventors: **Tianyi Chen**, Mountain View, CA (US); **Zhiqiang Li**, Herndon, VA (US)

(\*\*) Term: **15 Years**

(21) Appl. No.: **29/576,566**

(22) Filed: **Sep. 5, 2016**

(51) **LOC (11) Cl.** ..... **09-01**

(52) **U.S. Cl.**  
USPC ..... **D9/719; D9/504; D7/507**

(58) **Field of Classification Search**  
USPC ..... D9/500, 504, 719, 738; D7/507, 510, D7/511; D3/202

CPC .... B65D 1/0223; B65D 51/18; B65D 1/0246; B65D 81/3205; B65D 41/0471; B65D 51/20; Y10T 428/1352; Y10T 428/13; Y10T 29/49826; B67D 3/0032; B67D 3/00; B67D 3/0029; B67D 3/0003; B67D 3/0041; B67D 3/0051

See application file for complete search history.

(56) **References Cited**

U.S. PATENT DOCUMENTS

D523,692 S *	6/2006	Meehan	.....	D7/507
D566,559 S *	4/2008	Swint	.....	D9/504
D628,088 S *	11/2010	Huntington	.....	D9/719
D635,457 S *	4/2011	Lane	.....	D7/510
D658,064 S *	4/2012	Barnes	.....	D9/532
D662,360 S *	6/2012	George	.....	D7/510
D675,100 S *	1/2013	Herbst	.....	D7/511
D708,954 S *	7/2014	Barnes	.....	D7/511
D728,315 S *	5/2015	Bo	.....	D7/511
D730,120 S *	5/2015	He	.....	D7/507
D752,391 S *	3/2016	Hatherell	.....	D7/510

D780,526 S *	3/2017	Liljedahl	.....	D7/608
2010/0236119 A1 *	9/2010	Pellei	.....	G09F 3/14 40/638
2013/0319915 A1 *	12/2013	Gellibolian	.....	C02F 1/002 210/87
2014/0372045 A1 *	12/2014	Keski-Pukkila	.....	A61B 5/6887 702/19

\* cited by examiner

*Primary Examiner* — Lauren Calve

(74) *Attorney, Agent, or Firm* — Chan Hubbard PLLC

(57) **CLAIM**

The ornamental design for a water bottle with detachable bracelet, as shown and described.

**DESCRIPTION**

FIG. 1 is a front right perspective view of a water bottle with detachable bracelet with the bracelet detached;  
 FIG. 2 is a front elevational view thereof;  
 FIG. 3 is a rear elevational view thereof;  
 FIG. 4 is a right side elevational view thereof, the left side elevational view being identical;  
 FIG. 5 is a top plan view thereof;  
 FIG. 6 is a bottom plan view thereof;  
 FIG. 7 is a front right perspective view of the water bottle with detachable bracelet with the bracelet attached;  
 FIG. 8 is a front elevational view thereof;  
 FIG. 9 is a rear elevational view thereof;  
 FIG. 10 is a right side elevational view thereof;  
 FIG. 11 is a left side elevational view thereof;  
 FIG. 12 is a top plan view thereof; and,  
 FIG. 13 is a bottom plan view thereof.

The shade lines in the figures represent contour and not surface ornamentation.

**1 Claim, 11 Drawing Sheets**

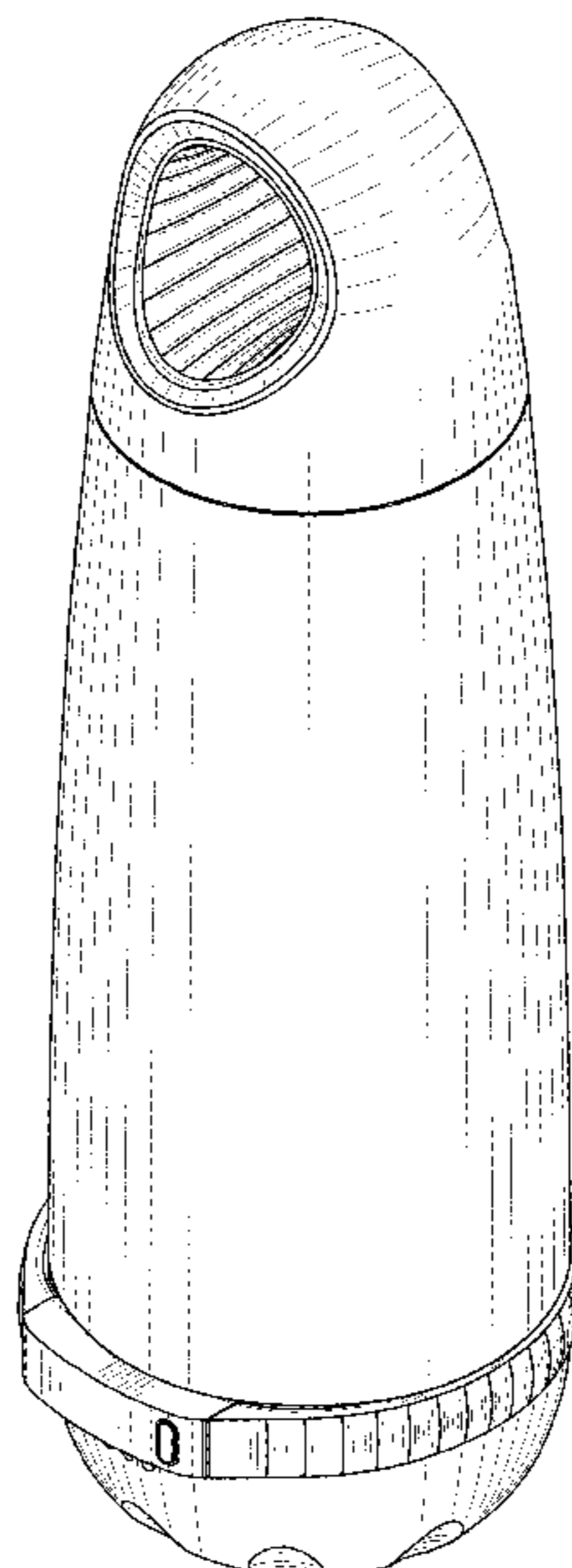

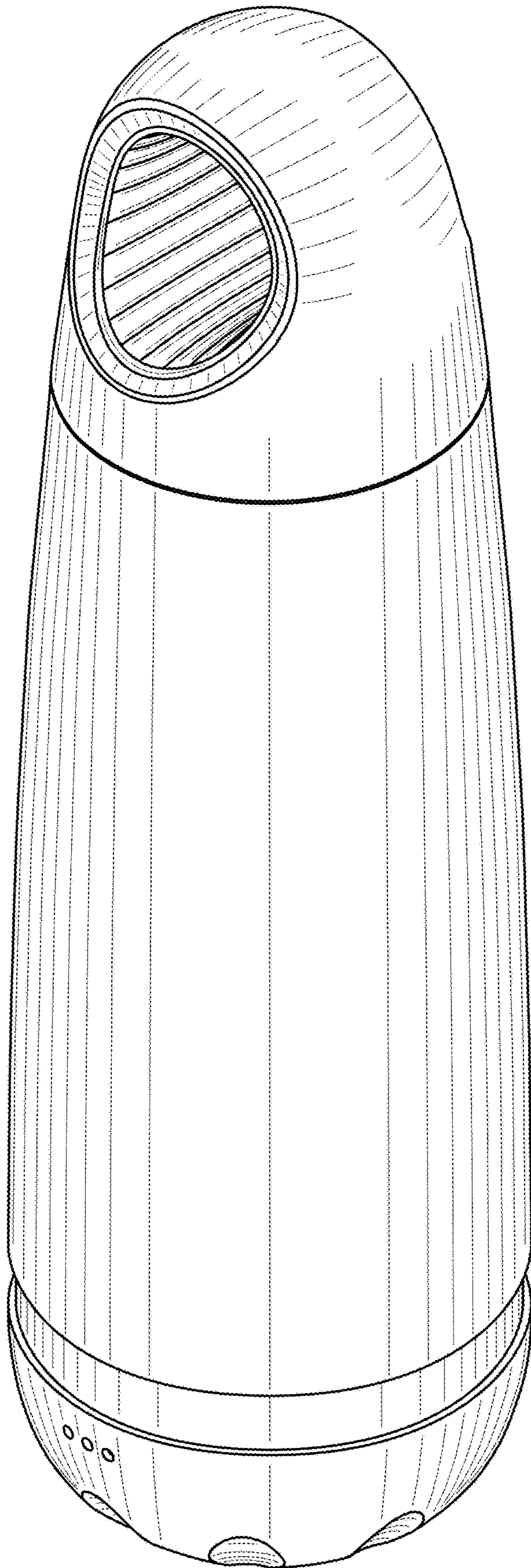

FIG. 1

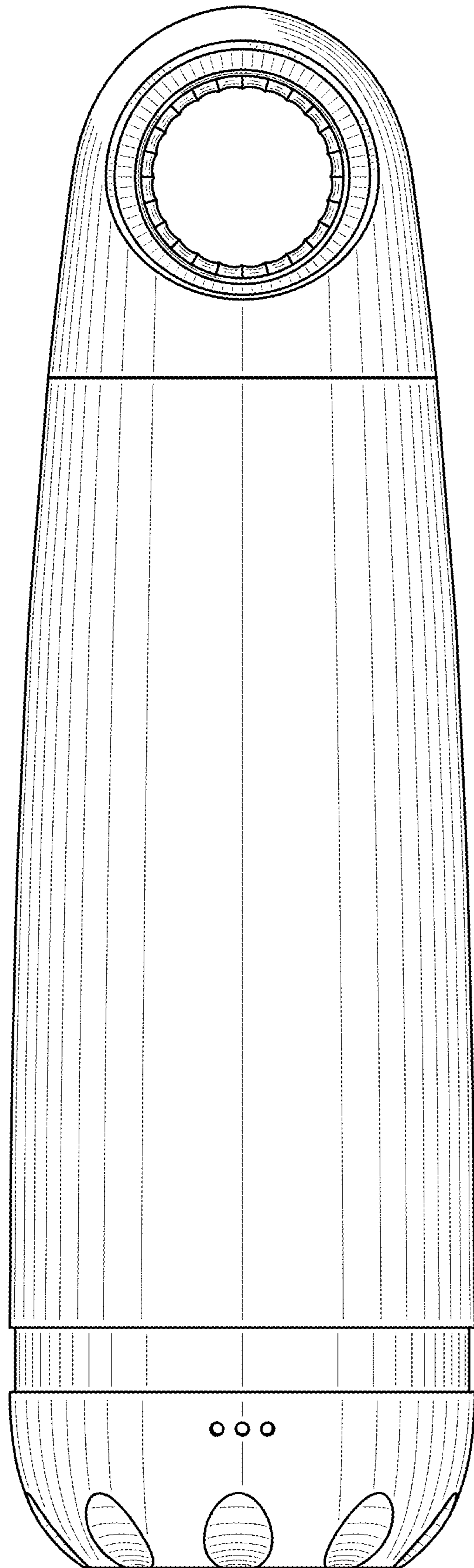

FIG. 2

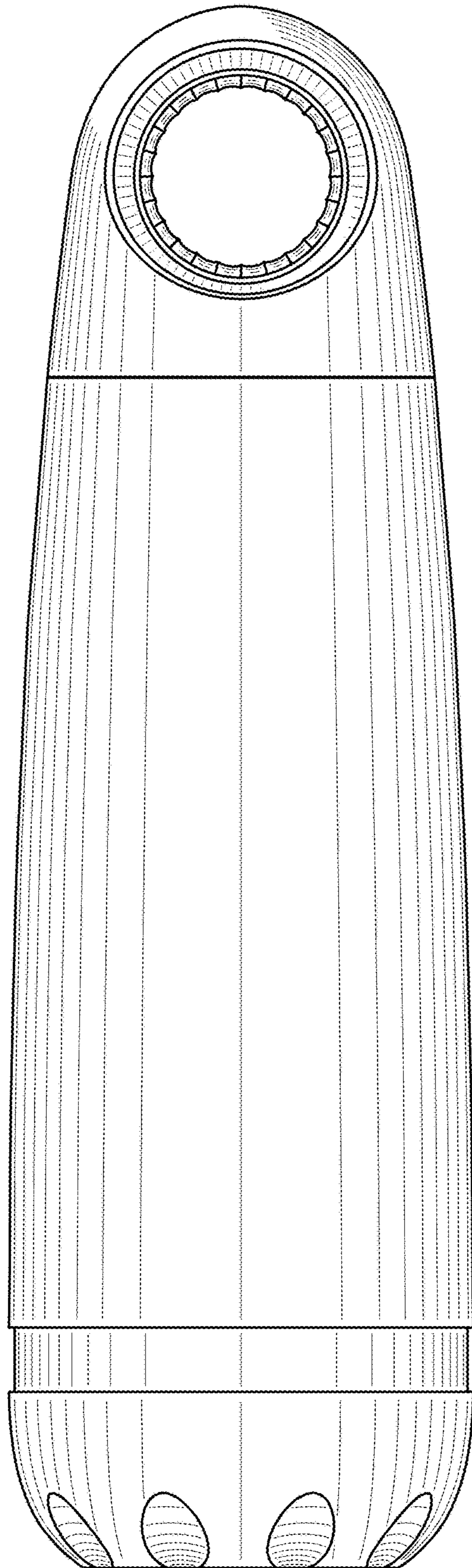

FIG. 3

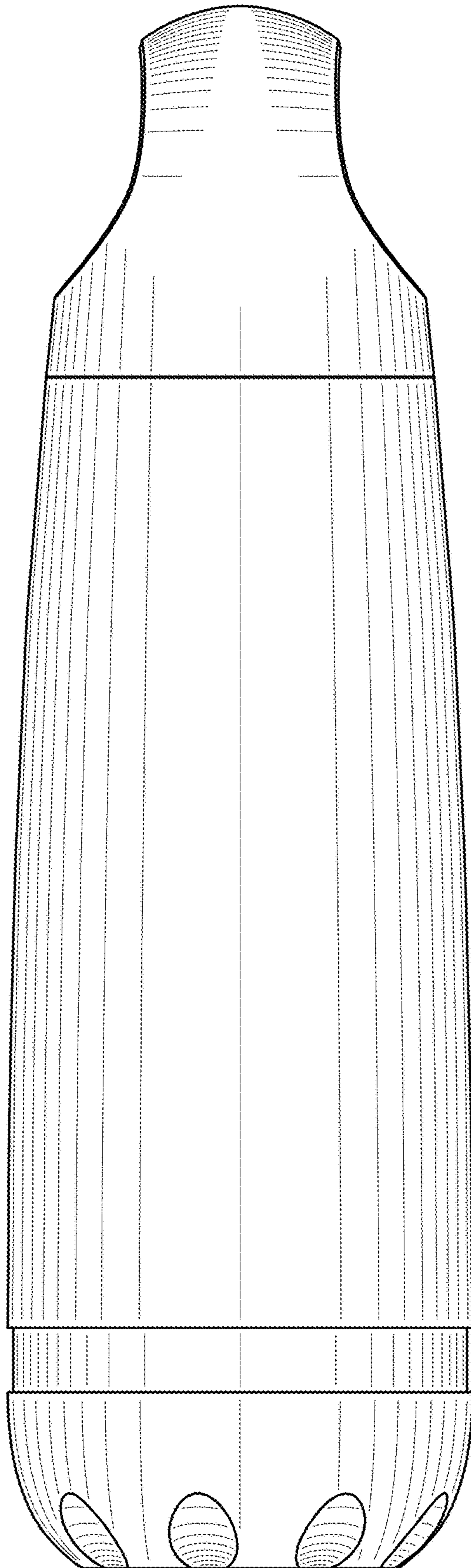

FIG. 4

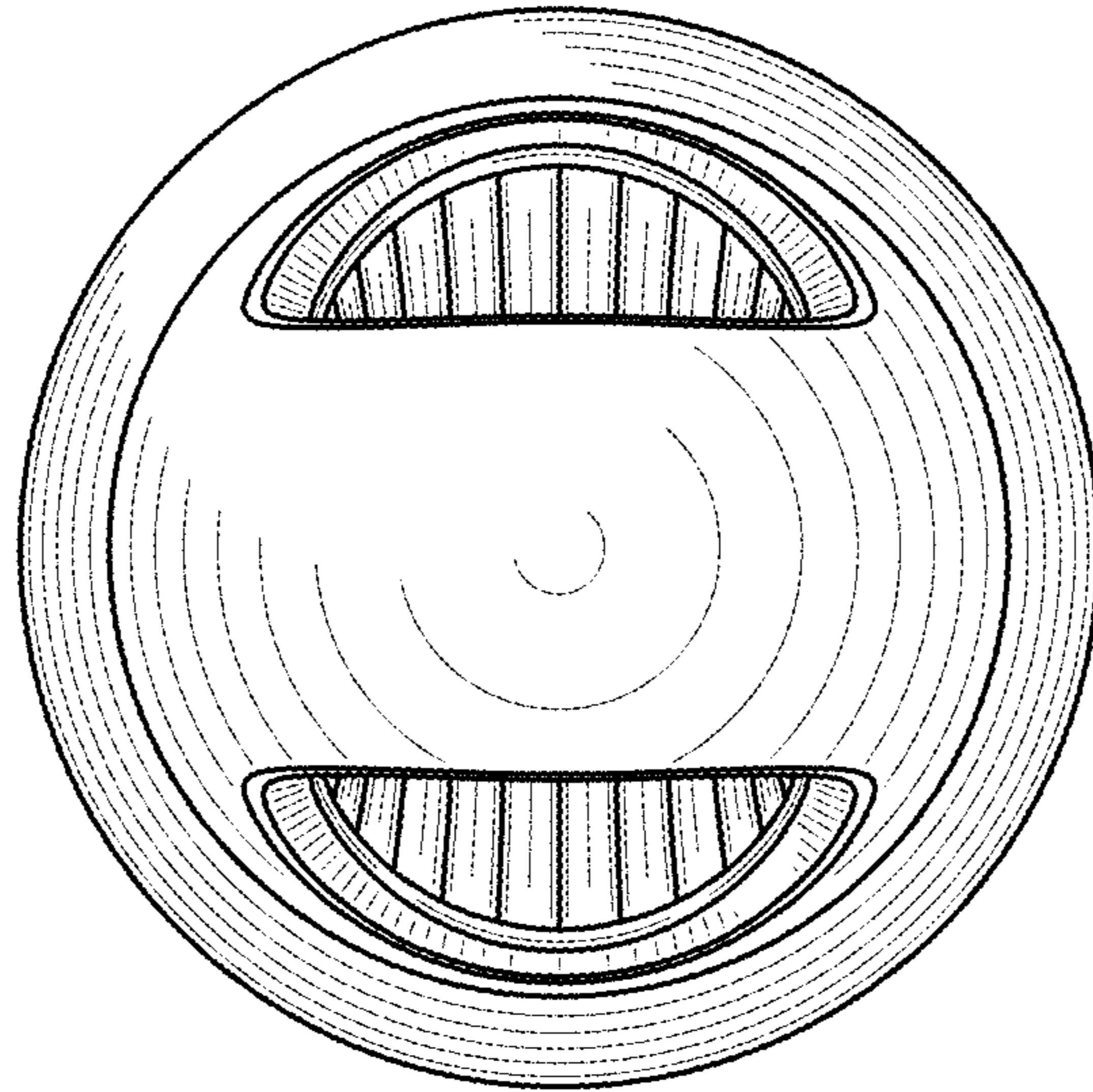

FIG. 5

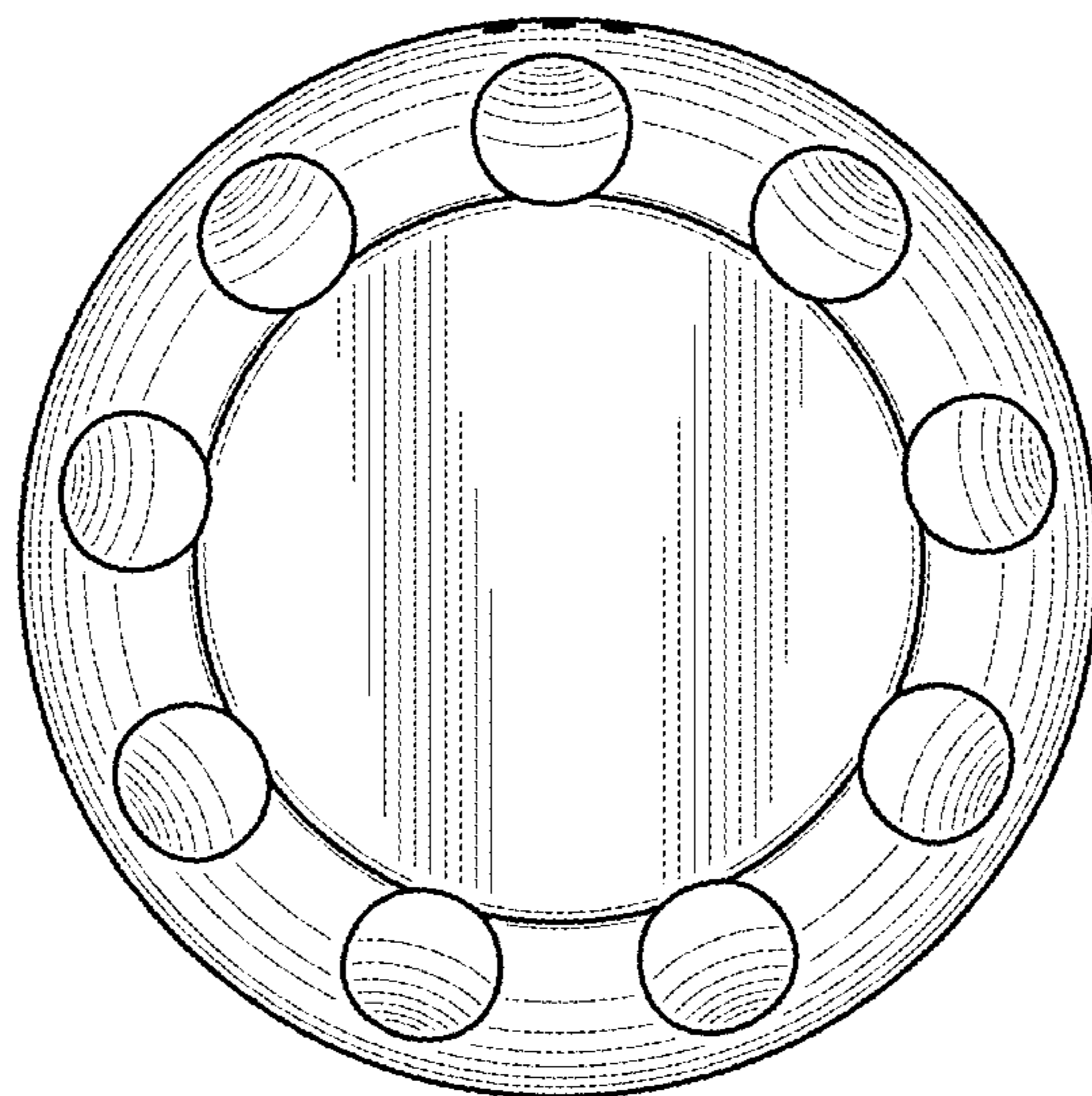

FIG. 6

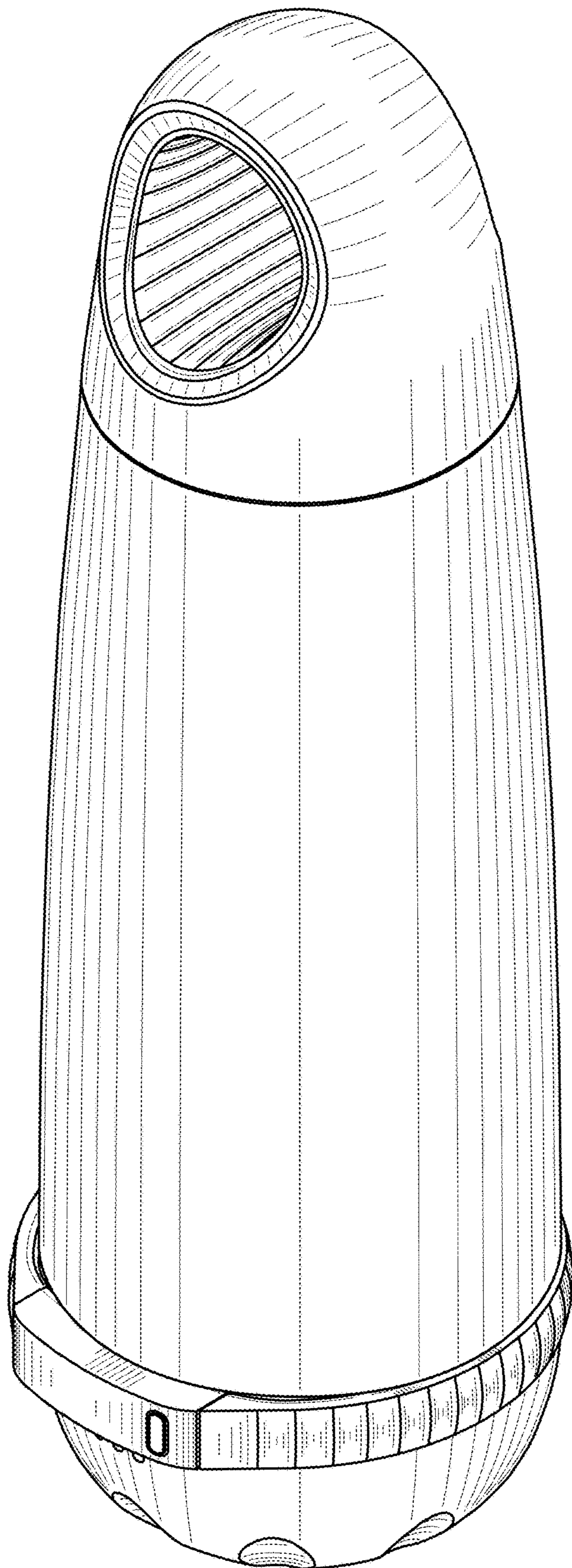

FIG. 7

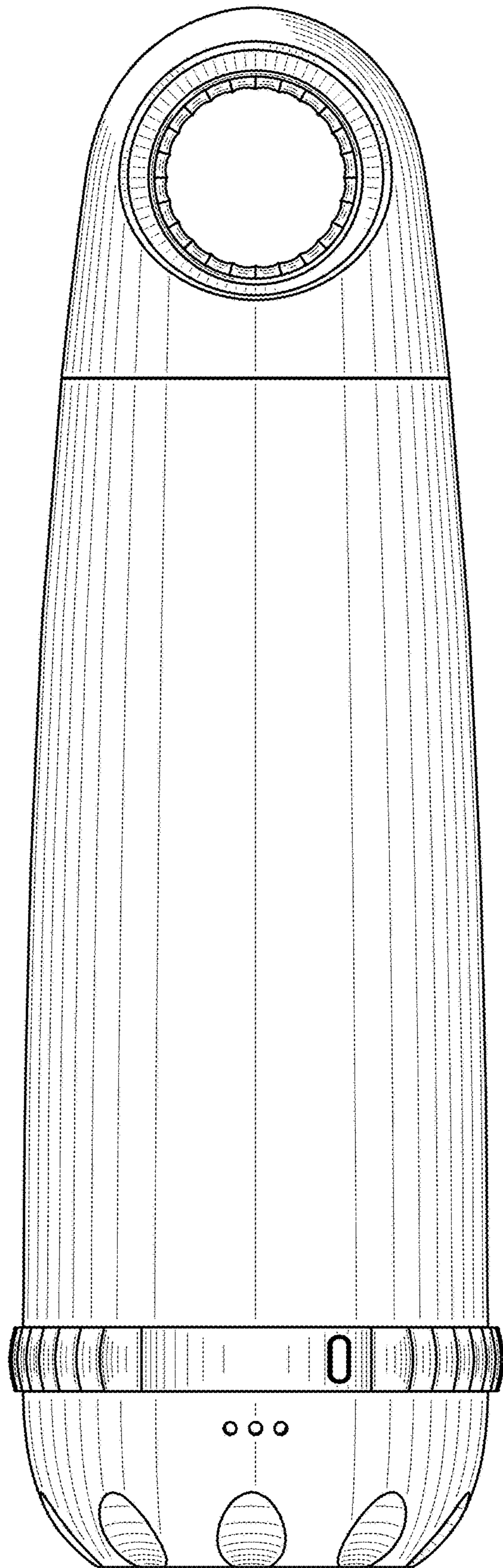

FIG. 8



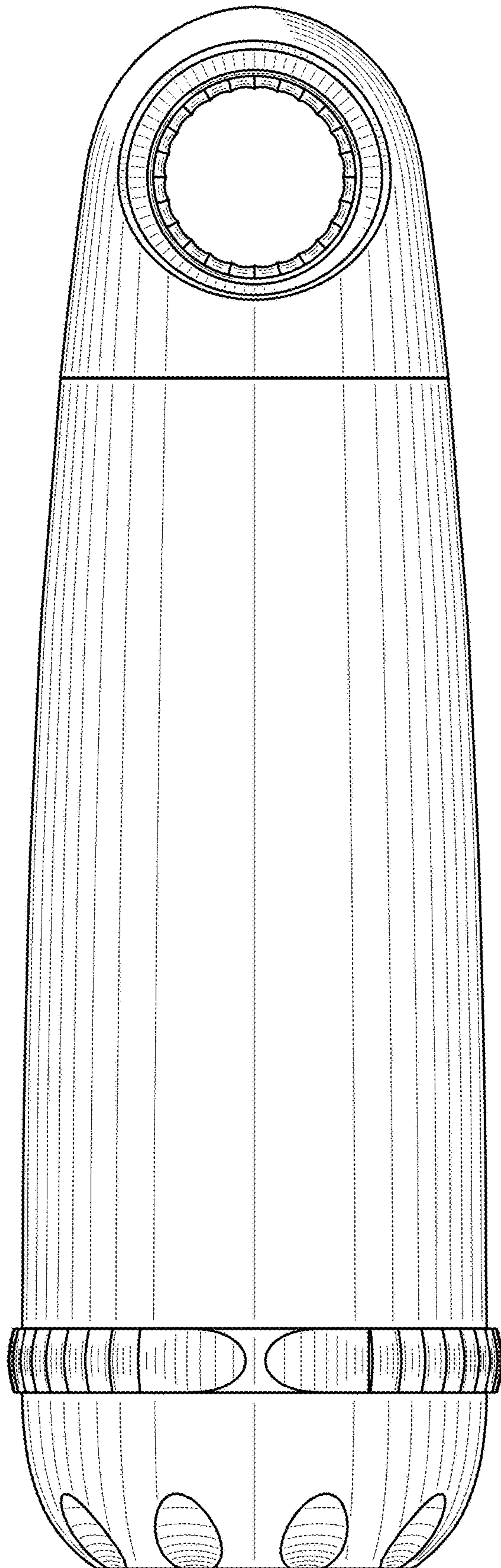

FIG. 9

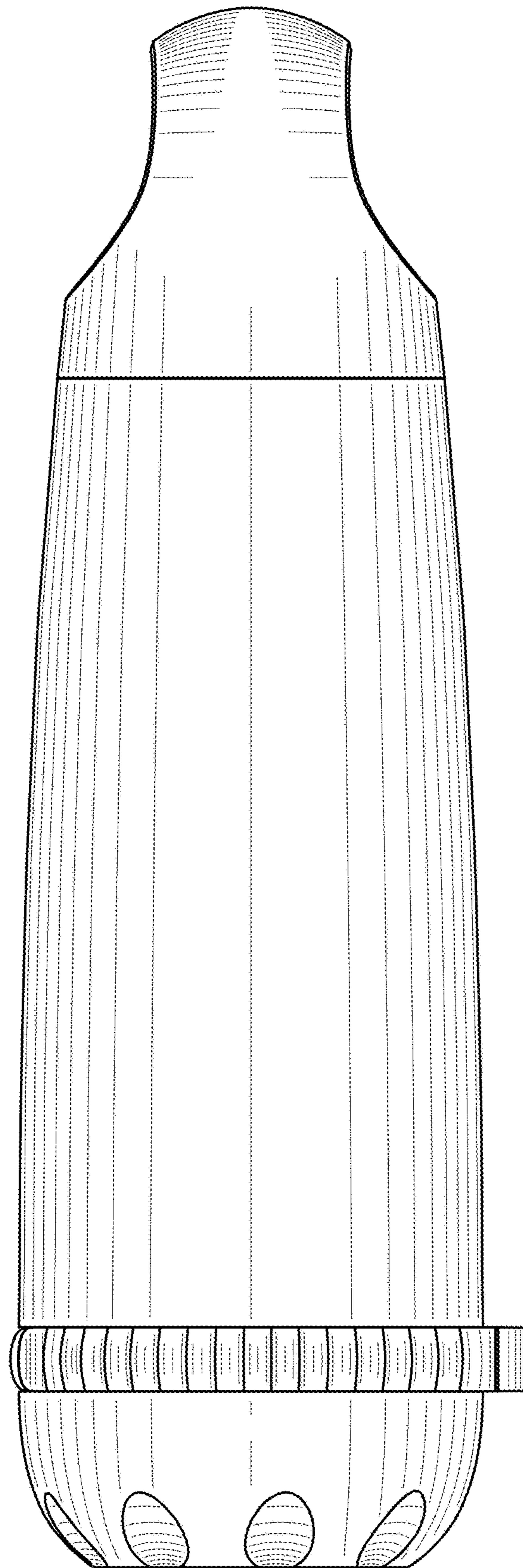

FIG. 10

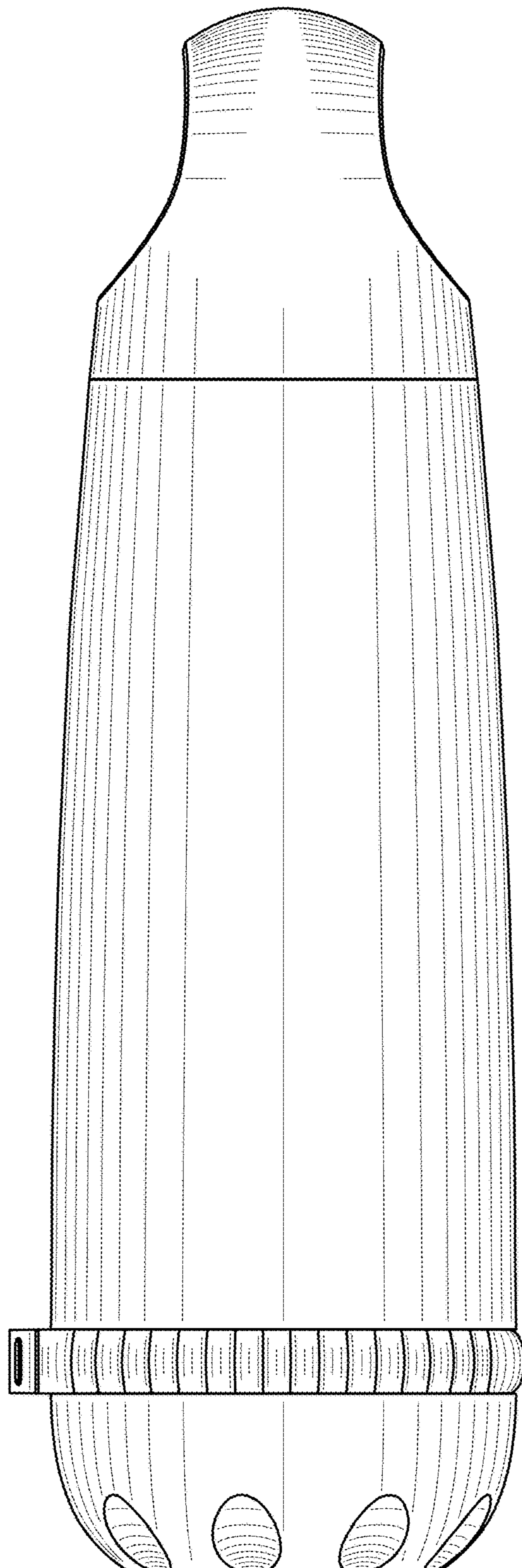

FIG. 11

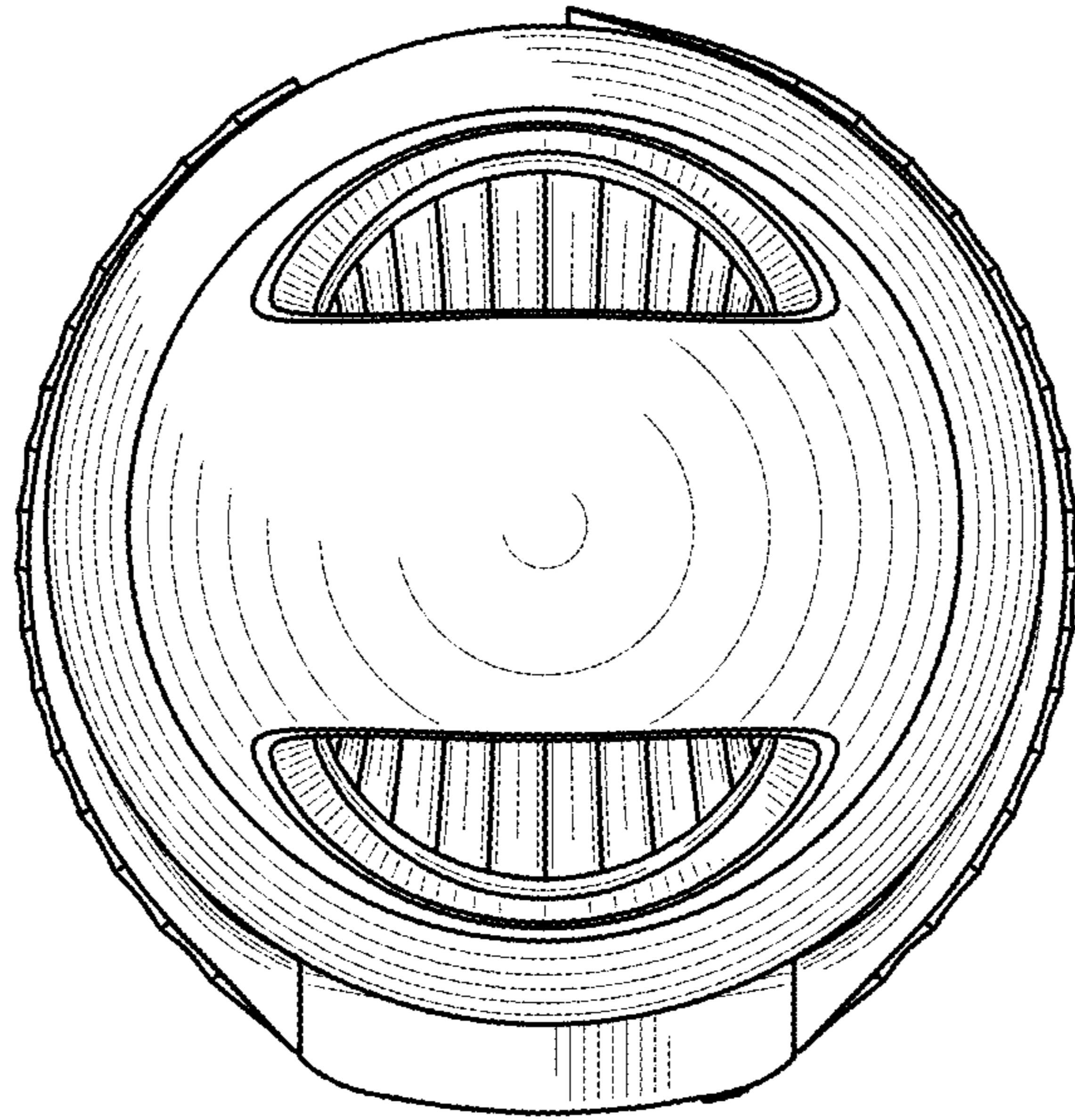

FIG. 12

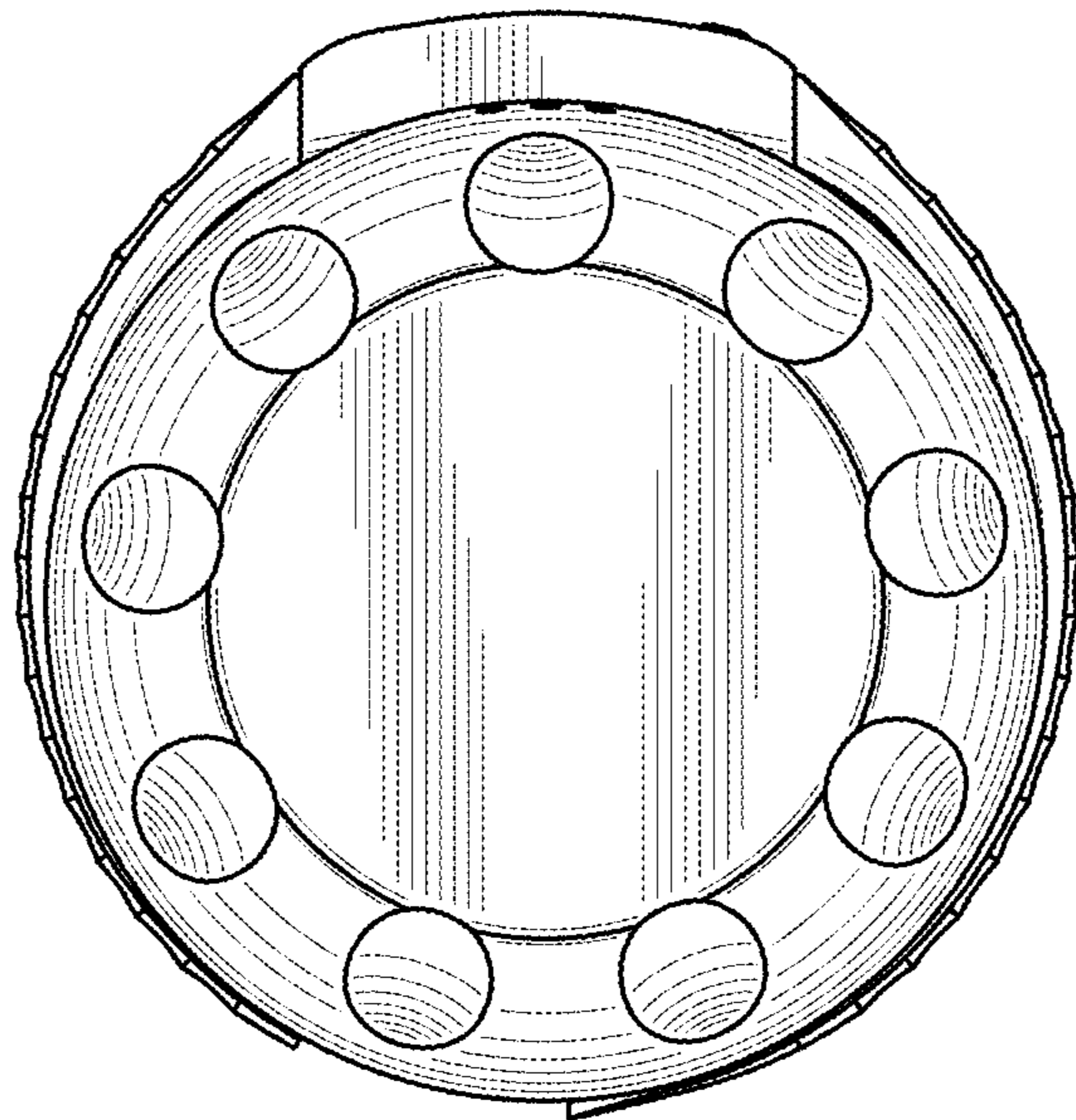

FIG. 13