



US00D806498S

(12) **United States Design Patent** (10) **Patent No.:** **US D806,498 S**  
**Bloch** (45) **Date of Patent:** **\*\* Jan. 2, 2018**

(54) **KNIFE**  
(71) Applicant: **Outdoor Edge Cutlery Corporation,**  
Denver, CO (US)  
(72) Inventor: **David R. Bloch,** Morrison, CO (US)  
(73) Assignee: **OUTDOOR EDGE CUTLERY**  
**CORPORATION,** Denver, CO (US)  
(\*\*) Term: **15 Years**  
(21) Appl. No.: **29/566,349**  
(22) Filed: **May 27, 2016**  
(51) **LOC (11) Cl.** ..... **08-03**  
(52) **U.S. Cl.**  
USPC ..... **D8/99**  
(58) **Field of Classification Search**  
USPC ..... D8/98, 99, 100, 105, 107; D22/118  
CPC .... B26B 1/00; B26B 1/02; B26B 1/04; B26B  
1/042; B26B 1/044; B26B 1/10  
See application file for complete search history.

D377,744 S \* 2/1997 Hasegawa ..... D8/99  
D383,370 S 9/1997 Chen et al.  
D385,173 S \* 10/1997 McWillis ..... D8/99  
D385,471 S 10/1997 Seber et al.  
5,689,889 A 11/1997 Overholt  
D392,539 S 3/1998 Balolia  
D393,405 S 4/1998 Seber et al.  
6,058,611 A 5/2000 Rickard  
D442,461 S 5/2001 Glesser  
6,263,581 B1 7/2001 Forte  
(Continued)

FOREIGN PATENT DOCUMENTS

AU 2006202953 8/2006  
CA 2481333 6/2005  
(Continued)

OTHER PUBLICATIONS

Image of Outdoor edge Field lite knife. Circa 2001.\*  
(Continued)

*Primary Examiner* — Phillip S Hyder  
(74) *Attorney, Agent, or Firm* — Lewis Brisbois Bisgaard  
& Smith LLP; Craig Mueller

(56) **References Cited**  
U.S. PATENT DOCUMENTS

1,738,365 A 12/1929 Gahagan  
D100,877 S 8/1936 Parker et al.  
D172,377 S 6/1954 Woofter  
3,488,843 A 1/1970 Tims, Jr.  
3,772,955 A 11/1973 Pearl  
3,896,546 A 7/1975 Hildebrandt  
4,161,818 A 7/1979 Phelps  
4,173,071 A 11/1979 Ishida  
D265,719 S 8/1982 Dowdy  
D277,452 S 2/1985 Ulvtorp  
D333,251 S 2/1993 Glesser  
D347,375 S \* 5/1994 Sakai ..... D22/118  
5,495,673 A \* 3/1996 Gardiner ..... B26B 11/00  
30/155  
5,511,310 A 4/1996 Sessions et al.  
D371,288 S 7/1996 Thompson

(57) **CLAIM**  
The ornamental design for a knife, as shown and described.

**DESCRIPTION**

FIG. 1 is a perspective view of the knife, showing my new design;  
FIG. 2 is a front elevation view thereof;  
FIG. 3 is a rear elevation view thereof;  
FIG. 4 is a right elevation view thereof;  
FIG. 5 is a left elevation view thereof;  
FIG. 6 is a top plan view thereof; and,  
FIG. 7 is a bottom plan view thereof.

**1 Claim, 4 Drawing Sheets**

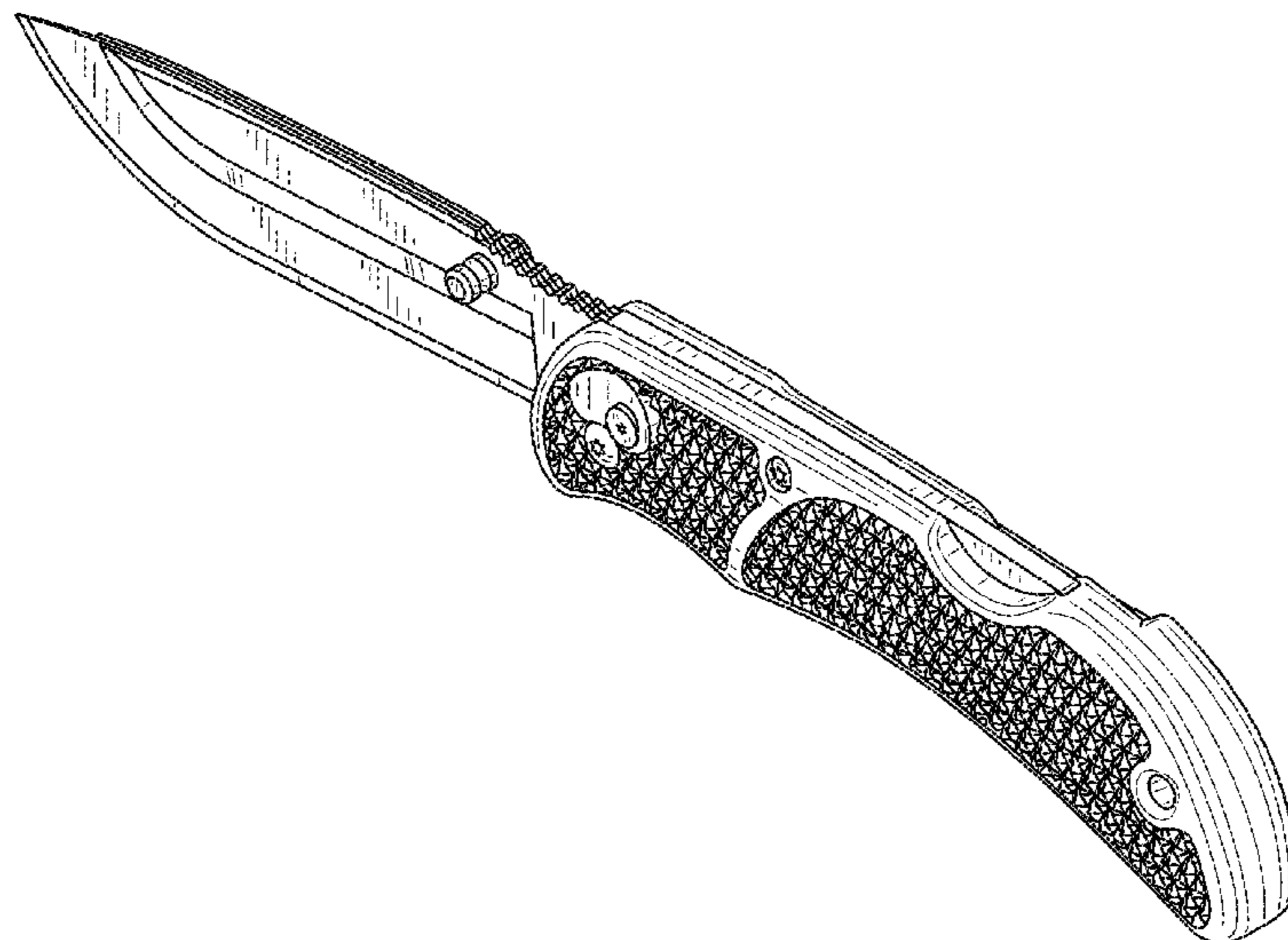

(56)

References Cited

U.S. PATENT DOCUMENTS

6,397,476	B1	6/2002	Onion
6,446,341	B1	9/2002	Wang et al.
6,574,868	B1	6/2003	Overholt
D501,782	S	2/2005	Ping
D510,250	S	10/2005	Ping
D516,403	S	3/2006	Ping
D517,893	S	3/2006	Ping
D519,019	S	4/2006	Ping
D522,835	S	6/2006	Ping
D526,878	S	8/2006	Ping
D528,894	S	9/2006	Ping
D528,895	S	9/2006	Ping
7,134,207	B2	11/2006	Ping
7,172,611	B2	2/2007	Harding et al.
D543,822	S	6/2007	Ping
D545,165	S	6/2007	Ping
D546,158	S	7/2007	Ping
D552,955	S	10/2007	Ping
D562,651	S	2/2008	Harkey
D564,326	S	3/2008	Tsuda et al.
D567,055	S	4/2008	Renzi et al.
D568,136	S	5/2008	Ping
D573,435	S	7/2008	Tsuda et al.
D574,691	S	8/2008	Ping
D578,858	S	10/2008	Ping
D579,299	S	10/2008	Ping
D583,643	S	12/2008	Ping
D584,125	S	1/2009	Ping
7,480,997	B2	1/2009	Ping
D592,033	S	5/2009	Bloch
D593,838	S	6/2009	Williams
7,900,363	B1	3/2011	White
D654,144	S	2/2012	Karlsson et al.
8,381,407	B1	2/2013	White
8,935,855	B2	1/2015	Qiu
D728,339	S	5/2015	Bloch
D738,181	S	9/2015	Kanaan
D747,637	S	1/2016	Bloch
D751,882	S	3/2016	Bloch
D764,888	S	8/2016	Bloch
9,586,329	B2 *	3/2017	Schuft ..... B26B 5/001
2004/0226173	A1	11/2004	Ping
2004/0231169	A1	11/2004	Roberson
2005/0138816	A1	6/2005	Ping
2005/0229404	A1	10/2005	Nordqvist et al.
2006/0064877	A1	3/2006	Vallotton et al.
2007/0006466	A1	1/2007	Ping
2007/0294895	A1	12/2007	Ping
2008/0148576	A1	6/2008	Ping
2010/0175267	A1	7/2010	Seber et al.
2010/0299935	A1	12/2010	Ping
2011/0023308	A1	2/2011	Ping
2012/0030949	A1	2/2012	Ping
2012/0227267	A1	9/2012	Qiu
2013/0227794	A1	9/2013	Wang
2013/0255087	A1	10/2013	Wang
2014/0115851	A1	5/2014	Bloch et al.
2014/0216605	A1	8/2014	Batty
2016/0271809	A1	9/2016	Bloch

FOREIGN PATENT DOCUMENTS

CN	201677334	12/2010
CN	102756384	10/2012

CN	102990680	3/2013
CN	102990681	3/2013
EP	1570959	9/2005
FR	2848138	6/2004
FR	2864463	7/2005
FR	2867716	9/2005
FR	2870152	11/2005
WO	WO 2014/000347	1/2014
WO	WO 2014/082447	6/2014

OTHER PUBLICATIONS

Notice of Allowance for U.S. Appl. No. 14/063,333, dated Mar. 2, 2017, 9 pages.

Notice of Allowance for U.S. Appl. No. 29/551,898, dated Apr. 11, 2017, 8 pages.

Notice of Allowance for Canadian Patent Application No. 2,889,292, dated Nov. 29, 2016, 1 page.

Official Action for European Patent Application No. 13848616.2, dated Dec. 2, 2016, 3 pages.

U.S. Appl. No. 29/551,796, filed Jan. 15, 2016, Bloch.

U.S. Appl. No. 29/551,898, filed Jan. 18, 2016, Bloch.

U.S. Appl. No. 29/570,656, filed Jul. 11, 2016, Bloch et al.

U.S. Appl. No. 29/575,909, filed Aug. 30, 2016, Bloch.

International Search Report and Written Opinion for International (PCT) Patent Application No. PCT/US2013/066877 dated Mar. 18, 2014, 8 pages.

International Preliminary Report on Patentability for International (PCT) Patent Application No. PCT/US2013/066377 dated May 7, 2015, 7 pages.

Official Action for Canadian Patent Application No. 2,889,292, dated Mar. 1, 2016, 6 pages.

Extended European Search Report for European Patent Application No. 13848616.2, dated Jun. 14, 2016, 5 pages.

Official Action for U.S. Appl. No. 14/063,333, dated Sep. 11, 2015, 6 pages Restriction Requirement.

Official Action for U.S. Appl. No. 14/063,333, dated Nov. 9, 2015, 13 pages.

Final Action for U.S. Appl. No. 14/063,333, dated May 20, 2016, 16 pages.

Official Action for U.S. Appl. No. 14/063,333, dated Aug. 25, 2016, 21 pages.

Official Action for U.S. Appl. No. 29/440,686, dated Mar. 14, 2014, 6 pages.

Official Action for U.S. Appl. No. 29/440,686, dated Oct. 27, 2014, 8 pages.

Notice of Allowance for U.S. Appl. No. 29/440,686, dated Jan. 5, 2015, 7 pages.

Official Action for U.S. Appl. No. 29/475,511, dated Apr. 27, 2015, 6 pages Restriction Requirement.

Official Action for U.S. Appl. No. 29/475,511, dated Jun. 5, 2015, 7 pages.

Notice of Allowance for U.S. Appl. No. 29/475,511, dated Nov. 9, 2015, 7 pages.

Notice of Allowance for U.S. Appl. No. 29/507,929, dated Nov. 16, 2015, 9 pages.

Notice of Allowance for U.S. Appl. No. 29/515,058, dated May 11, 2016, 8 pages.

\* cited by examiner

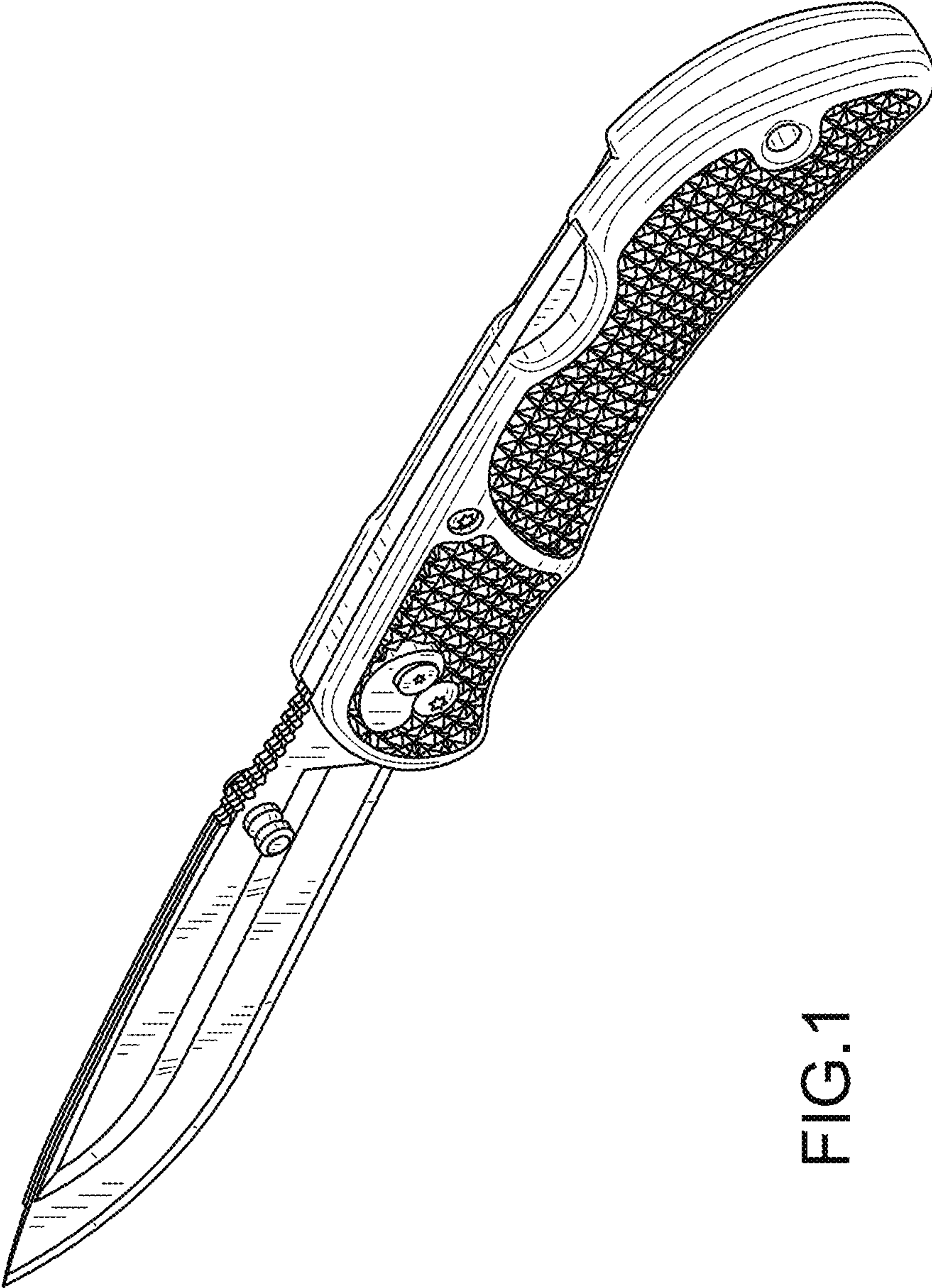

FIG.1

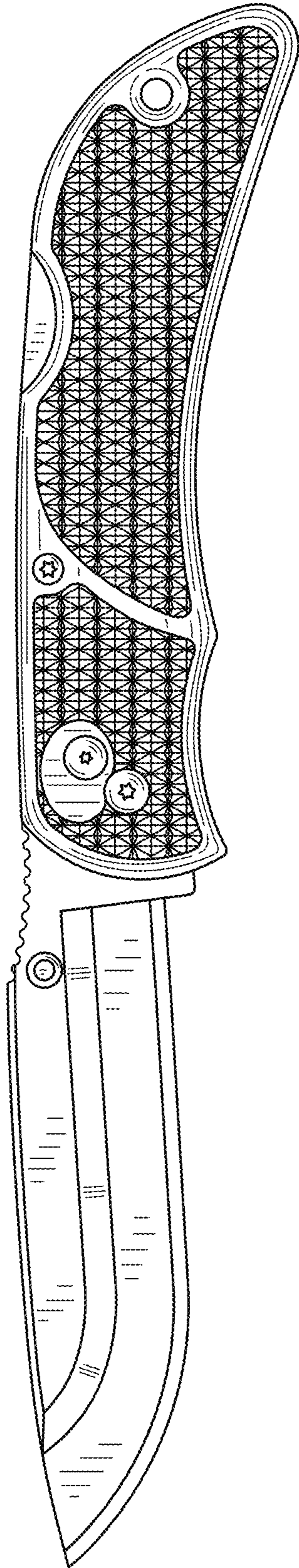

FIG. 2

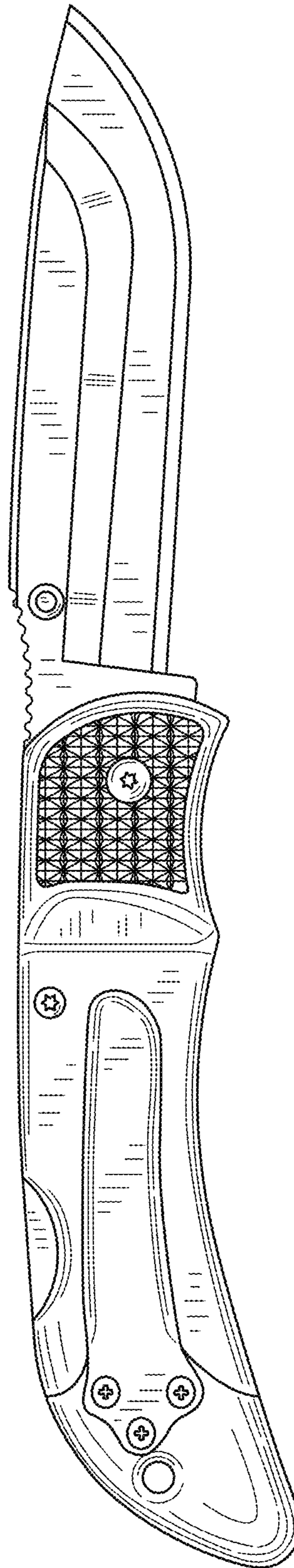

FIG. 3

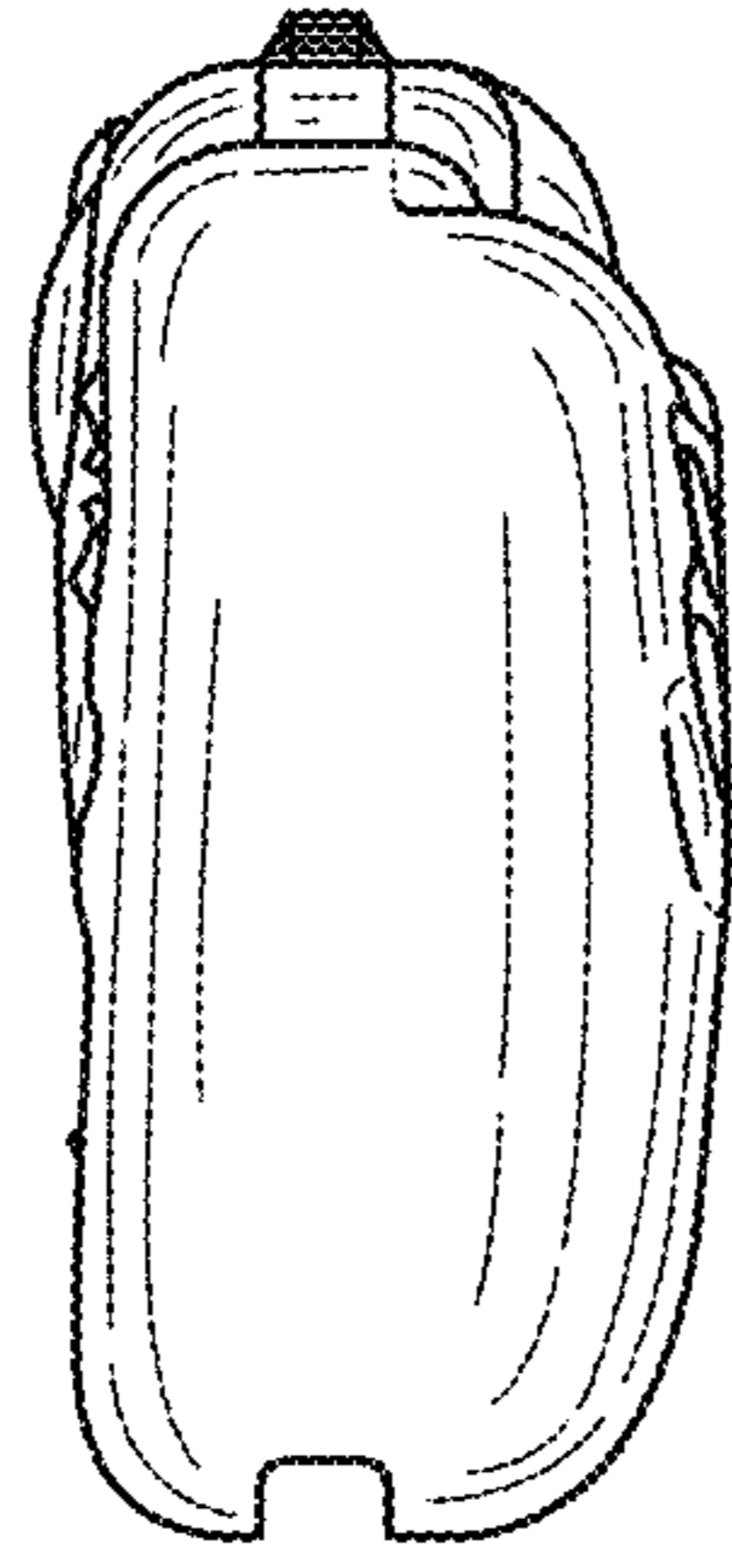

FIG.4

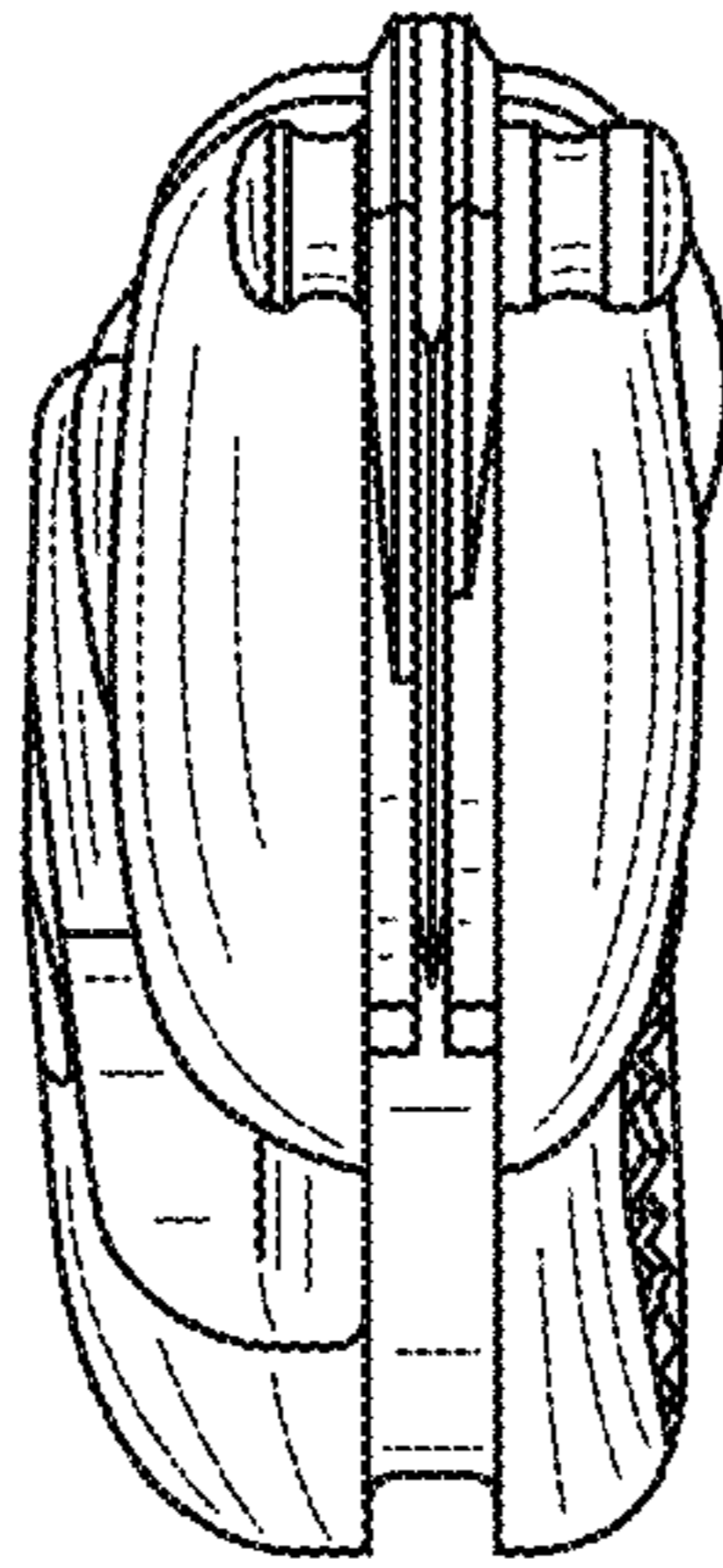

FIG.5

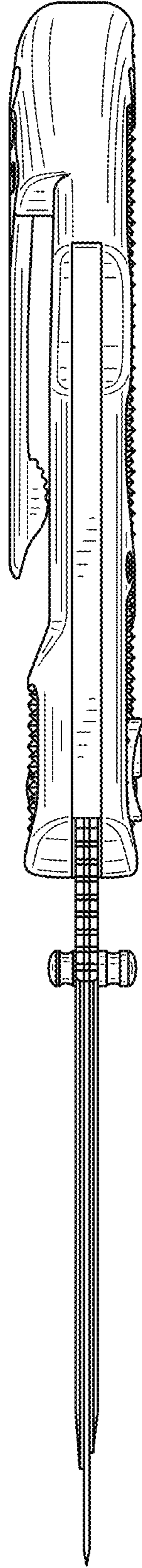

FIG. 6

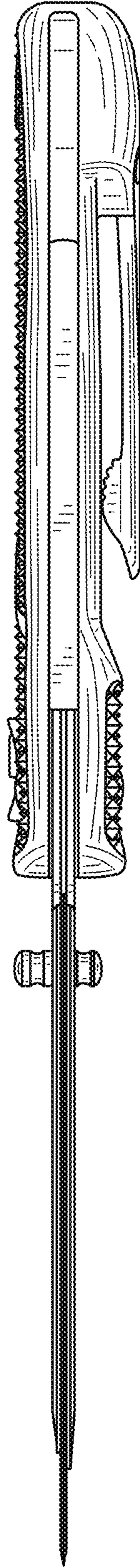

FIG. 7