



US00D806482S

(12) **United States Design Patent**
Palotto

(10) **Patent No.:** **US D806,482 S**

(45) **Date of Patent:** **** Jan. 2, 2018**

- (54) **BOWL**
- (71) Applicant: **Dart Industries Inc.**, Orlando, FL (US)
- (72) Inventor: **Simone Palotto**, Etterbeek (BE)
- (73) Assignee: **Dart Industries Inc.**, Orlando, FL (US)
- (**) Term: **15 Years**
- (21) Appl. No.: **29/583,624**
- (22) Filed: **Nov. 8, 2016**
- (51) **LOC (11) Cl.** **07-07**
- (52) **U.S. Cl.**
USPC **D7/602**
- (58) **Field of Classification Search**
USPC D7/602, 500, 503, 509, 510, 523, 543,
D7/552.2, 553.6, 557, 565, 566, 570, 584,
D7/586, 587; D3/306; 147/18; 217/122;
220/23.83, 574
CPC A24F 5/00; E03D 11/08; A47J 43/0727
See application file for complete search history.

- D634,970 S 3/2011 Palotto
- D651,865 S * 1/2012 Smyers D7/584
- D652,258 S * 1/2012 Lee D7/543
- D661,943 S 6/2012 Palotto et al.
- D715,594 S * 10/2014 Norland D7/545
- D787,274 S * 5/2017 Gagnon D7/586

* cited by examiner

Primary Examiner — Wan Laymon
Assistant Examiner — Mark Booker
(74) *Attorney, Agent, or Firm* — Taylor J. Ross

(57) **CLAIM**

The ornamental design for a bowl, as shown and described.

DESCRIPTION

FIG. 1 is a top, front and left side perspective view of a bowl showing my new design;
 FIG. 2 is a bottom, rear and left side perspective view thereof;
 FIG. 3 is a top plan view thereof;
 FIG. 4 is a bottom plan view thereof;
 FIG. 5 is a front elevation view thereof;
 FIG. 6 is a rear elevation view thereof;
 FIG. 7 is a left side elevation view, the right side being a mirror image thereof;
 FIG. 8 is a cross-sectional view taken along line 8-8 of FIG. 3; and,
 FIG. 9 is a cross-sectional view taken along line 9-9 of FIG. 3.

(56) **References Cited**

U.S. PATENT DOCUMENTS

- D383,646 S * 9/1997 Jeppesen D7/543
- D521,319 S * 5/2006 Haataja D7/543

1 Claim, 9 Drawing Sheets

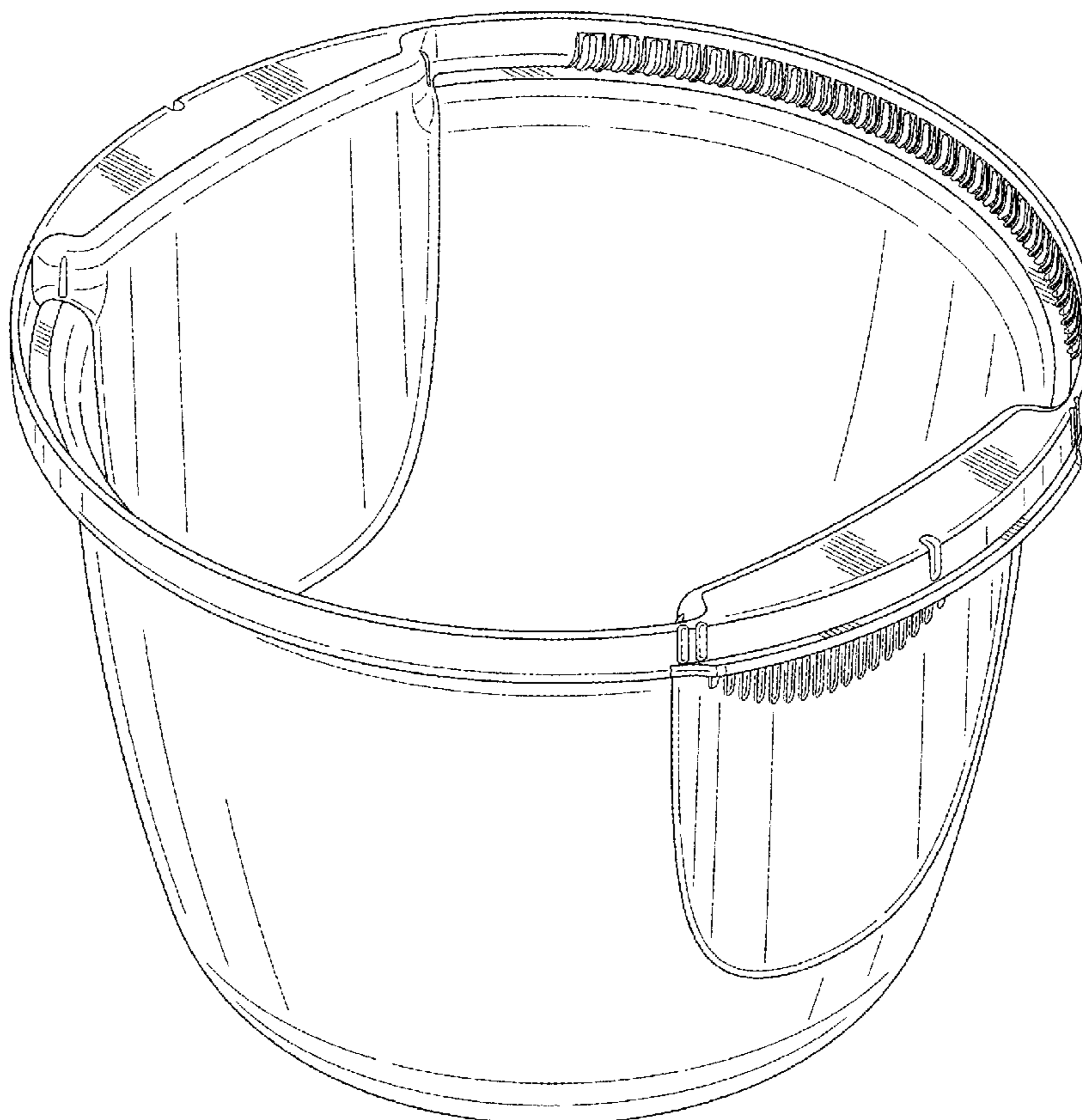

FIG. 1

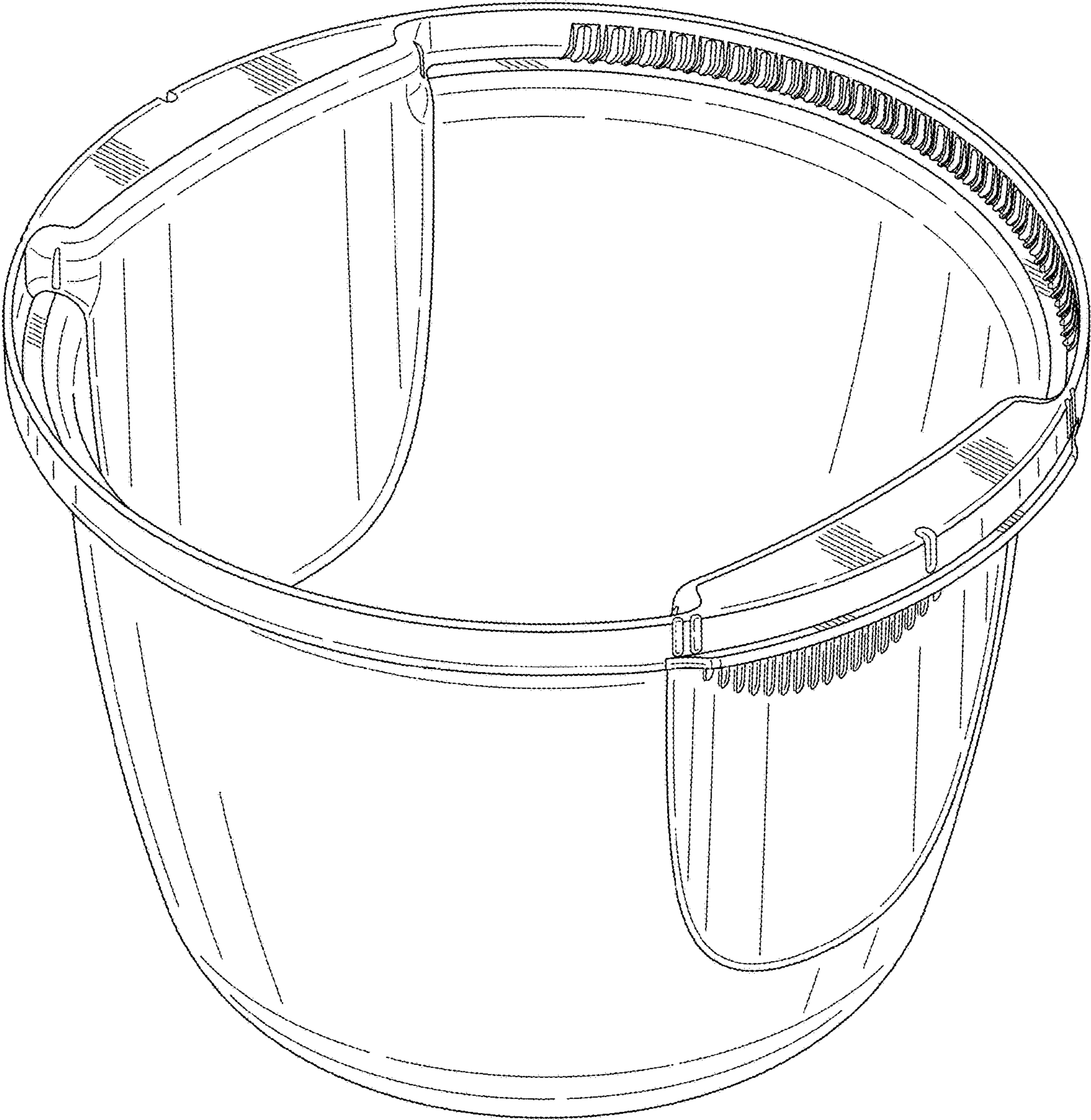
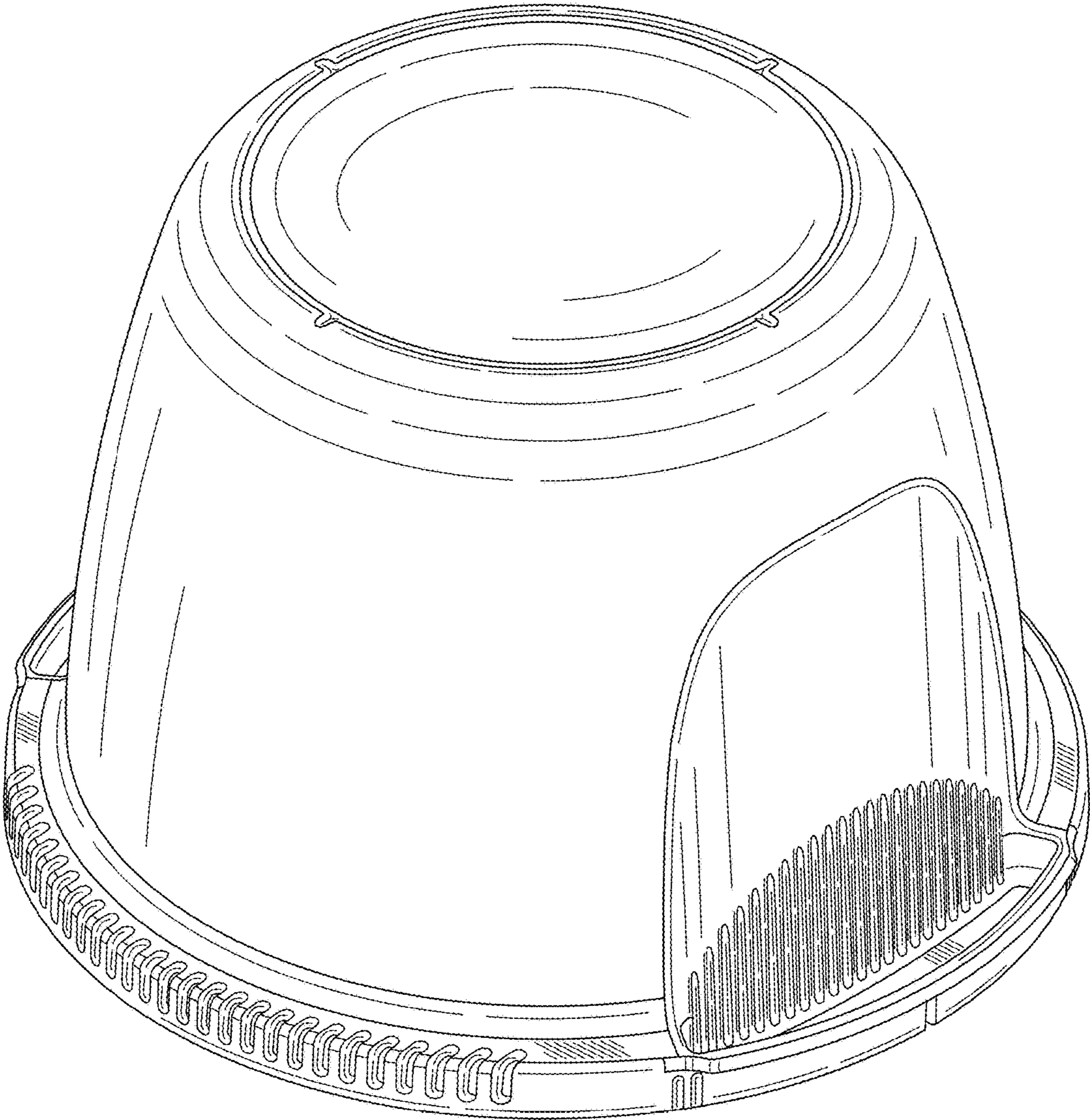

FIG. 2



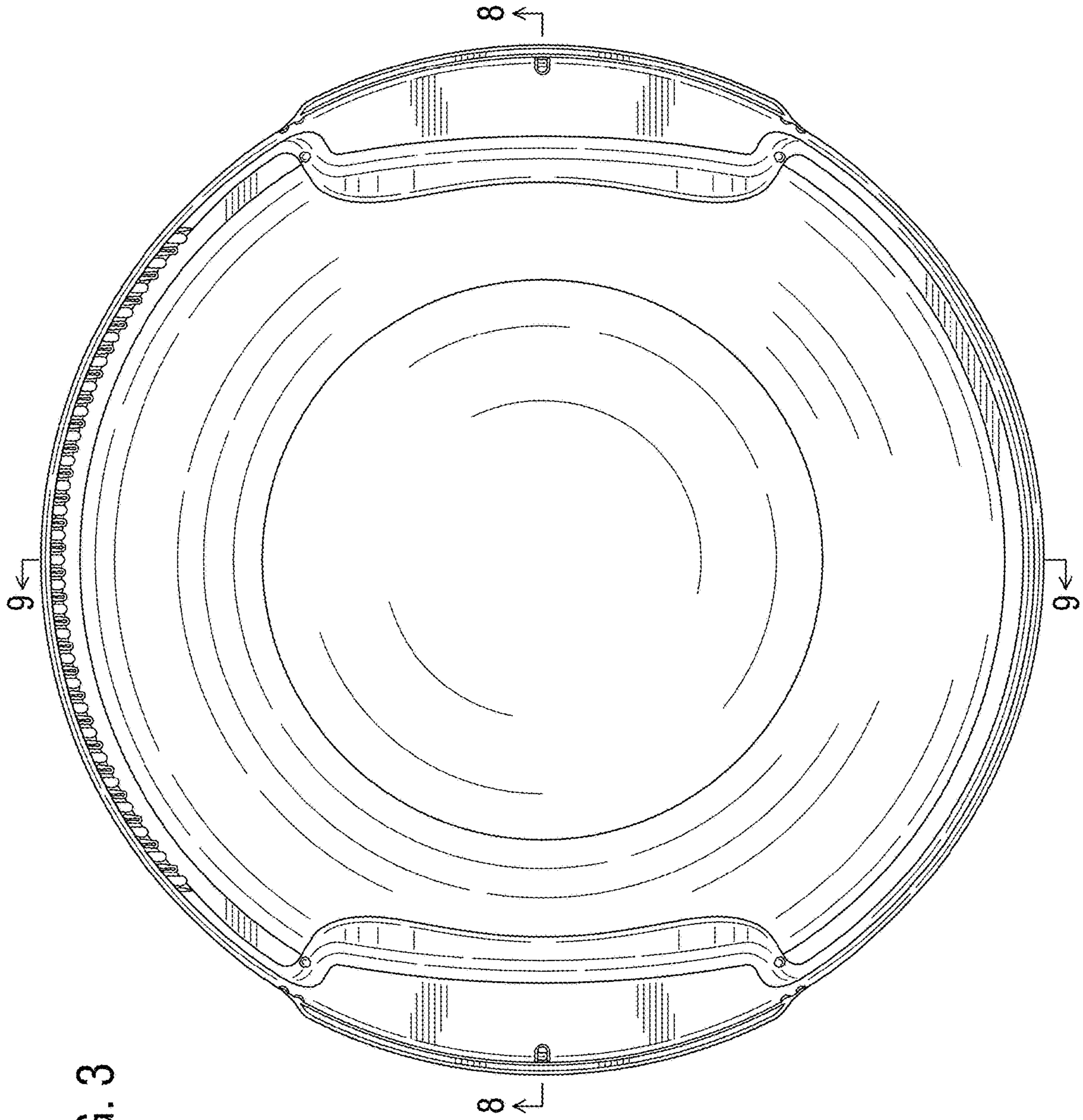

FIG. 3

FIG. 4

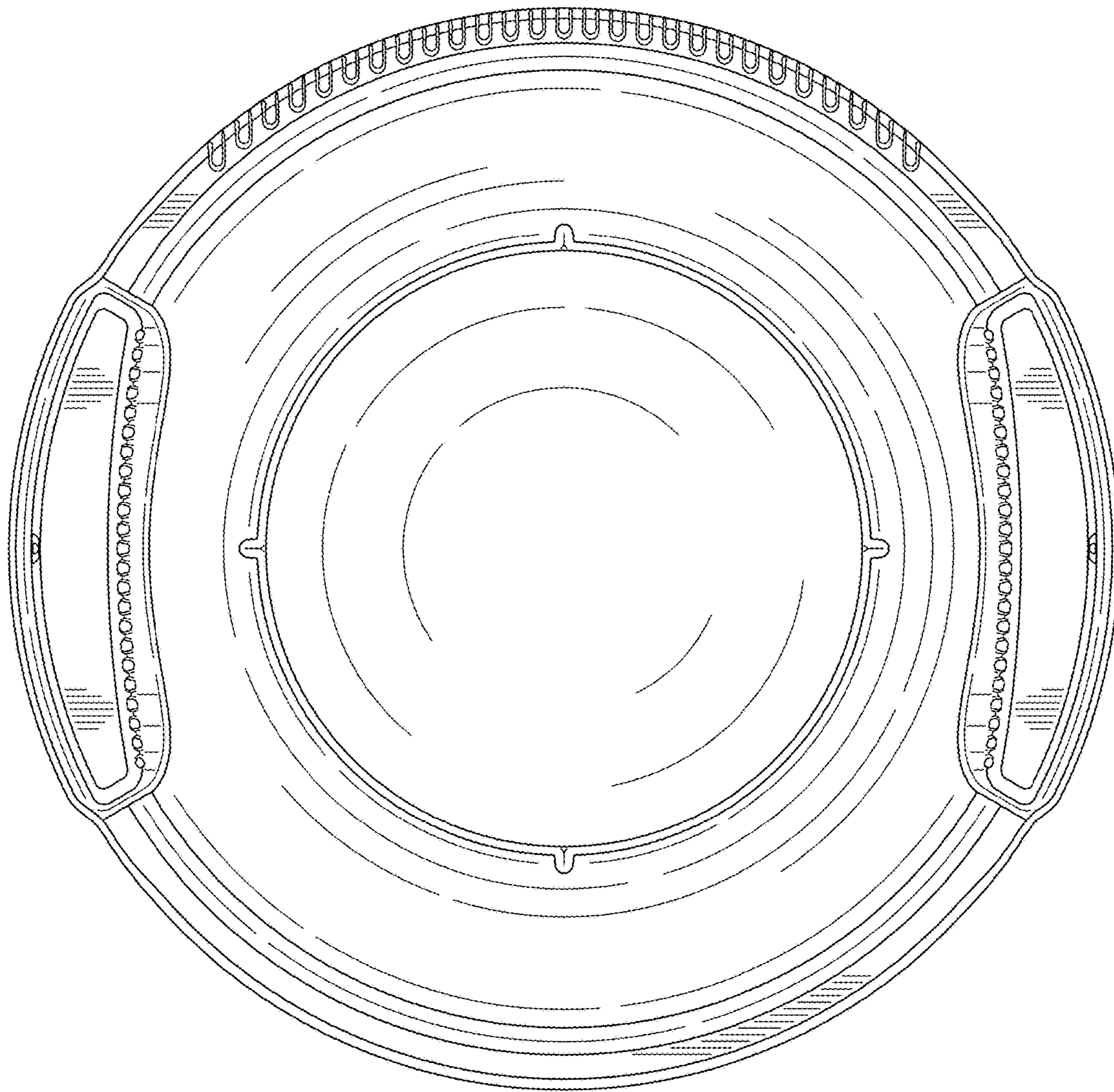

FIG. 5



FIG. 6

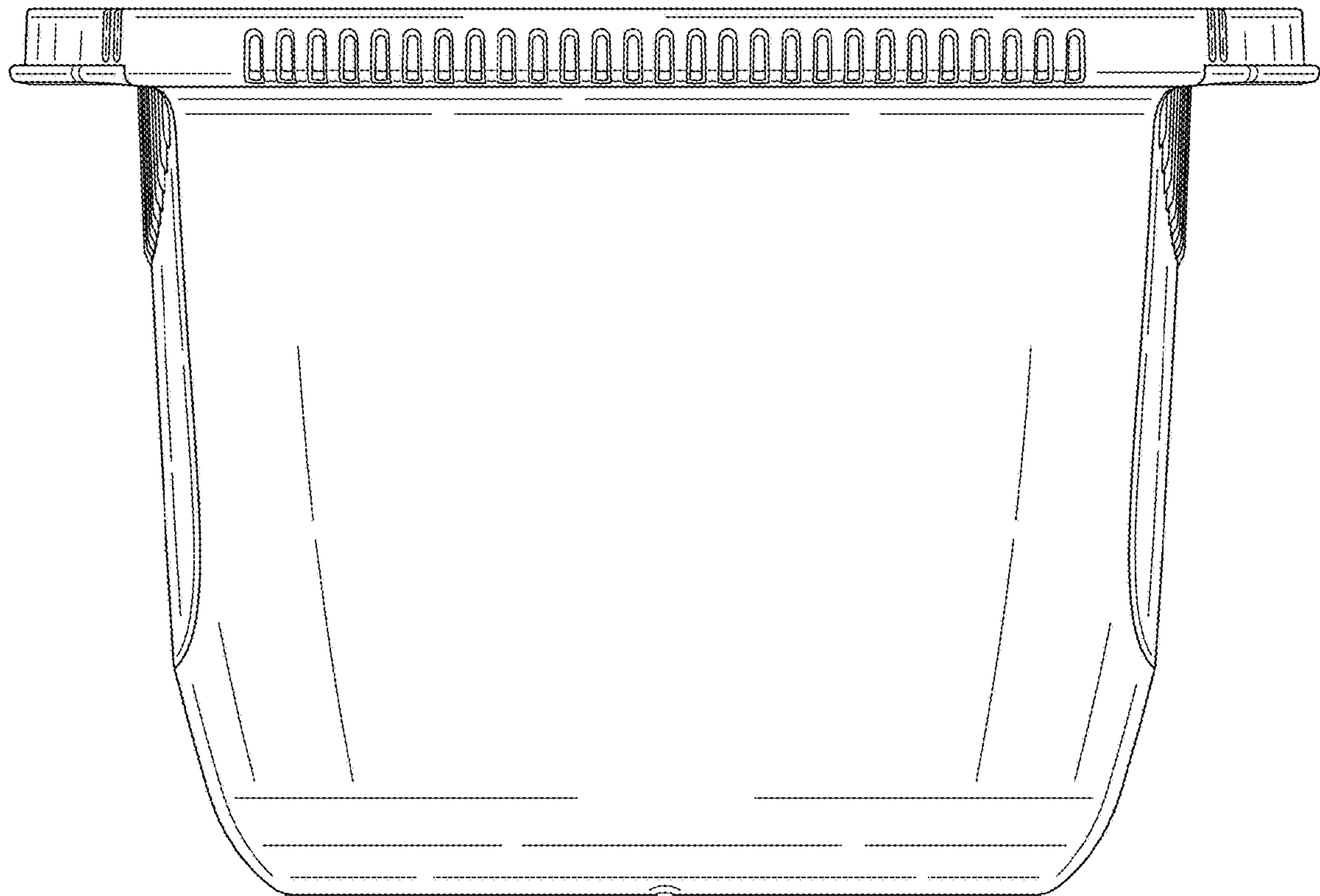

FIG. 7

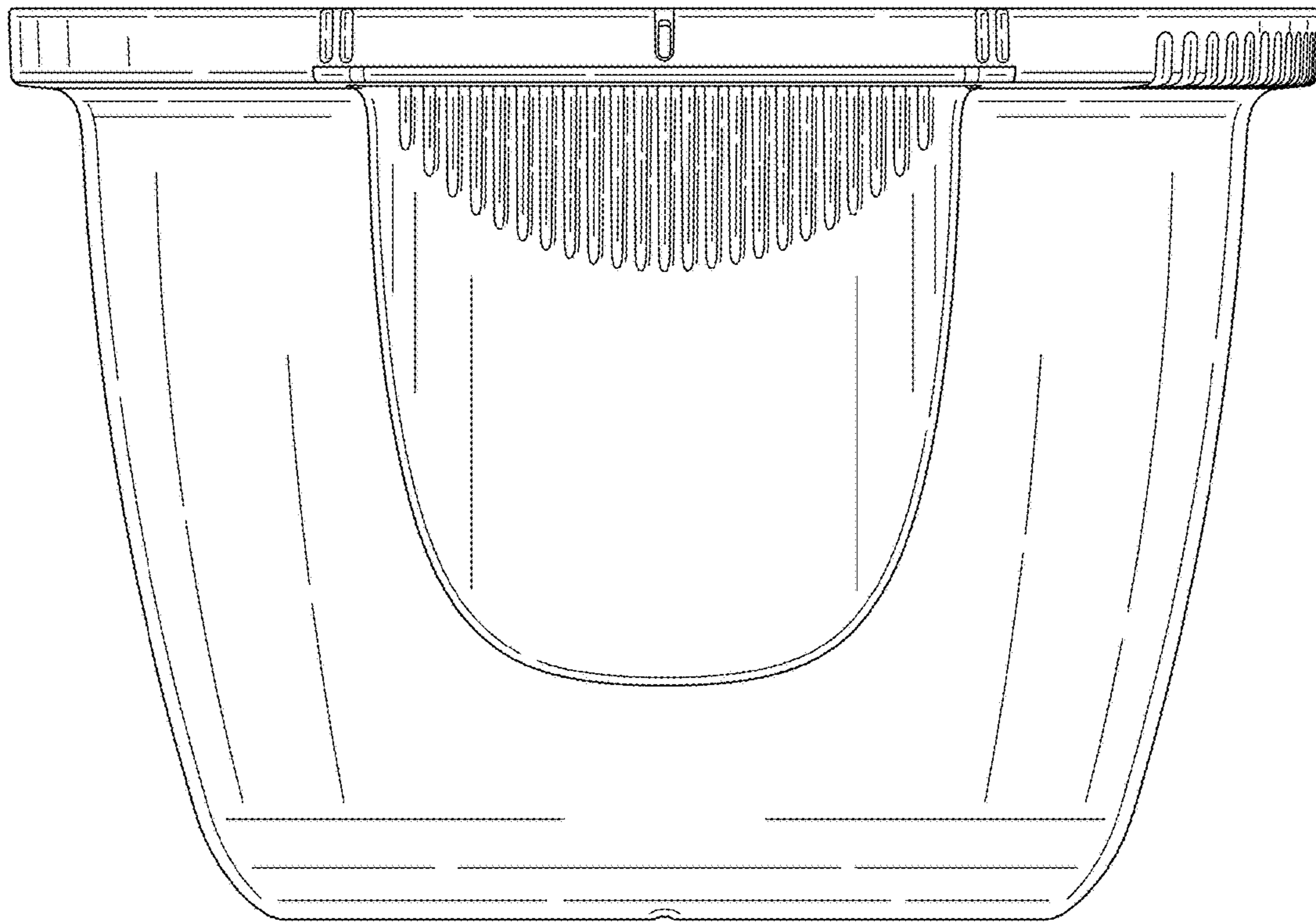

FIG. 8

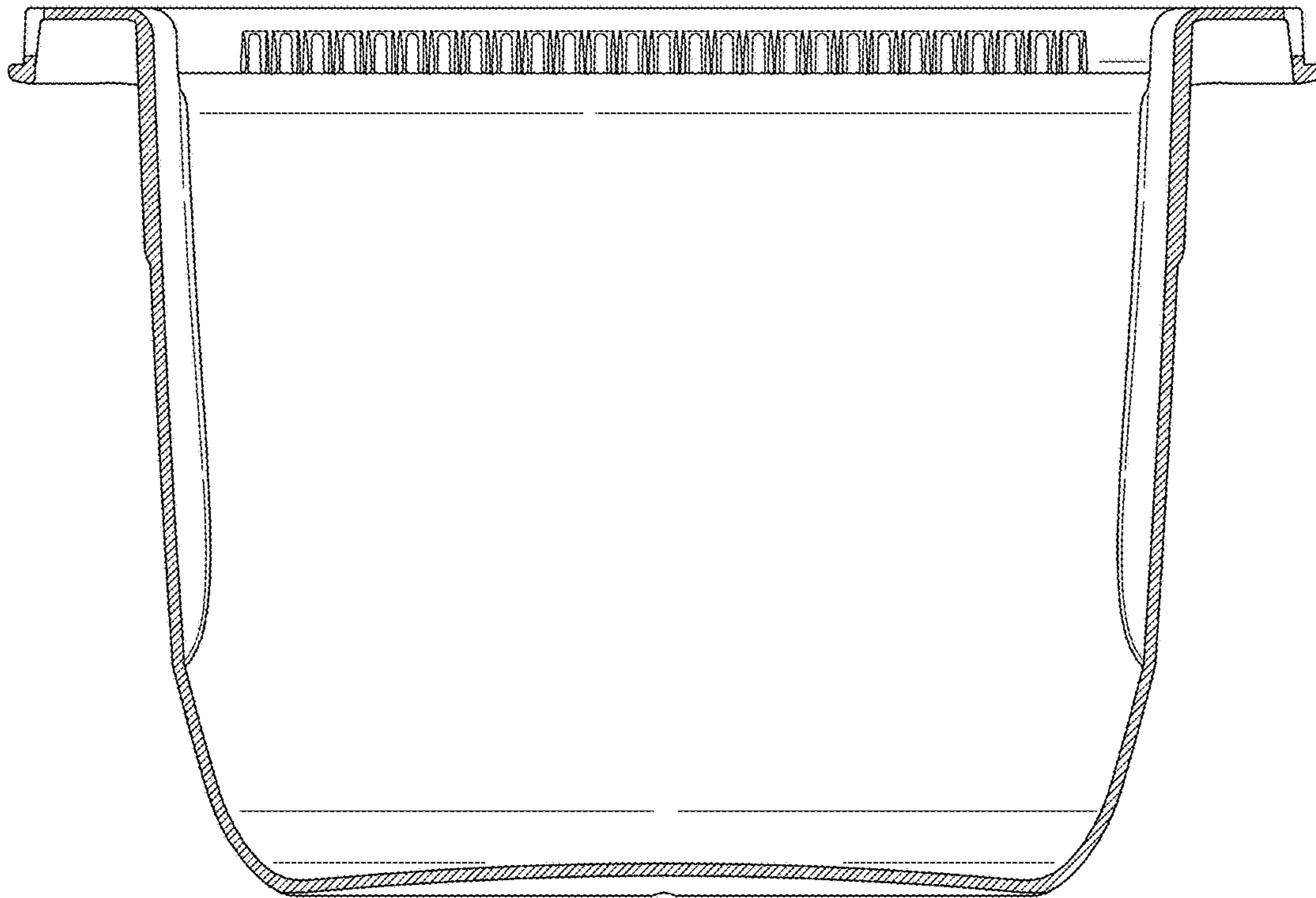

FIG. 9

