



US00D806461S

(12) **United States Design Patent** (10) **Patent No.:** **US D806,461 S**
Upston (45) **Date of Patent:** **** Jan. 2, 2018**

(54) **FOOD SMOKING GUN**

(56) **References Cited**

(71) Applicant: **Breville Pty Limited**, Alexandria, NSW (AU)

U.S. PATENT DOCUMENTS

(72) Inventor: **Greg Upston**, Eumundi (AU)

D47,660 S * 7/1915 Wear et al. D7/373
 2,662,753 A * 12/1953 Schwarz A47J 43/044
 188/82.7

(73) Assignee: **Breville Pty Limited**, Alexandria (AU)

D483,221 S * 12/2003 Ledingham D7/373
 D530,146 S * 10/2006 Ball D7/379
 D584,916 S * 1/2009 Christou D7/376
 D613,549 S * 4/2010 Picozza D7/376
 D677,520 S * 3/2013 Choi D7/376
 8,438,971 B1 * 5/2013 Thurley A47J 43/044
 366/146

(**) Term: **15 Years**

(21) Appl. No.: **29/584,034**

D753,434 S * 4/2016 Bazzicalupo D7/376
 D796,254 S * 9/2017 Thomas D7/376
 2017/0138782 A1 * 5/2017 Beber A47J 42/38

(22) Filed: **Nov. 10, 2016**

* cited by examiner

(30) **Foreign Application Priority Data**

May 11, 2016 (AU) 201612535

Primary Examiner — Ricky Pham

(51) **LOC (11) Cl.** **31-00**

(74) *Attorney, Agent, or Firm* — Moser Taboada

(52) **U.S. Cl.**

(57) **CLAIM**

USPC **D7/323**; D7/379

The ornamental design for a food smoking gun, as shown and described.

(58) **Field of Classification Search**

DESCRIPTION

USPC D7/372-373, 376-386, 412-413, 602, D7/629, 665-666, 669, 679, 693-694

FIG. 1 is a front perspective view of a food smoking gun showing the new design;

CPC A21C 1/02; A21C 1/04; A23N 1/00; A23N

FIG. 2 is a rear perspective view thereof;

1/02; A47J 42/38; A47J 43/04; A47J

FIG. 3 is a front view thereof;

43/25; A47J 43/27; A47J 43/042; A47J

FIG. 4 is a rear view thereof;

43/044; A47J 43/046; A47J 43/075; A47J

FIG. 5 is a left view thereof;

43/0716; A47J 43/0722; A47J 43/0727;

FIG. 6 is a right view thereof;

B01F 3/00; B01F 3/0807; B01F 3/0853;

FIG. 7 is a top view thereof; and,

B01F 13/0059; B01F 13/0064; B02C

FIG. 8 is a bottom view thereof.

1/08; B02C 2/04; B02C 4/42; B02C

4/142; B02C 4/143; B02C 4/423; B02C

13/1835; B02C 25/00; B28C 5/10; B28C

5/12; B28C 5/14; B28C 5/16

See application file for complete search history.

1 Claim, 8 Drawing Sheets

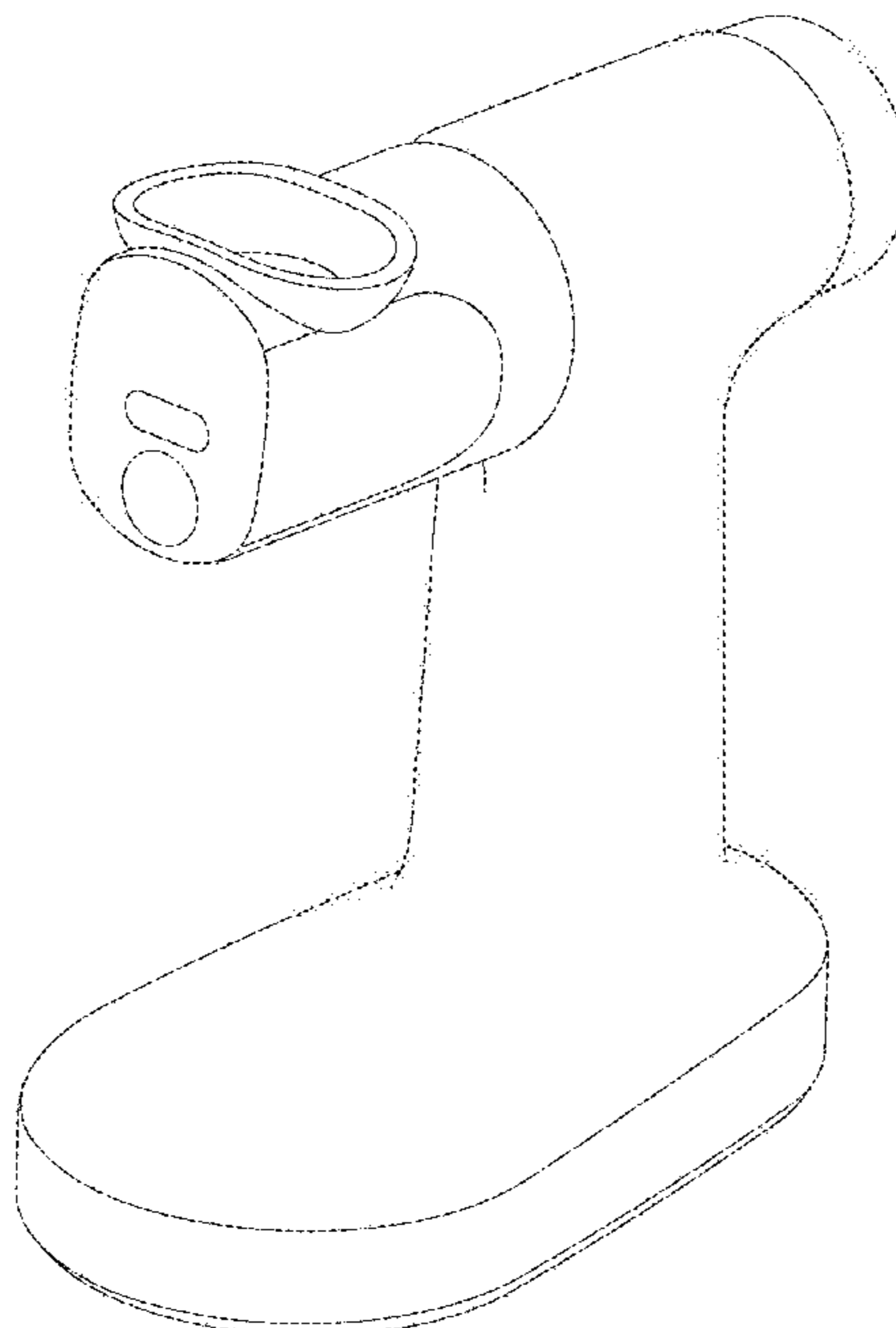

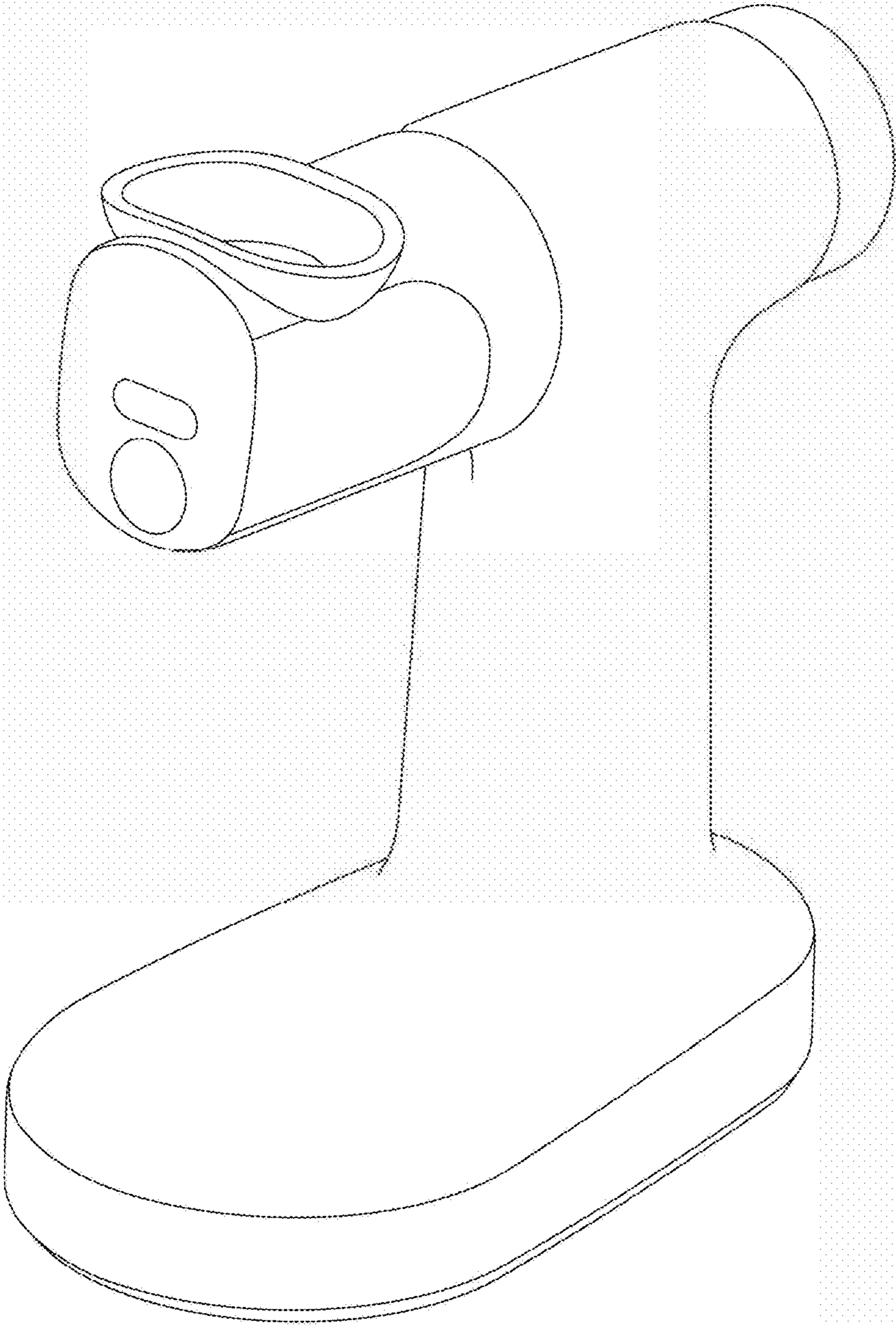

Figure 1

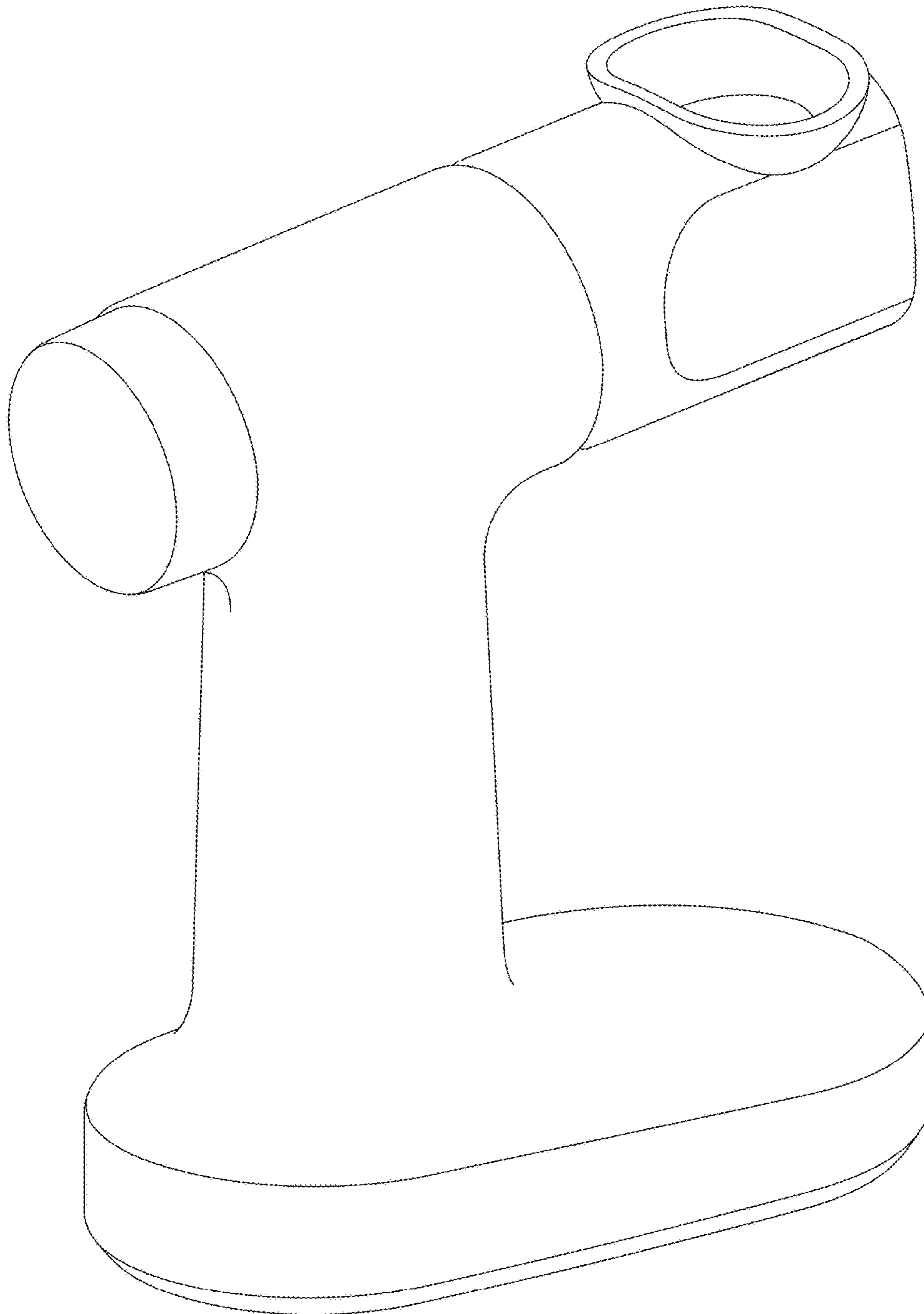

Figure 2

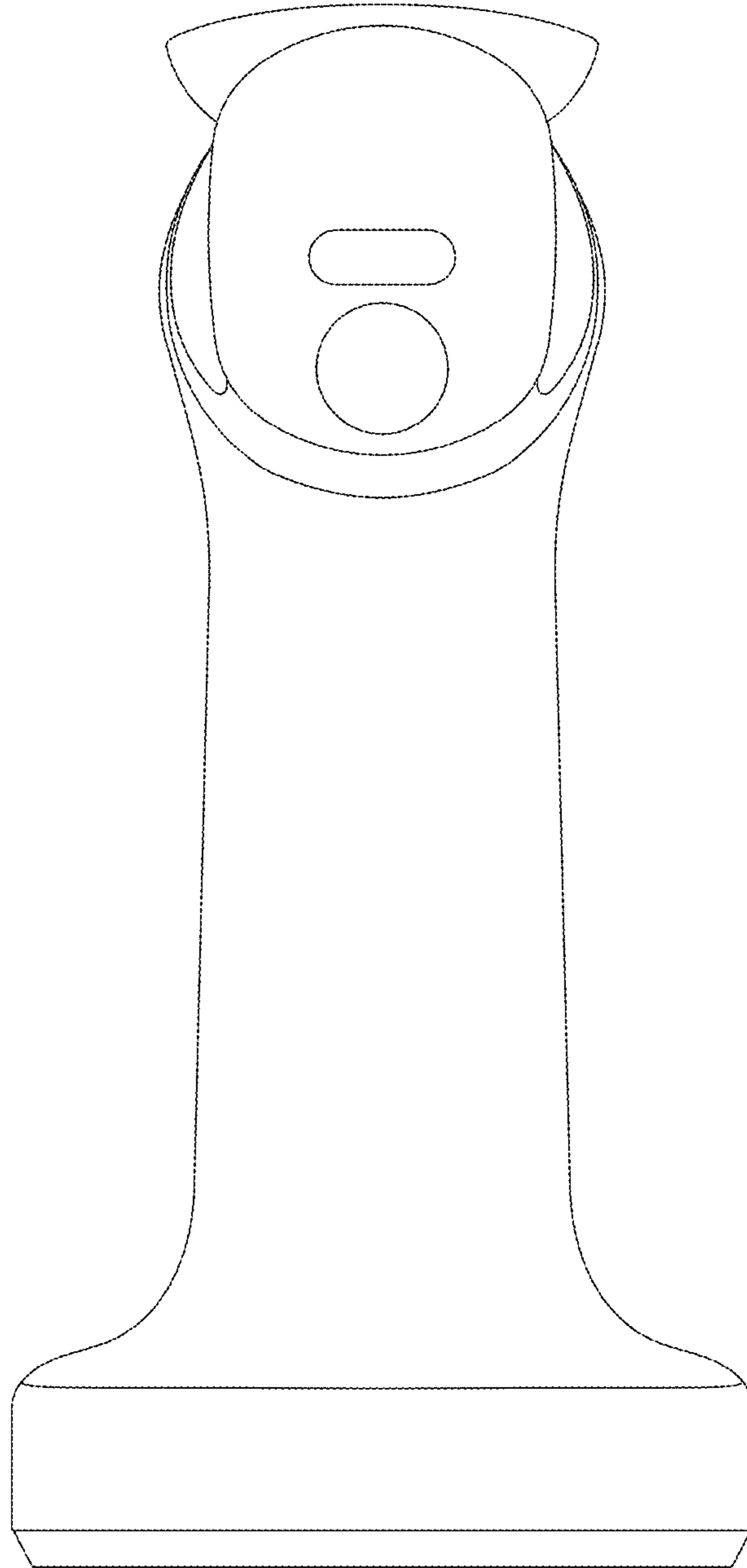

Figure 3

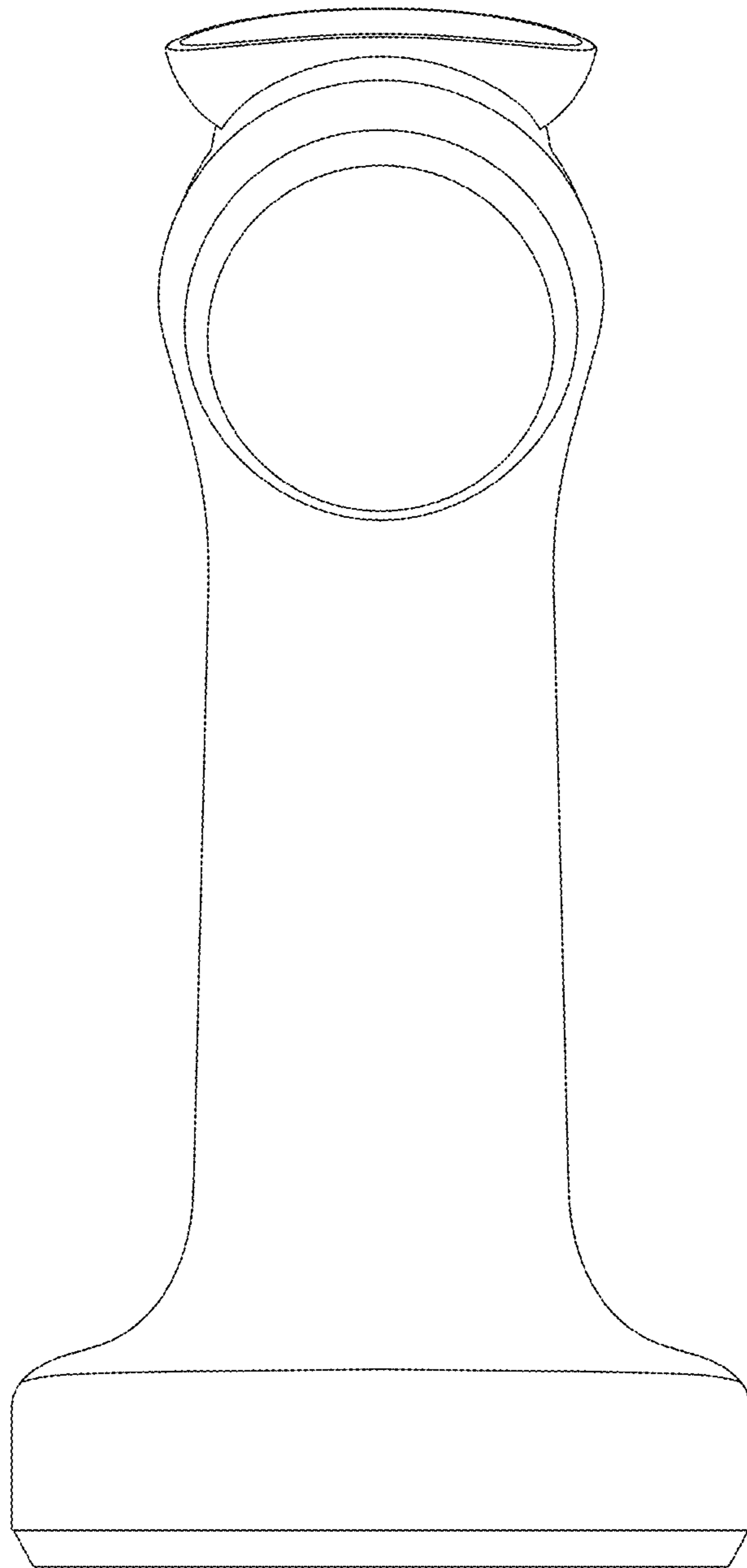

Figure 4

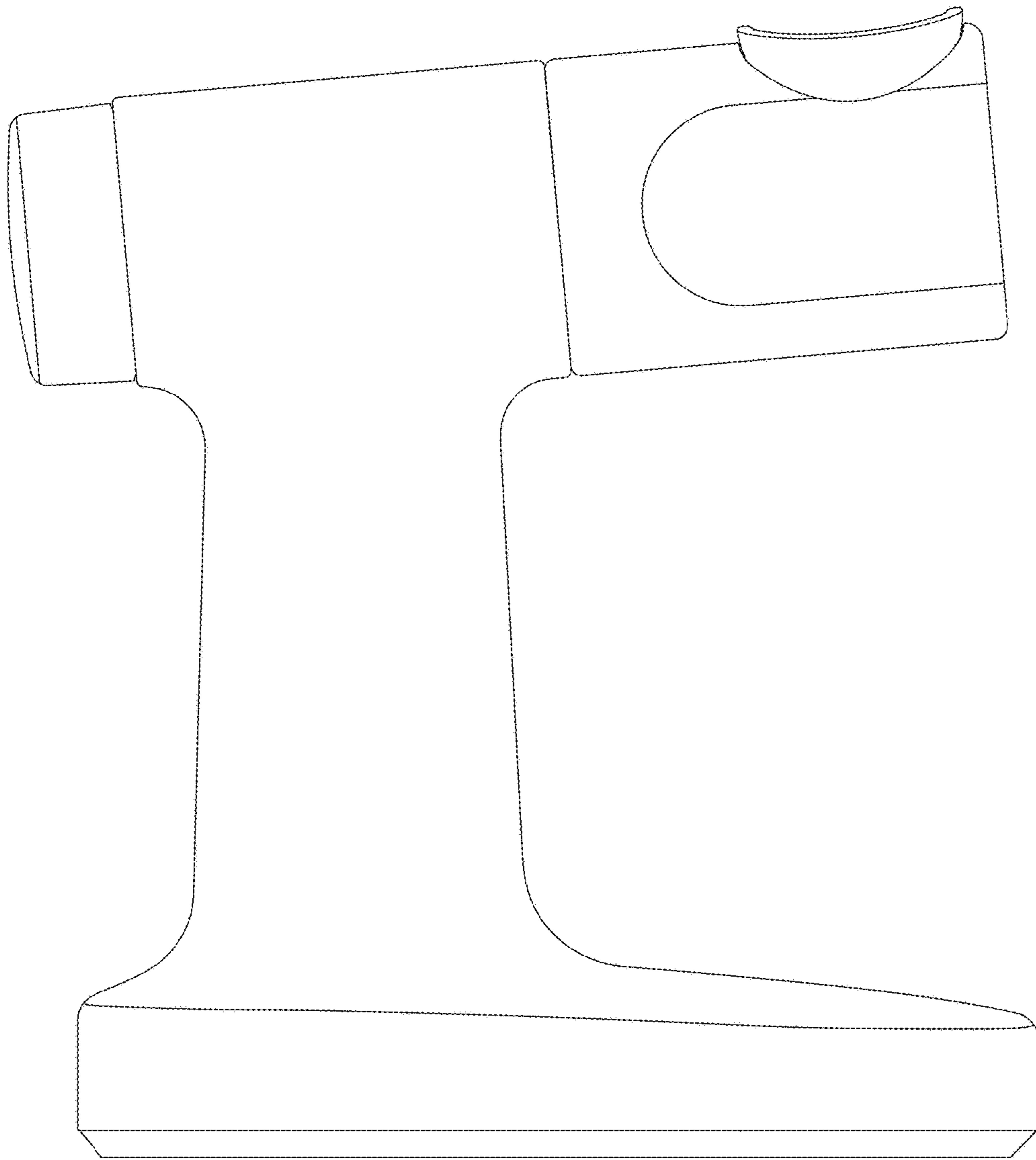

Figure 5

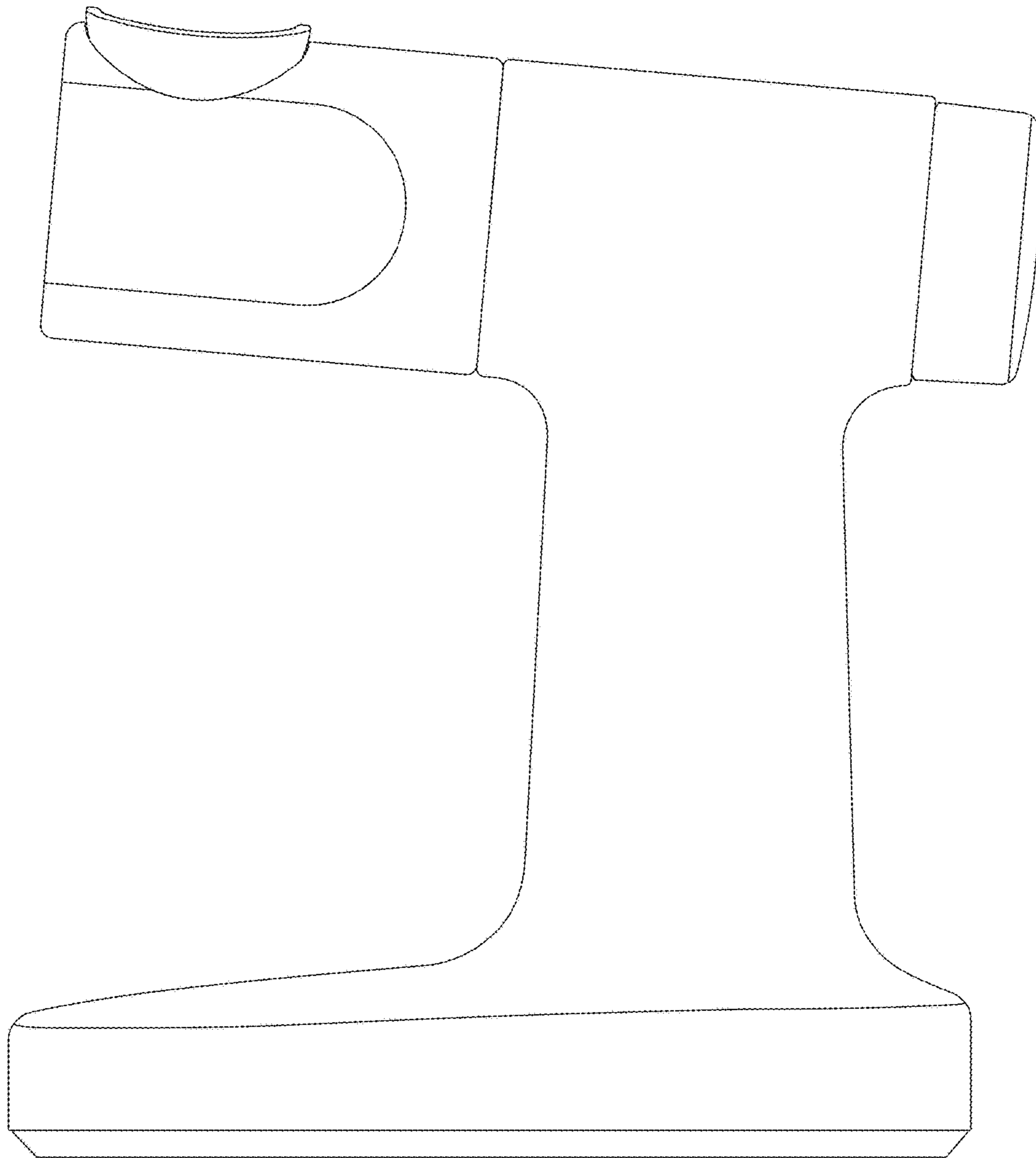

Figure 6

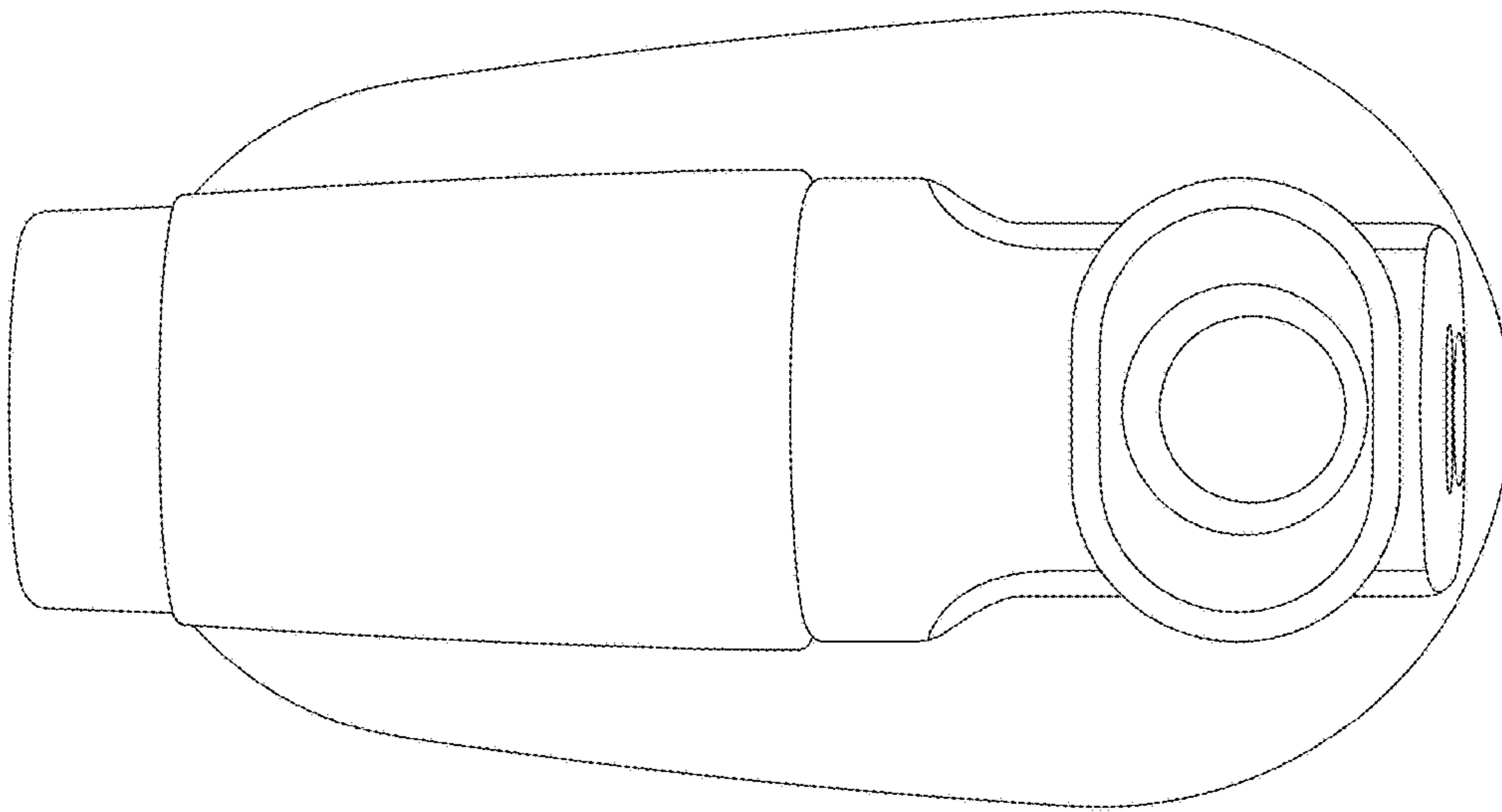

Figure 7

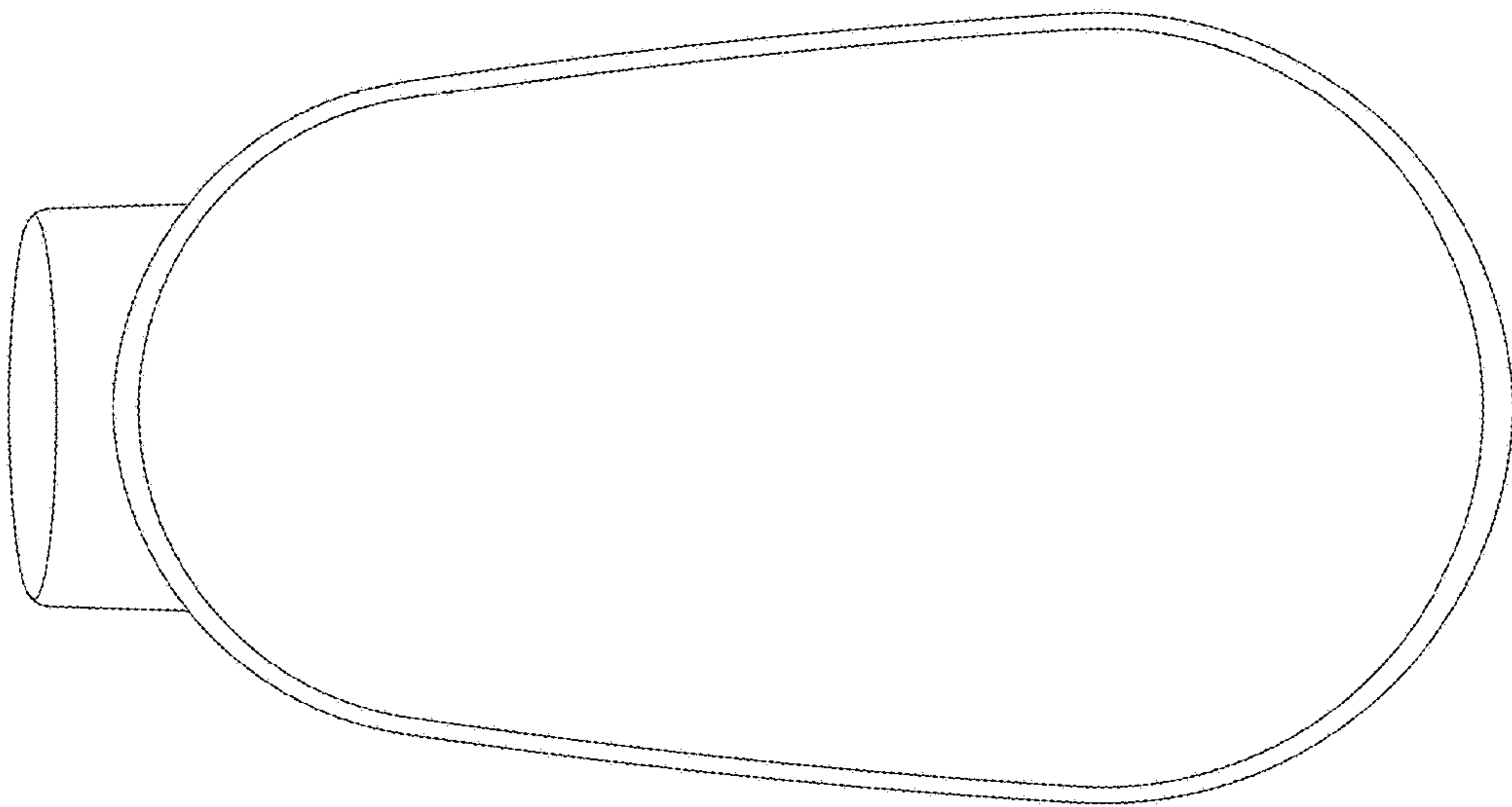

Figure 8