

US00D806445S

(12) **United States Design Patent**
Schiesser

(10) **Patent No.:** **US D806,445 S**
(45) **Date of Patent:** **** Jan. 2, 2018**

(54) **GOLF CART SEAT COVER**

(71) Applicant: **Image Solution Products Inc.**,
Williams Bay, WI (US)

(72) Inventor: **James Charles Schiesser**, Williams
Bay, WI (US)

(**) Term: **15 Years**

(21) Appl. No.: **29/562,786**

(22) Filed: **Apr. 28, 2016**

(51) **LOC (11) Cl.** **06-13**

(52) **U.S. Cl.**
USPC **D6/611**

(58) **Field of Classification Search**
USPC D6/334-336, 349, 351, 352, 358, 360,
D6/364, 365, 366, 374, 375, 379, 380,
(Continued)

(56) **References Cited**

U.S. PATENT DOCUMENTS

1,576,900 A * 3/1926 Collier A47C 4/30
160/383
5,288,135 A * 2/1994 Forcier A47C 7/022
297/452.21

(Continued)

OTHER PUBLICATIONS

“20” Dreamsweet Memory Foam Large Round Roll Pillow w/
Removable Cover, Beige” May 23, 2013, amazon.com, site visited
Feb. 23, 2017 <https://www.amazon.com/Dreamsweet-Memory-Large-Pillow-Removable/dp/B00BF1WNSA/ref=cm_cr_arp_d_product_top?ie=UTF8>.*

(Continued)

Primary Examiner — Kevin K Rudzinski
Assistant Examiner — Paul D Bohannon
(74) *Attorney, Agent, or Firm* — Invention To Patent
Services; Alex Hobson

(57) **CLAIM**

The ornamental design for a golf cart seat cover, as shown
and described.

DESCRIPTION

FIG. 1 is a perspective view of a golf cart seat cover on a golf
cart including a golf seat portion and golf seat-back portion;
FIG. 2 is a perspective view of a golf cart seat cover on a golf
cart;
FIG. 3 is a top view of a golf seat portion configured on a
golf seat support, shown separately from the golf seat-back
portion for ease of illustration;
FIG. 4 is a front view of a golf seat portion configured on a
golf seat support, shown separately from the golf seat-back
portion for ease of illustration;
FIG. 5 is a back view of a golf seat portion configured on a
golf seat support, shown separately from the golf seat-back
portion for ease of illustration;
FIG. 6 is a bottom view of a golf seat portion configured on
a golf seat support, shown separately from the golf seat-back
portion for ease of illustration;
FIG. 7 is a perspective left side view of a golf seat portion
configured on a golf seat support, shown separately from the
golf seat-back portion for ease of illustration;
FIG. 8 is a perspective right side view of a golf seat portion
configured on a golf seat support, shown separately from the
golf seat-back portion for ease of illustration;
FIG. 9 is a perspective right side view of a golf seat portion
configured on a golf seat support, shown separately from the
golf seat-back portion for ease of illustration;
FIG. 10 is a perspective left side view of a golf seat portion
configured on a golf seat support, shown separately from the
golf seat-back portion for ease of illustration;
FIG. 11 is a front view of a golf seat-back portion configured
on a golf seat-back support, shown separately from the golf
seat portion for ease of illustration;
FIG. 12 is a perspective bottom view of a golf seat-back
portion configured on a golf seat-back support, shown
separately from the golf seat portion for ease of illustration;
FIG. 13 is a perspective top view of a golf seat-back portion
configured on golf seat-back support, shown separately from
the golf seat portion for ease of illustration;

(Continued)

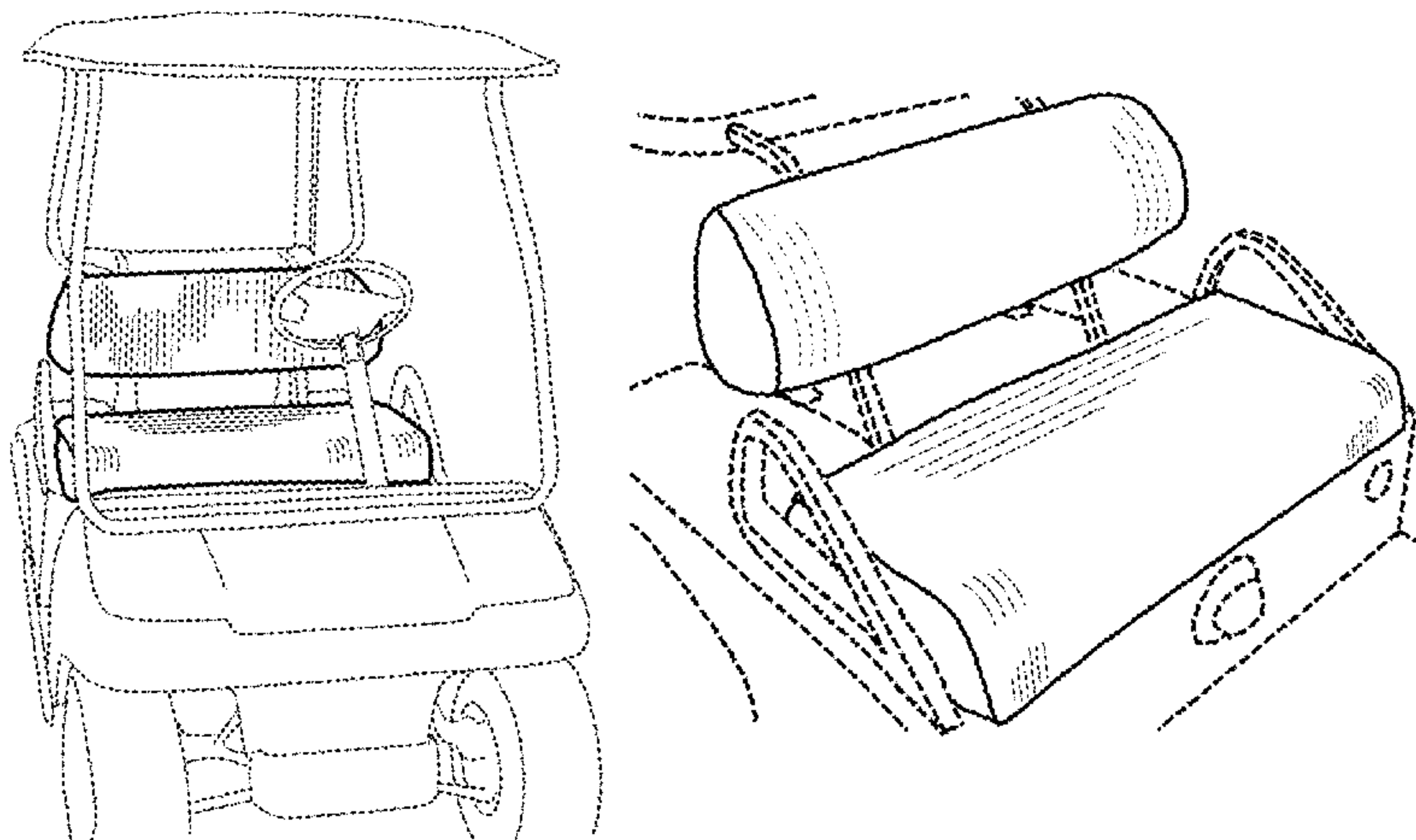

FIG. 14 is a perspective left side view of a golf seat-back portion configured on a golf seat-back support, shown separately from the golf seat portion for ease of illustration; FIG. 15 is a perspective right side view of a golf seat-back portion configured on a golf seat-back support, shown separately from the golf seat portion for ease of illustration; and, FIG. 16 is a back view of a golf seat-back portion configured on a golf seat-back port, shown separately from the golf seat portion for ease of illustration. The broken lines shown in FIGS. 1-16 are the purpose of illustrating environmental structure, such as golf cart, seat support and seat-back support, and form no part of the claimed design.

1 Claim, 16 Drawing Sheets

(58) **Field of Classification Search**

USPC .. D6/611, 657, 662.1, 672, 674, 675, 675.1, D6/675.3, 683, 683.1, 685, 691, 691.5, D6/702, 708, 708.2, 708.21, 708.25, 716, D6/716.1-716.4; D3/304, 307, 309
 CPC A47C 1/143; A47C 31/00; A47C 31/11; A47C 31/08; A47C 31/10; A47C 31/105; A47C 31/113; A47C 31/116; A47C 4/28; A47C 4/283; A47C 4/286; A47C 4/30; A47C 4/32; A47C 4/34; A47C 4/36; A47C 4/38; A47C 4/40; A47C 4/42; A47C 4/44; A47C 4/46; A47C 4/48; A47C 4/50; A47C 4/54; A47C 5/00; A47C 5/005; A47C 5/02; A47C 7/02; A47C 7/36; A47C 7/50; A47C 7/54; A47C 7/62; A47C 7/66; A47C 17/00; A47C 17/045; A47C 17/22; A47C 17/86; A47C 19/205; A47C 21/00; A47C 21/022; A47C 21/026; A47C 21/028; A47C 21/042; A47C 27/001; A47C 27/002; A47C 27/003; A47C 27/005; A47C 27/006; A47C 27/007; A47C 27/008; A47C 27/05; A47C 27/053; A47C 27/056; A47C 27/067; B60N 2/60; B60N

2/2881; B60N 2/6018; B60N 2/6036
 See application file for complete search history.

(56)

References Cited

U.S. PATENT DOCUMENTS

5,407,247	A *	4/1995	Forcier	A47C 7/021 297/229
5,669,669	A *	9/1997	Usher	A47C 9/005 297/313
5,795,019	A *	8/1998	Wieclawski	B60N 2/2222 297/216.12
6,254,182	B1 *	7/2001	Townsend	A47C 31/116 297/219.1
6,279,993	B1 *	8/2001	Berthiaume	B60N 2/6063 297/219.1
D498,108	S *	11/2004	Bridge	D6/611
7,172,246	B1 *	2/2007	Itakura	B60N 2/6036 297/219.1
RE42,086	E *	2/2011	Saito	B60N 2/24 280/756
8,944,066	B1 *	2/2015	Kamau	A61G 13/123 128/845
2007/0262624	A1 *	11/2007	Snedeker	A47C 31/11 297/219.1
2015/0069803	A1 *	3/2015	Krankkala	B60N 2/60 297/224

OTHER PUBLICATIONS

“Classic Accessories Fairway Golf Cart Diamond Air Mesh Bench Seat Cover” Aug. 27, 2014, amazon.com, site visited Feb. 23, 2017 <https://www.amazon.com/Classic-Accessories-Fairway-Diamond-Cover/dp/B00KU00J6U/ref=cm_cr_arp_d_product_top?ie=UTF8>.*
 “Classic Accessories Golf Cart Seat Cover—Light Khaki” Dec. 23, 2015, etrailer.com, site visited Feb. 23, 2017 <<https://www.etrailer.com/Covers/Classic-Accessories/CA40029.html>>.*
 “Extra-Large TravelMate Seat Cushion (Size: 19×17×3 inches. Color Black)” Aug. 28, 2013, amazon.com, site visited Feb. 23, 2017 <https://www.amazon.com/Extra-Large-TravelMate-Seat-Cushion-Size/dp/B00CVYOAUY/ref=cm_cr_arp_d_product_top?ie=UTF8>.*

* cited by examiner

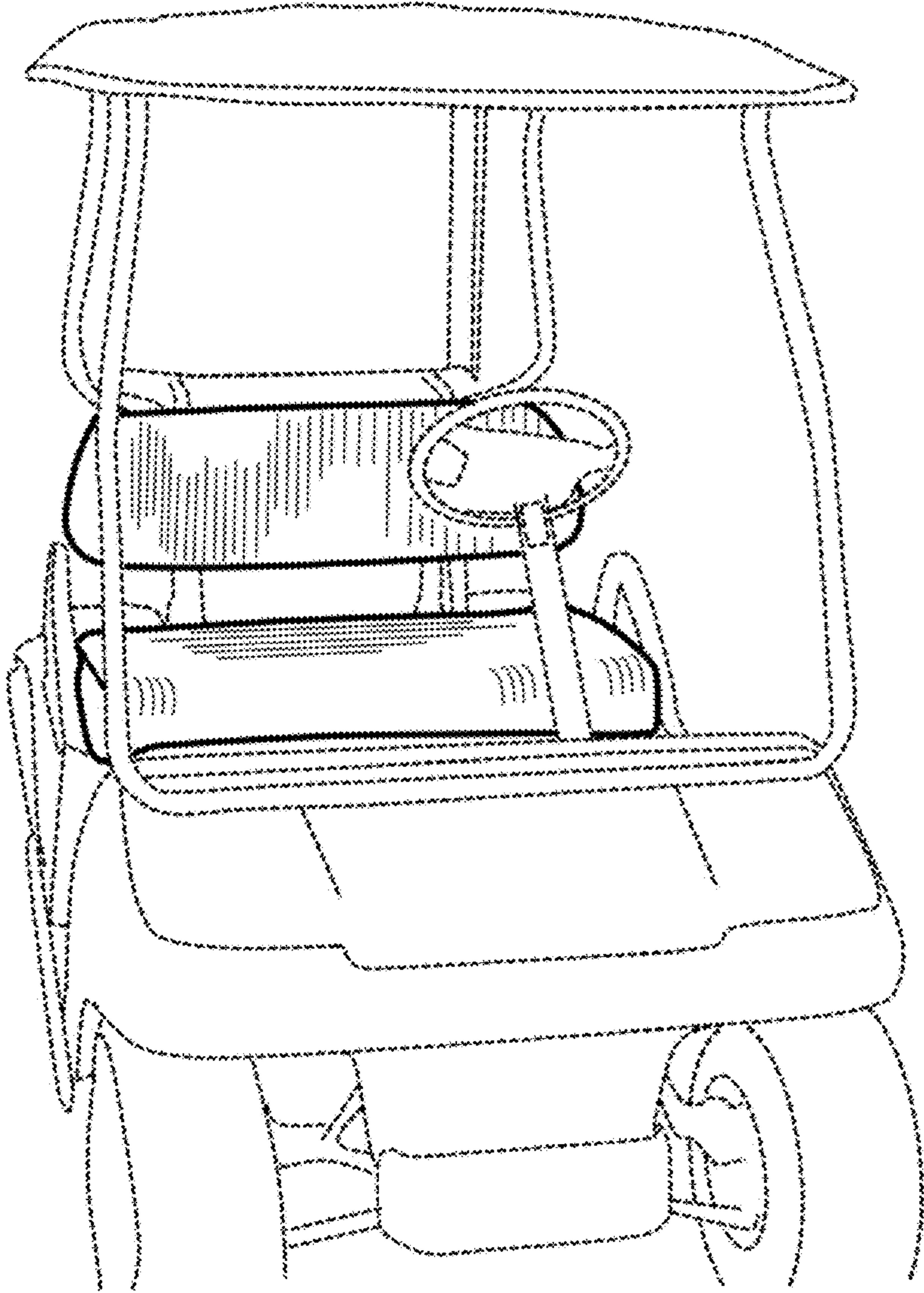

FIG. 1

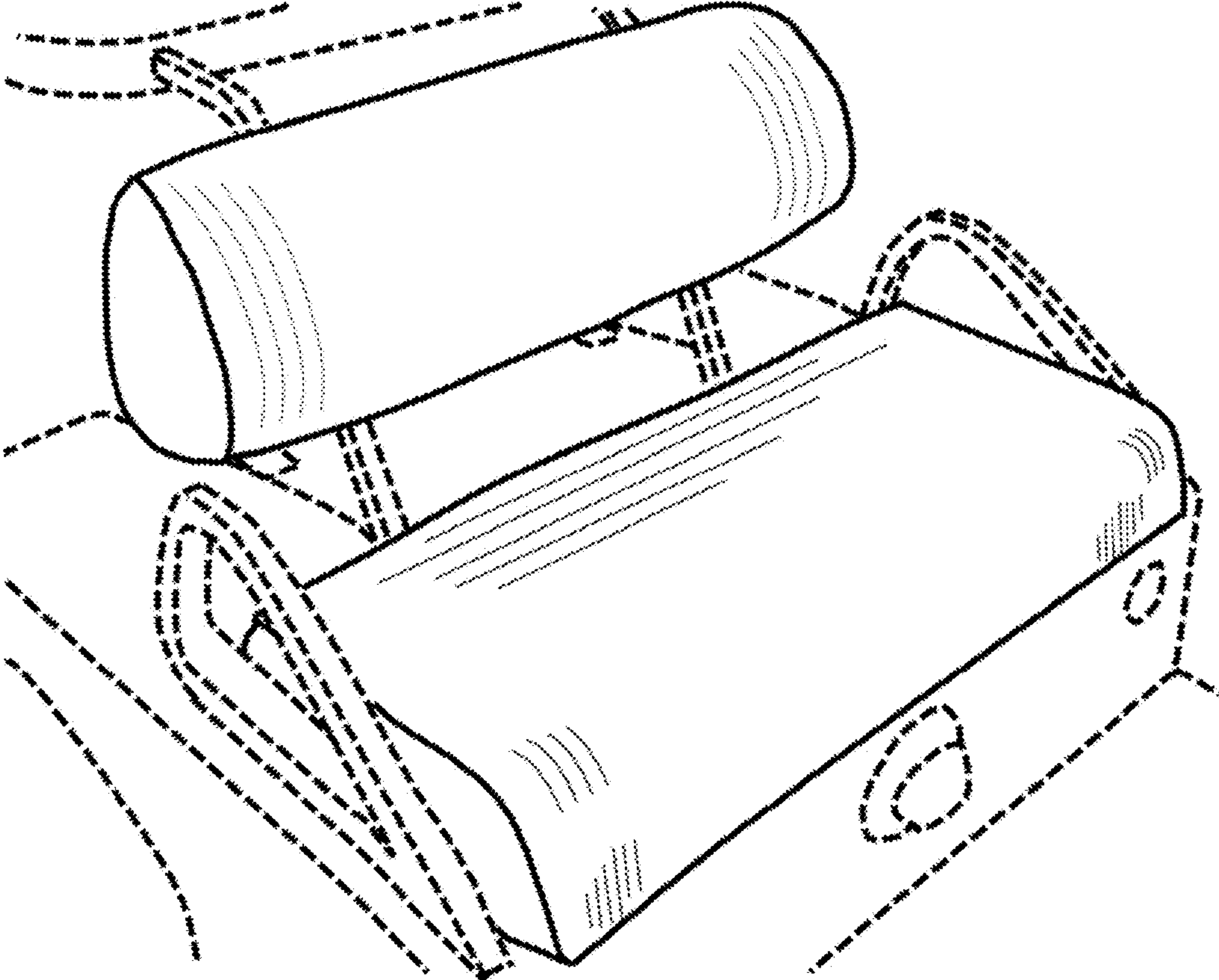

FIG. 2

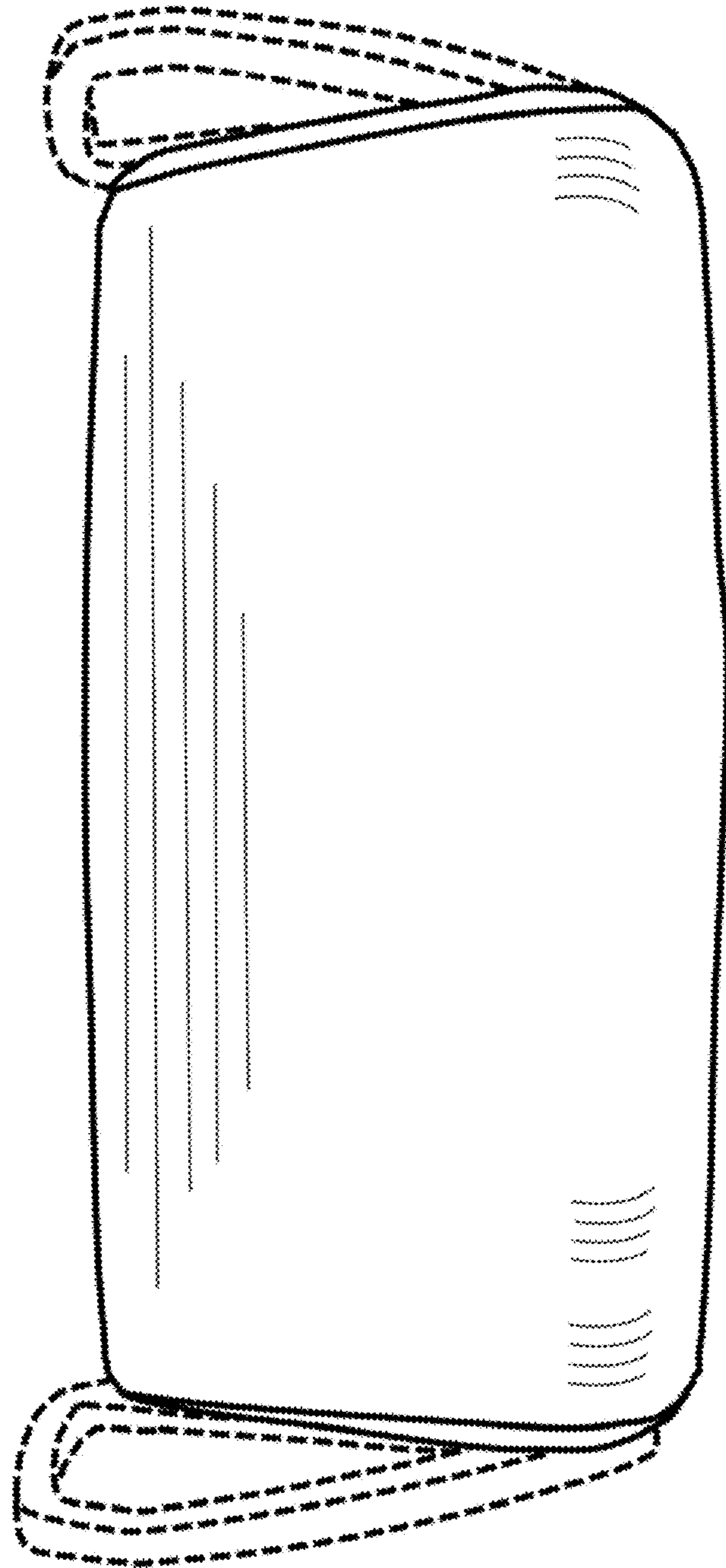

FIG. 3

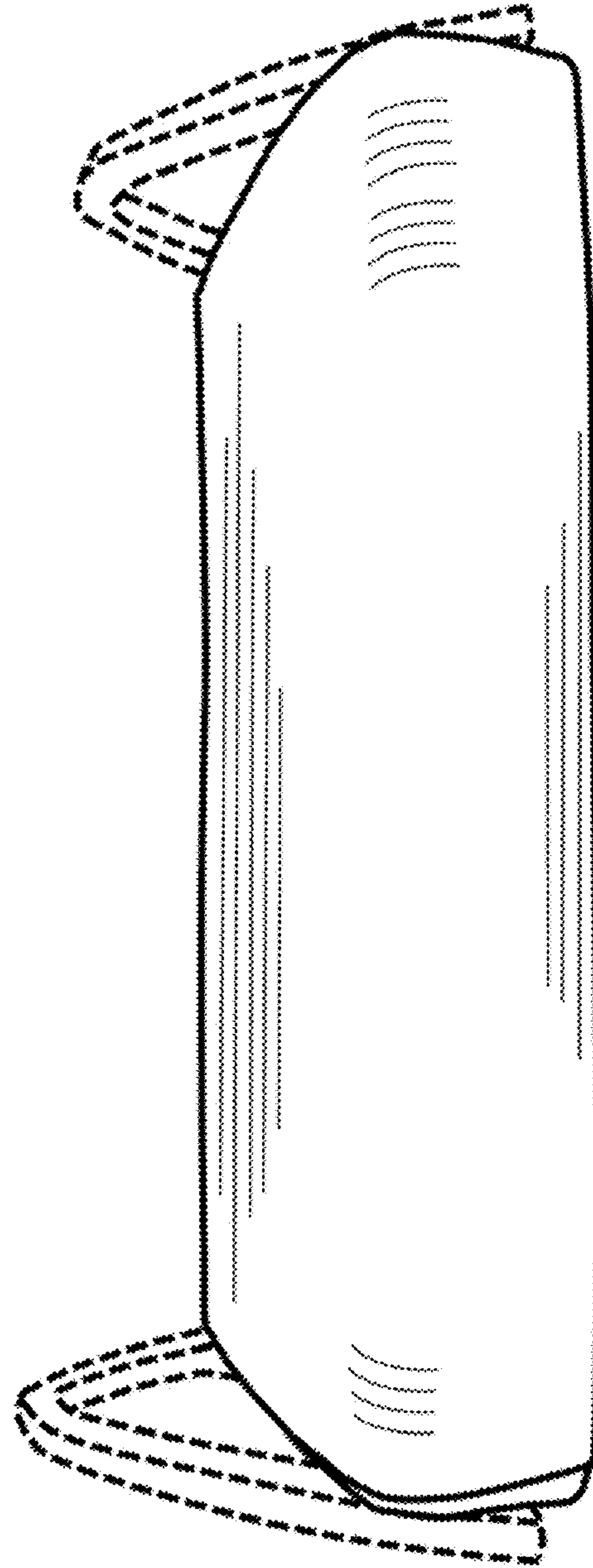

FIG. 4

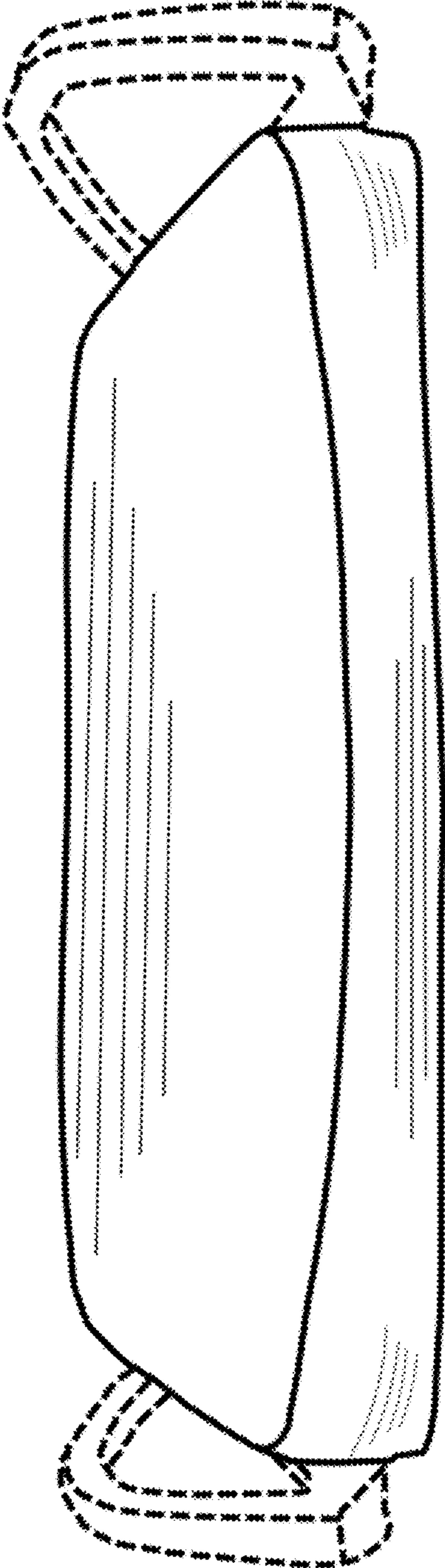

FIG. 5

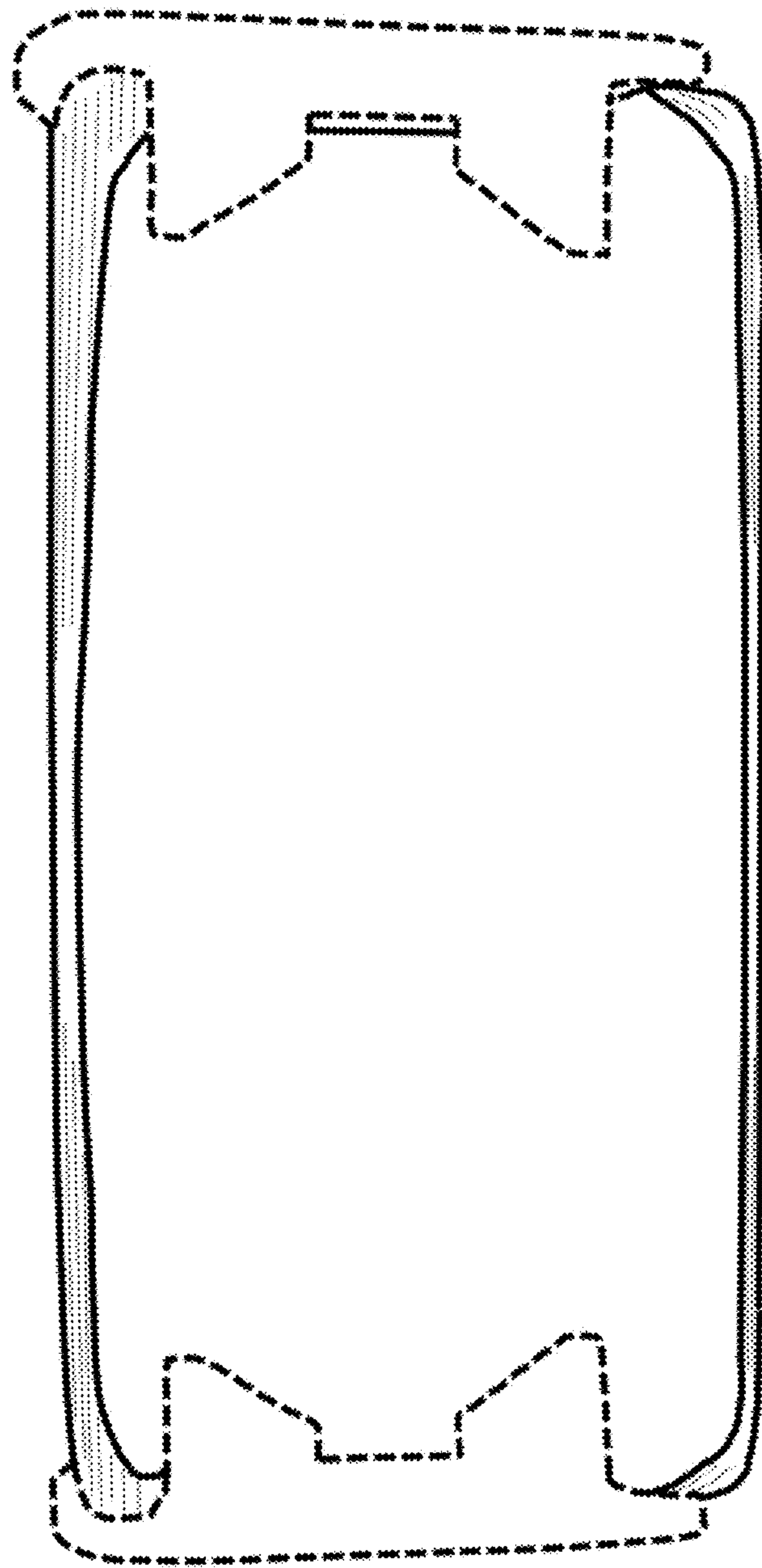

FIG. 6

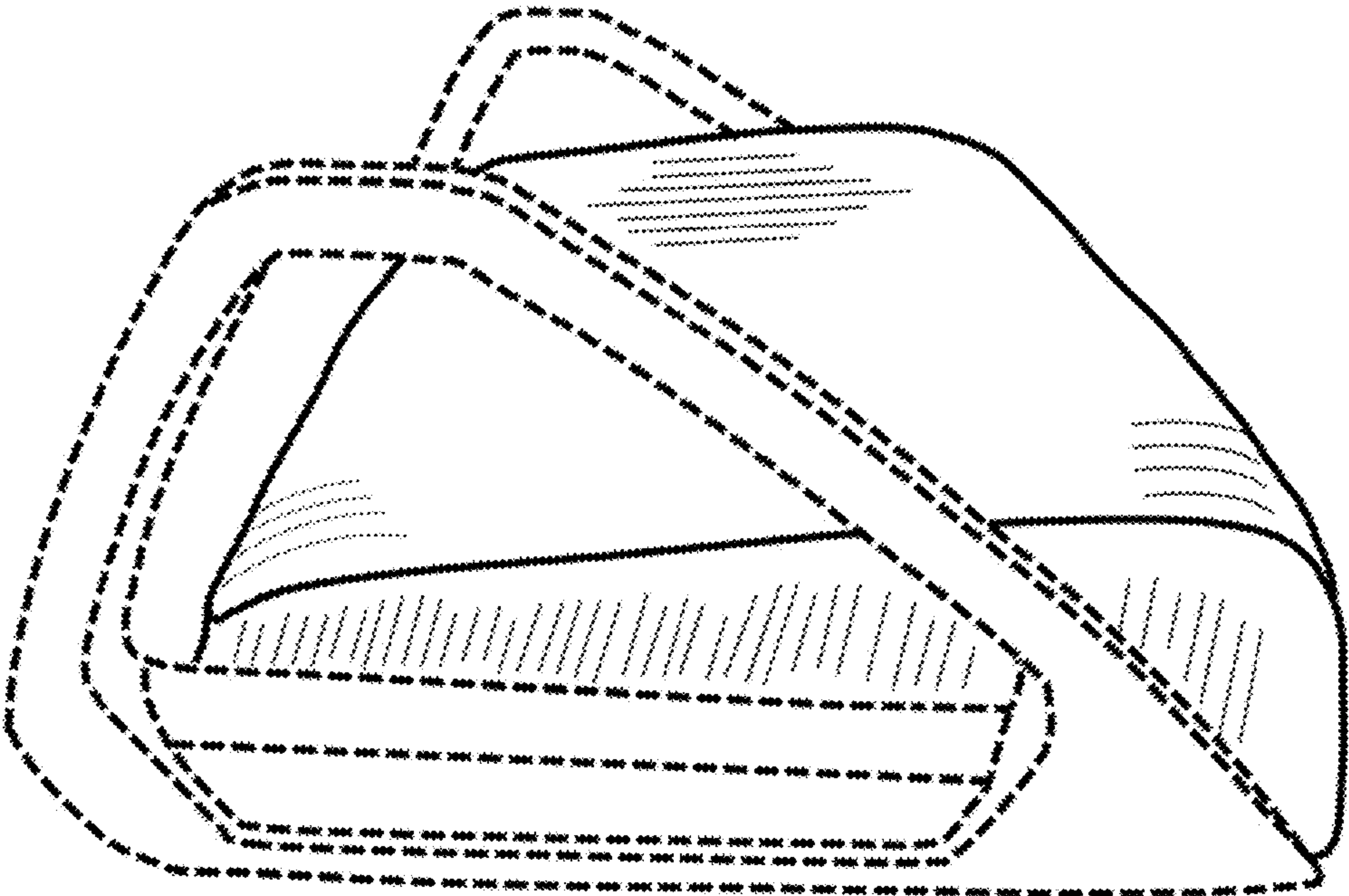

FIG. 7

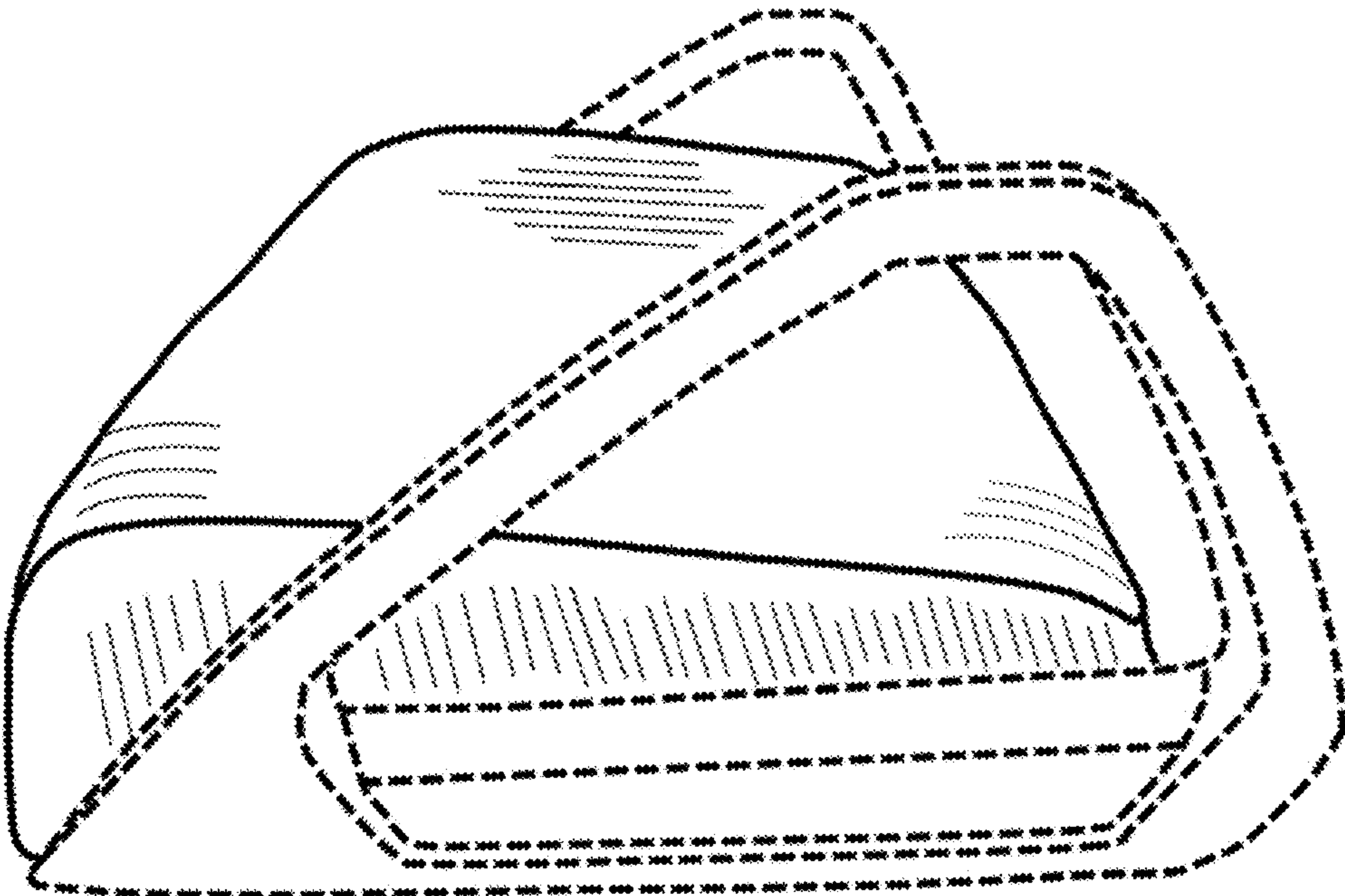

FIG. 8

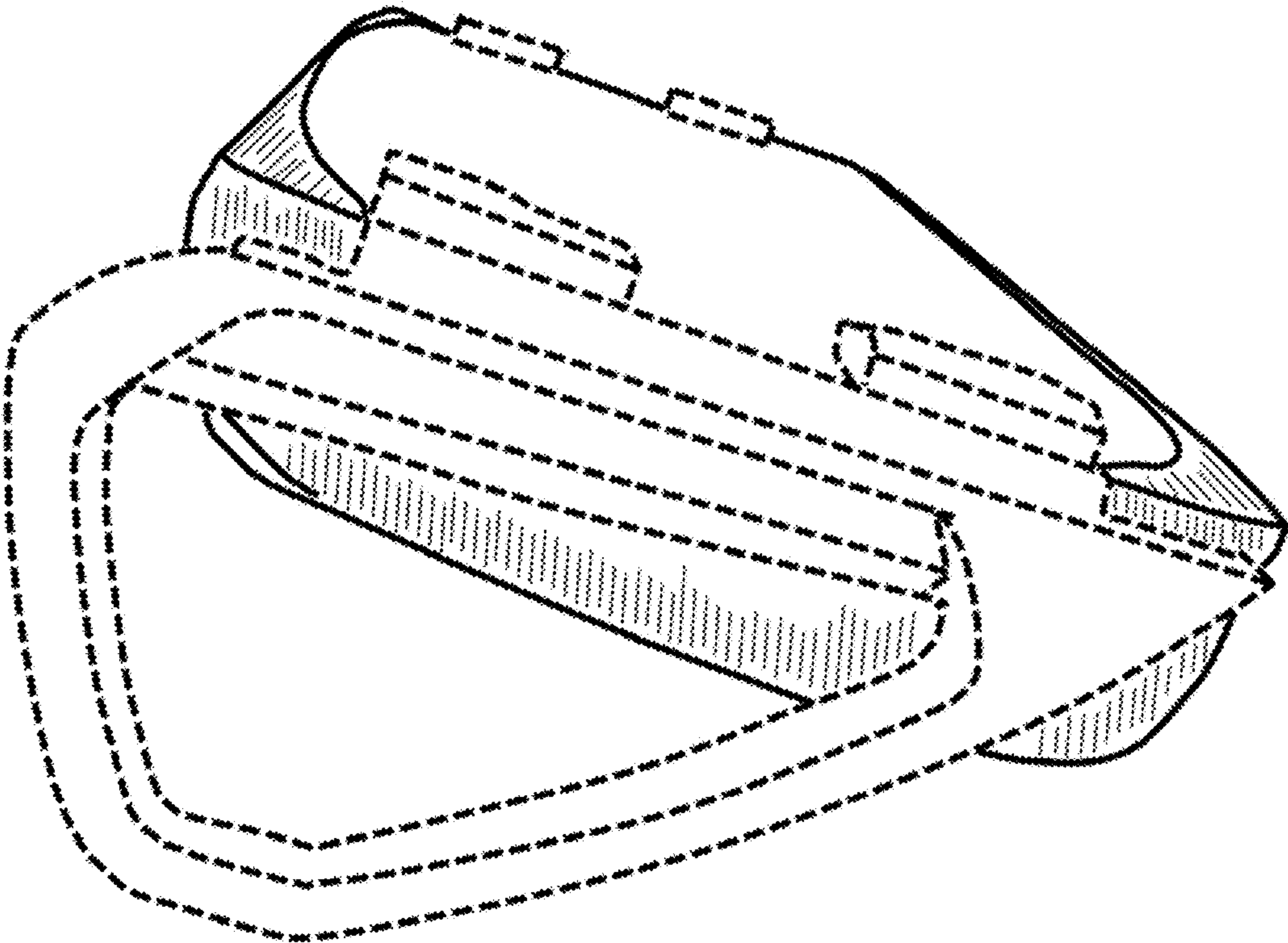

FIG. 9

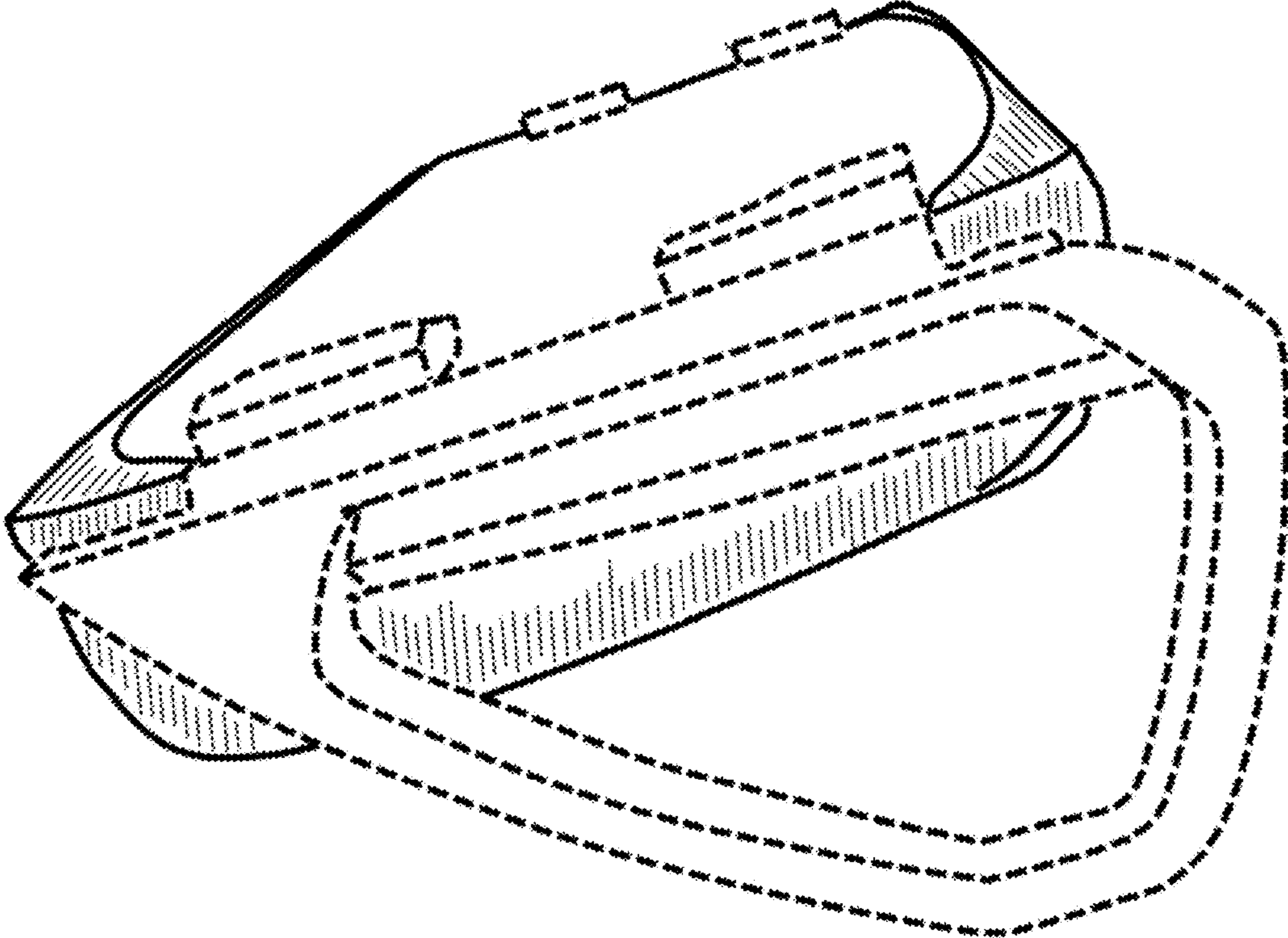

FIG. 10

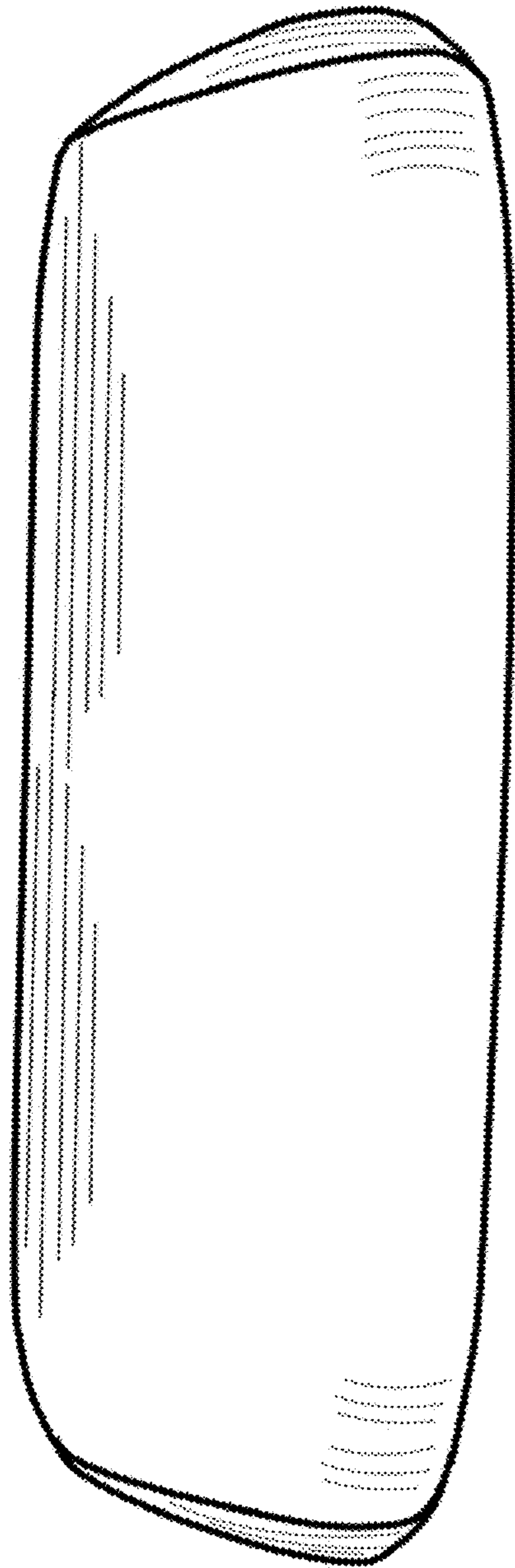

FIG. 11

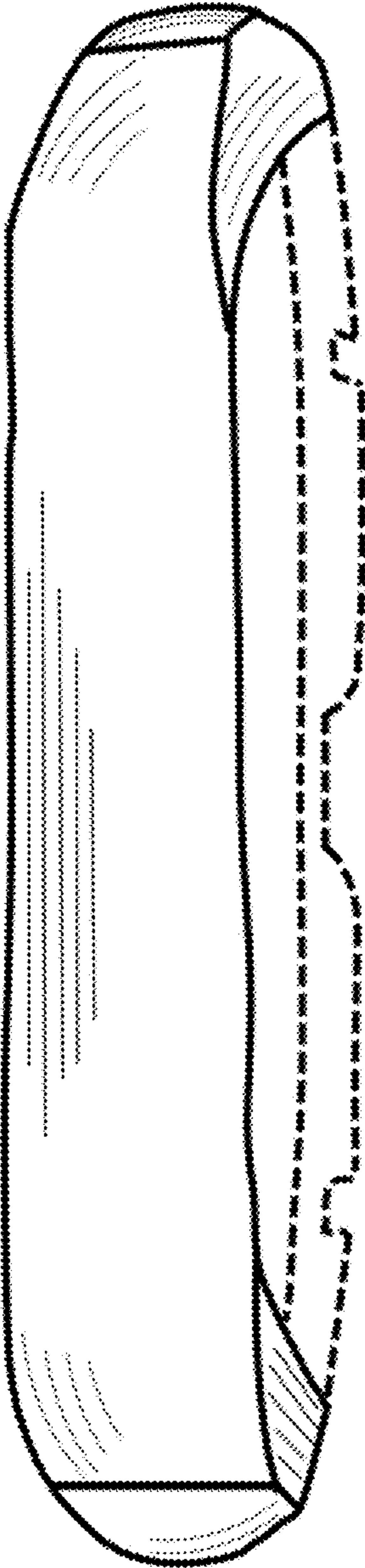

FIG. 12

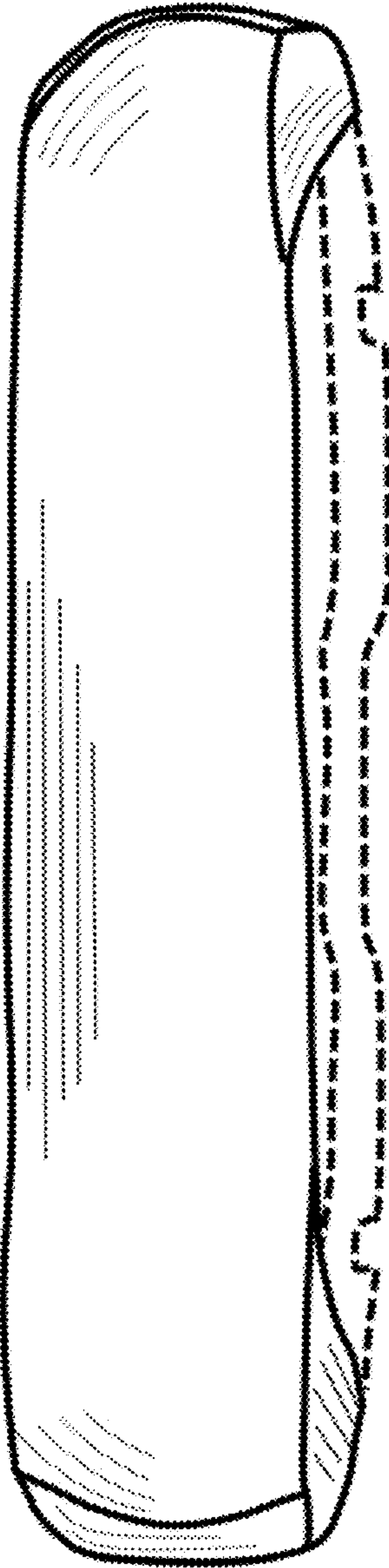

FIG. 13

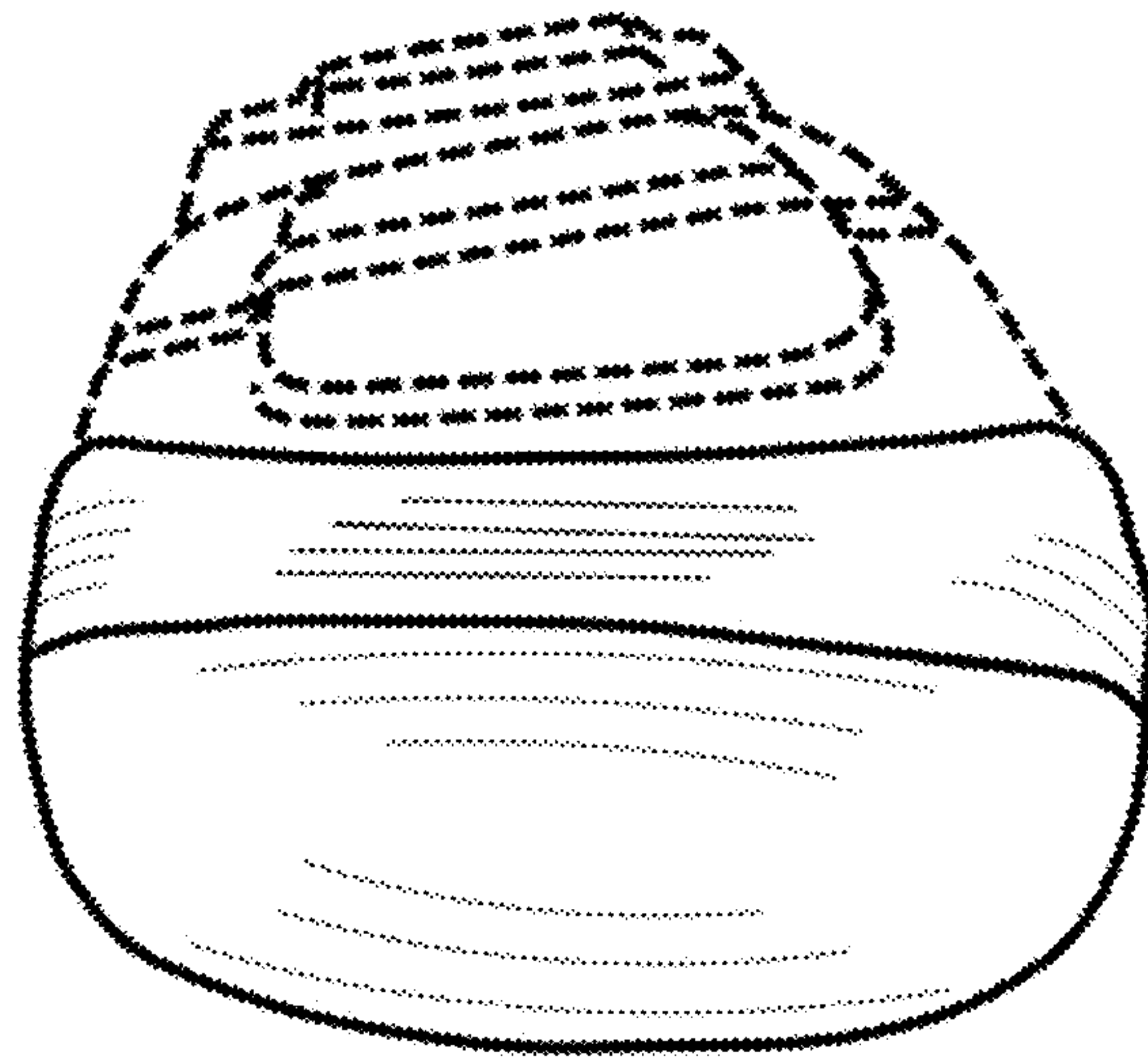

FIG. 14

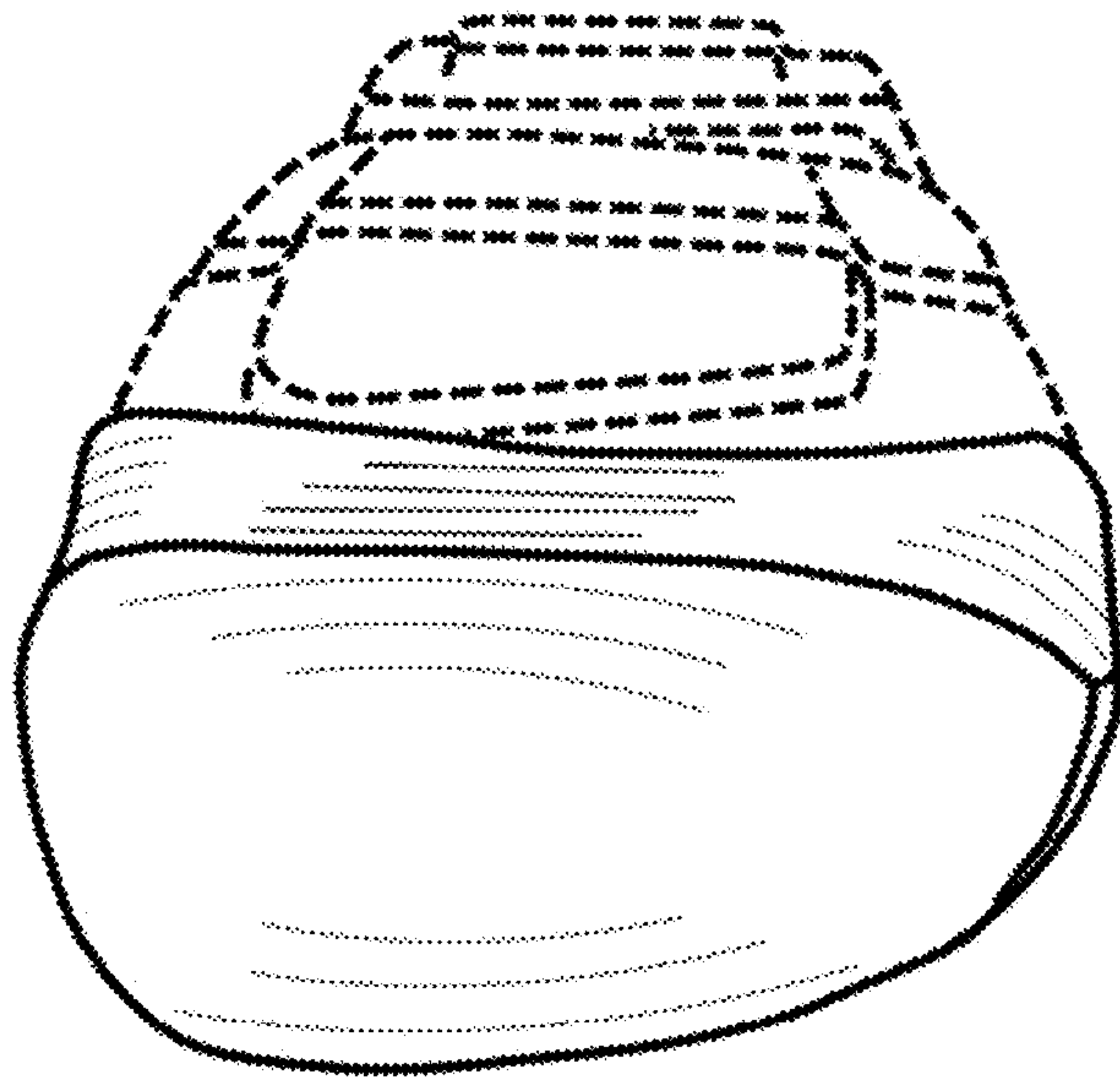

FIG. 15

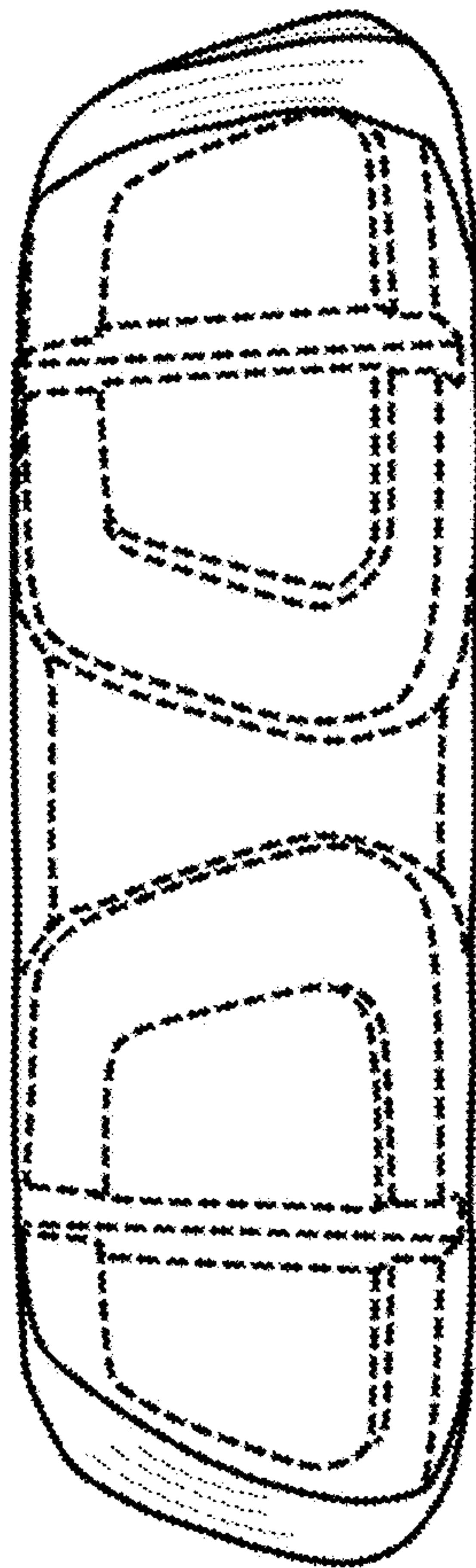

FIG. 16