



US00D806388S

(12) **United States Design Patent** (10) **Patent No.:** **US D806,388 S**
Akana et al. (45) **Date of Patent:** **** Jan. 2, 2018**

(54) **CASE**

(71) Applicant: **Apple Inc.**, Cupertino, CA (US)

(72) Inventors: **Jody Akana**, San Francisco, CA (US);
Molly Anderson, San Francisco, CA (US); **Bartley K. Andre**, Palo Alto, CA (US); **Shota Aoyagi**, San Francisco, CA (US); **Anthony Michael Ashcroft**, San Francisco, CA (US); **Marine C. Bataille**, San Francisco, CA (US); **Jeremy Bataillou**, San Francisco, CA (US); **Daniel J. Coster**, San Francisco, CA (US); **Daniele De Iuliis**, San Francisco, CA (US); **Markus Diebel**, San Francisco, CA (US); **M. Evans Hankey**, San Francisco, CA (US); **Julian Hoenig**, San Francisco, CA (US); **Richard P. Howarth**, San Francisco, CA (US); **Jonathan P. Ive**, San Francisco, CA (US); **Julian Jaede**, San Francisco, CA (US); **Duncan Robert Kerr**, San Francisco, CA (US); **Peter Russell-Clarke**, San Francisco, CA (US); **Benjamin Andrew Shaffer**, San Jose, CA (US); **Mikael Silvano**, San Francisco, CA (US); **Christopher J. Stringer**, Woodside, CA (US); **Sung-Ho Tan**, San Francisco, CA (US); **Clement Tissandier**, San Francisco, CA (US); **Eugene Antony Whang**, San Francisco, CA (US); **Rico Zörkendörfer**, San Francisco, CA (US)

(73) Assignee: **Apple Inc.**, Cupertino, CA (US)

(**) Term: **15 Years**

(21) Appl. No.: **29/576,707**

(22) Filed: **Sep. 6, 2016**

(51) **LOC (11) Cl.** **03-01**

(52) **U.S. Cl.**
USPC **D3/294**

(58) **Field of Classification Search**

USPC D9/516, 521, 523, 529, 549, 565, 571,
D9/400, 423, 424, 446, 449; D28/73, 76,
(Continued)

(56) **References Cited**

U.S. PATENT DOCUMENTS

228,598 A * 6/1880 Buckley 206/266
3,246,815 A * 4/1966 Aronson A61C 15/043
225/44

(Continued)

OTHER PUBLICATIONS

Apple AirPods wireless headphones review, available Sep. 13, 2016, [online], [site visited Oct. 12, 2017]. Video available from internet, < URL: https://www.youtube.com/watch?v=wQ5Gj0UB_R8 (Year: 2016).*

(Continued)

Primary Examiner — Cathron C Brooks

Assistant Examiner — W. A. Teddy Falloway

(74) *Attorney, Agent, or Firm* — Sterne, Kessler, Goldstein & Fox P.L.L.C.

(57) **CLAIM**

The ornamental design for a case, as shown and described.

DESCRIPTION

FIG. 1 is a top front perspective view of a case in a closed position showing the claimed design;

FIG. 2 is a front view thereof;

FIG. 3 is a rear view thereof;

FIG. 4 is a left side view thereof;

FIG. 5 is a right side view thereof;

FIG. 6 is a top view thereof;

FIG. 7 is a bottom view thereof;

FIG. 8 is a top front perspective view thereof in an open position;

FIG. 9 is a front view thereof;

FIG. 10 is a rear view thereof;

(Continued)

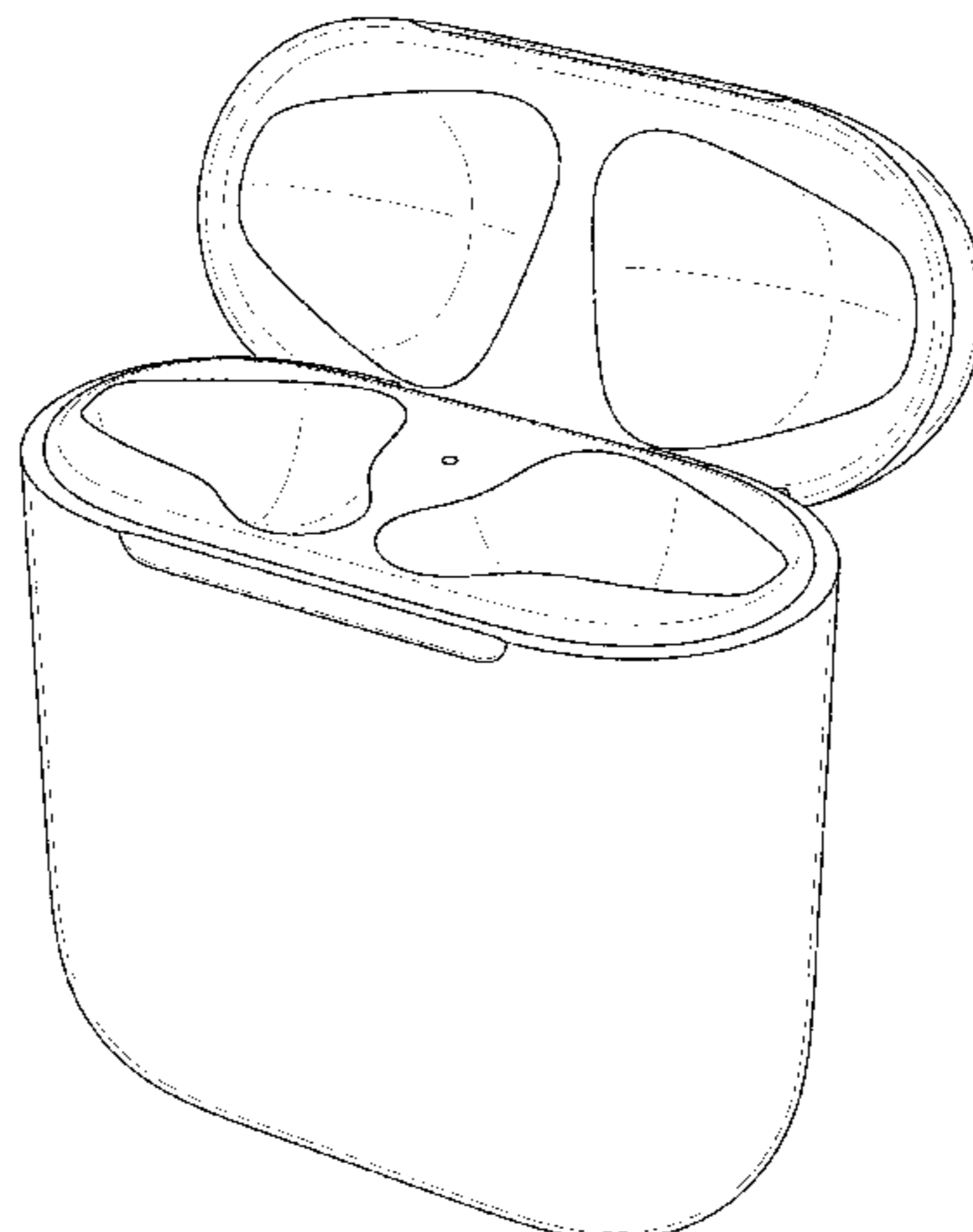

FIG. 11 is a left side view thereof;
 FIG. 12 is a right side view thereof;
 FIG. 13 is a top view thereof;
 FIG. 14 is a bottom view thereof;
 FIG. 15 is a cross-sectional view thereof taken along line 15-15 in FIG. 13; and,
 FIG. 16 is a top front perspective view thereof in an environment in which it may be used.
 The broken lines in the figures show portions of the case and environment that form no part of the claimed design.
 The cross-hatching in FIG. 15 forms no part of the claimed design.

D637,647	S	*	5/2011	Allison	D19/73
D651,903	S	*	1/2012	Teller	D9/521
D672,642	S	*	12/2012	Supranowicz	D9/420
D681,015	S		4/2013	Akana et al.		
D683,902	S	*	6/2013	Zotalis	D28/76
D691,594	S		10/2013	Akana et al.		
D706,643	S		6/2014	Akana et al.		
8,739,967	B1	*	6/2014	George	A24F 15/18 131/242
D708,784	S	*	7/2014	Kim	D28/7
D720,096	S	*	12/2014	McDougall	D28/66
D740,653	S		10/2015	Akana et al.		
D775,960	S	*	1/2017	Erdwiens	D9/521
2017/0094399	A1	*	3/2017	Chandramohan	A45C 13/02
2017/0245038	A1	*	8/2017	Chawan	H04R 1/1016

1 Claim, 15 Drawing Sheets

(58) **Field of Classification Search**
 USPC D28/78; D3/247, 265, 269; 206/528,
 206/811, 822, 242, 285, 38
 CPC A45C 2011/001; A45C 13/005; A61C
 15/043
 See application file for complete search history.

(56) **References Cited**

U.S. PATENT DOCUMENTS

D281,281	S	*	11/1985	Matalon	D28/5
D310,480	S	*	9/1990	Geiger	D9/529
D322,752	S	*	12/1991	Zintzmeyer	D4/116
D339,215	S	*	9/1993	Spencer, Jr.	D28/66
D342,676	S	*	12/1993	Wuttke	D9/443
D356,828	S	*	3/1995	Harris	D19/65
D364,708	S	*	11/1995	Tarrson	D28/66
D367,608	S	*	3/1996	Stranders	D9/529
D380,355	S	*	7/1997	Husted	D7/679
D399,604	S	*	10/1998	Wolff	D28/66
D422,139	S	*	4/2000	Meikle	D3/263
D436,434	S	*	1/2001	Conway	D3/203.5
D463,907	S	*	10/2002	Lemoine	D3/205
D464,941	S	*	10/2002	Latto	D14/203.3
D467,799	S	*	12/2002	Persson	D9/420
D475,282	S	*	6/2003	Snaith	D28/66
D478,546	S	*	8/2003	Andre	D13/110
D479,823	S	*	9/2003	Andre	D13/110
D482,618	S	*	11/2003	Cummings	D9/529
D493,257	S	*	7/2004	McCorkindale	D28/66
D506,744	S		6/2005	Andre et al.		
D510,029	S	*	9/2005	Marcot	D9/529
D528,012	S	*	9/2006	Snyder	D9/529
D532,695	S	*	11/2006	Grant	D9/521
D541,173	S	*	4/2007	Karussi	D9/734
D542,664	S	*	5/2007	Mayers	D9/529
D576,037	S	*	9/2008	Beam	D9/435
D616,738	S	*	6/2010	Andre	D9/430

OTHER PUBLICATIONS

“Review: Hush smart earplugs put a waterfall in your ear”, available May 11, 2016, [online], [site visited Oct. 12, 2017]. Available from internet, <URL: <https://newatlas.com/hush-smart-earplug-review/43272/> (Year: 2016).*

Johnson & Johnson Reach Dental Floss, available Aug. 15, 2008, [online], [site visited Oct. 12, 2017]. Available from internet, <URL: <https://www.amazon.co.uk/Johnsons-Johnson-Reach-Dental-Floss/dp/B001ECQSHW> (Year: 2008).*

Tom’s of Maine Natural Waxed Antiplaque Flat Floss, available 2017, [online], [site visited Oct. 12, 2017]. Available from internet, < URL: <http://www.dentalsreview.com/best-dental-floss-review/> (Year: 2017).*

Oral-B Glide Pro-Health Deep Clean Floss, available 2017, [online], [site visited Oct. 12, 2017]. Available from internet, <URL: <http://www.dentalsreview.com/best-dental-floss-review/> (Year: 2017).*

“Spheres, equations and terminology” (written by Paul Bourke), Apr. 1992, [online], [site visited Oct. 13, 2017]. Available from internet, < URL: <http://paulbourke.net/geometry/circlesphere/> (Year: 1992).*

Round corners for Openscad—Tutorial (written by William A Adams), Jun. 15, 2011, [online], [site visited Oct. 13, 2017]. Available from internet, <URL: <https://www.thingiverse.com/thing:9347> (Year: 2011).*

“Samsung’s stylish mobile accessories are launching worldwide” (via engadget), Oct. 31, 2016, [online], [site visited Oct. 13, 2017]. Available from internet, <URL: <https://www.engadget.com/2016/10/31/samsung-stylish-mobile-accessories/#/> (Year: 2016).*

Veho Pebble Explorer Portable Power Bank, Mar. 17, 2014, [online], [site visited Oct. 13, 2017]. Available from internet, <URL: https://www.amazon.com/gp/product/B00FS6YQWY/ref=as_li_tl?tag=travelfcom0a-20&ie=UTF8&camp=1789&creative=390957&creativeASIN=B00FS6YQWY&linkCode=as2&linkId=RXUJDO2BX2CNJTUK (Year: 2014).*

* cited by examiner

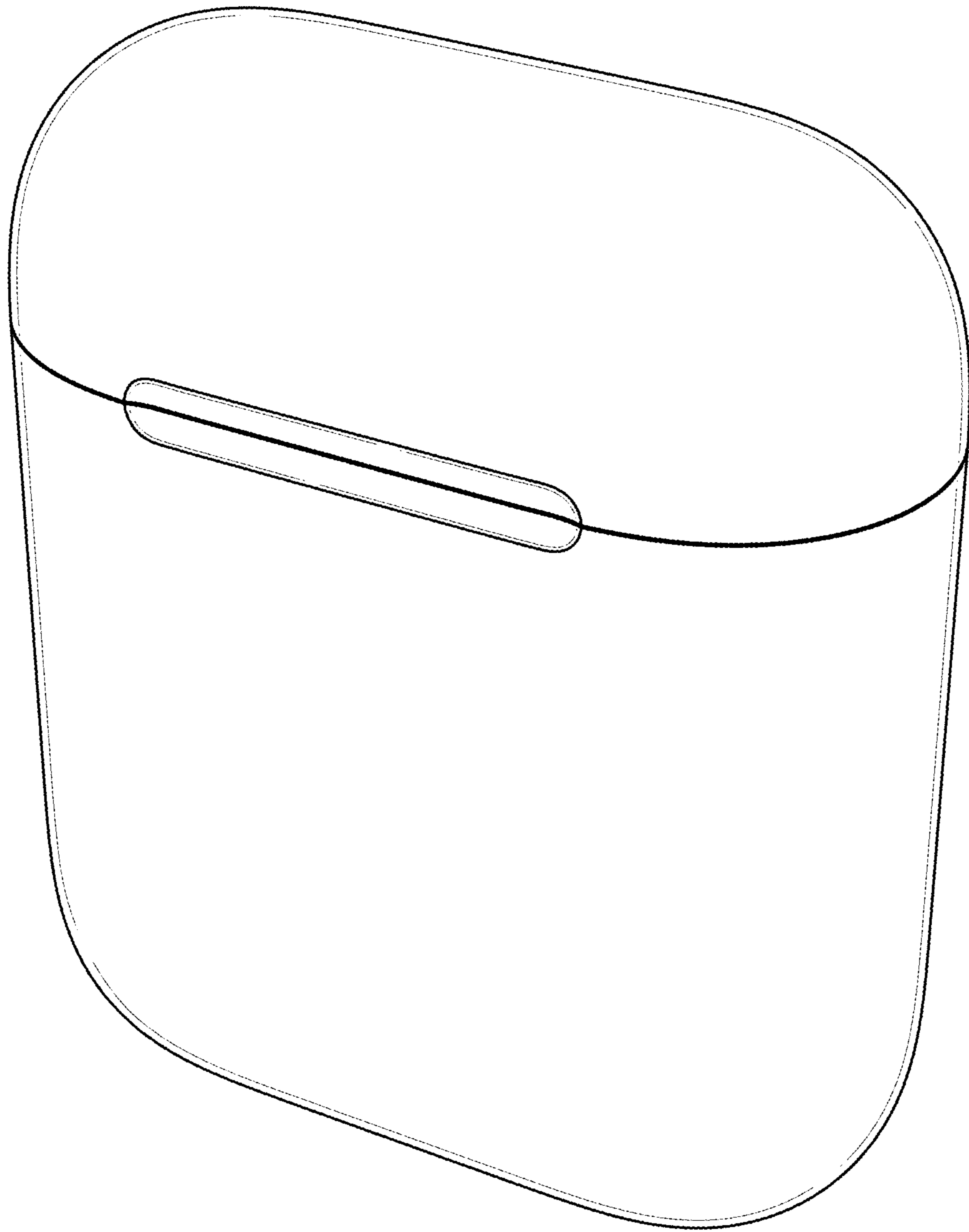

FIG. 1

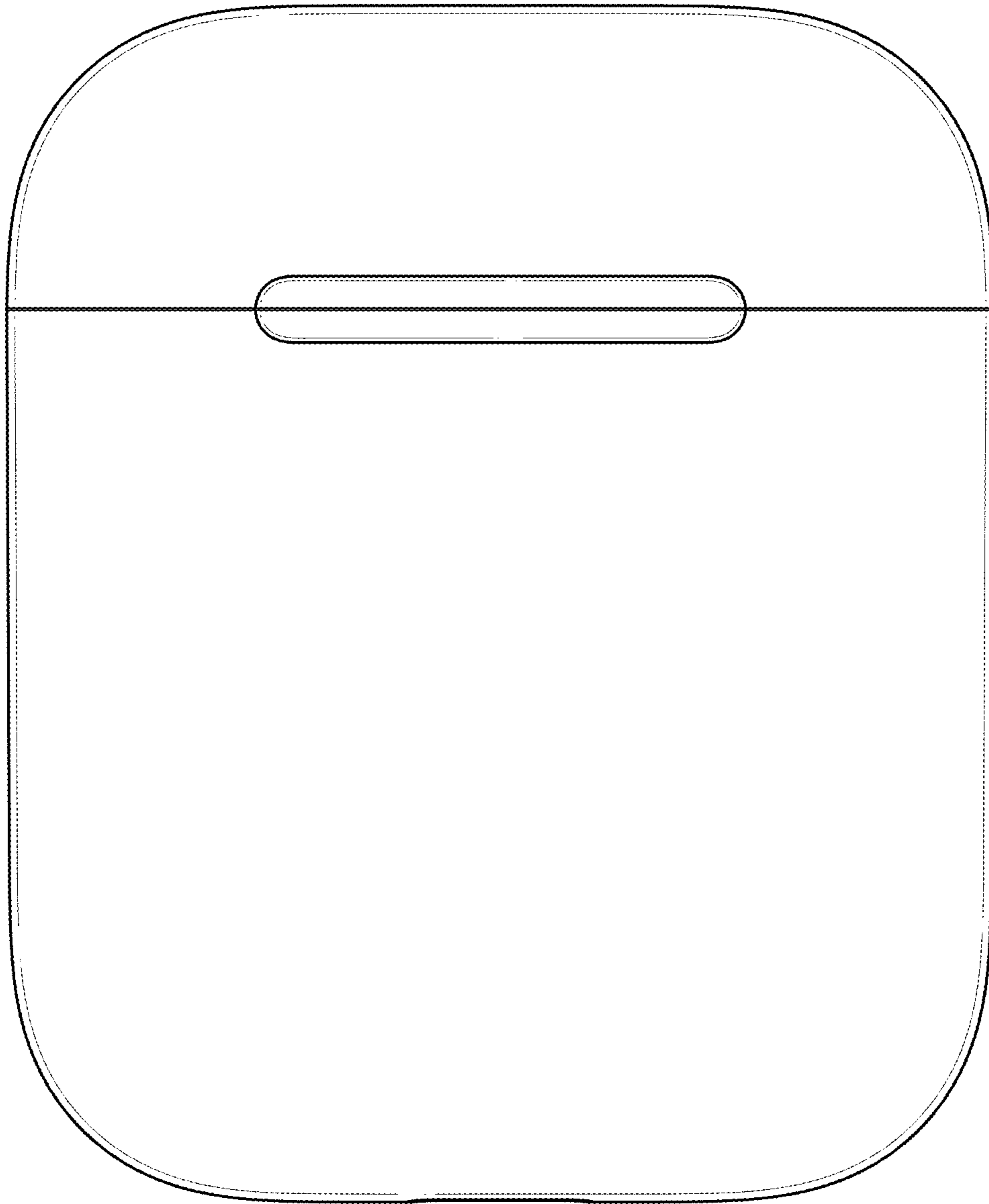

FIG. 2

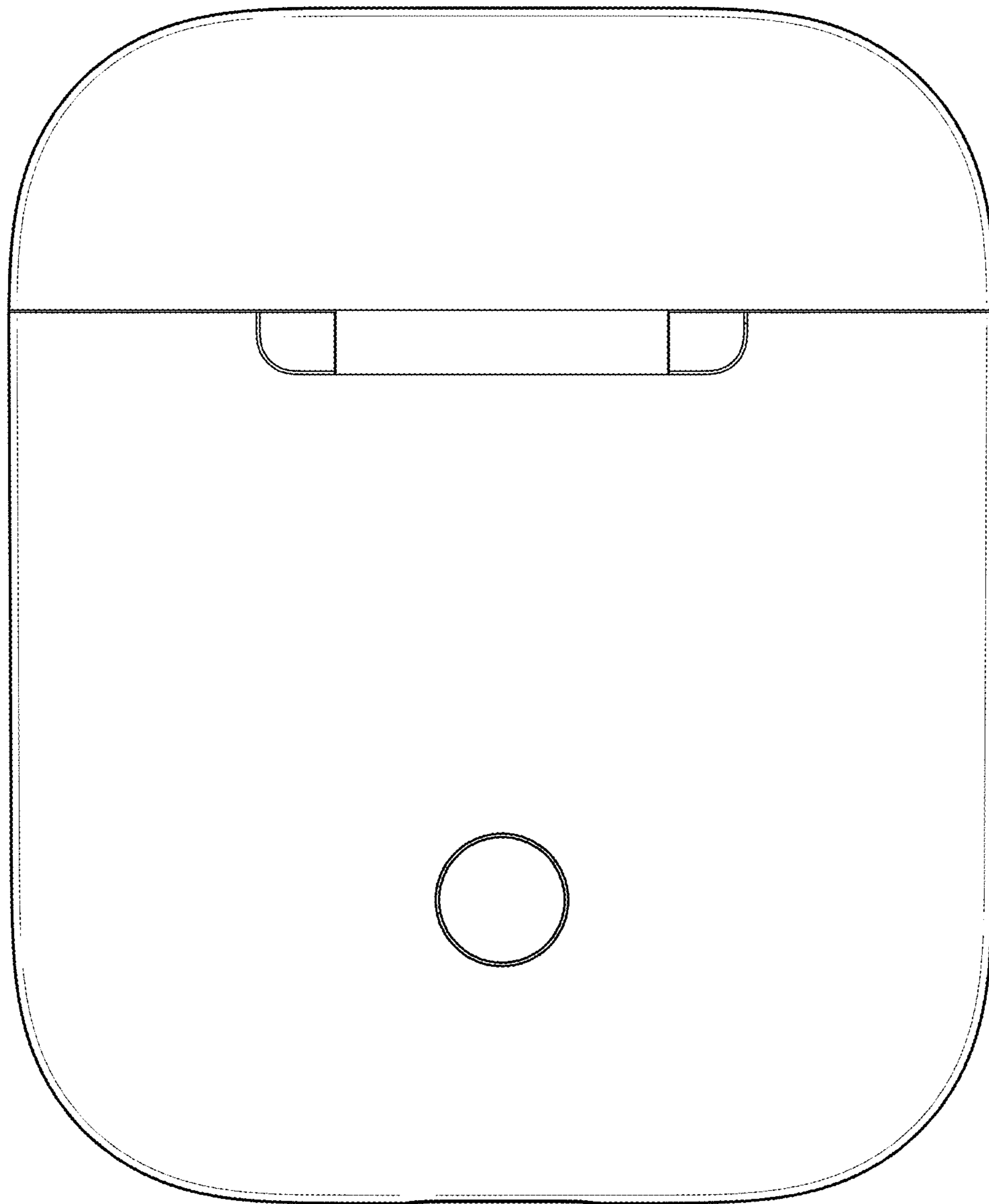

FIG. 3

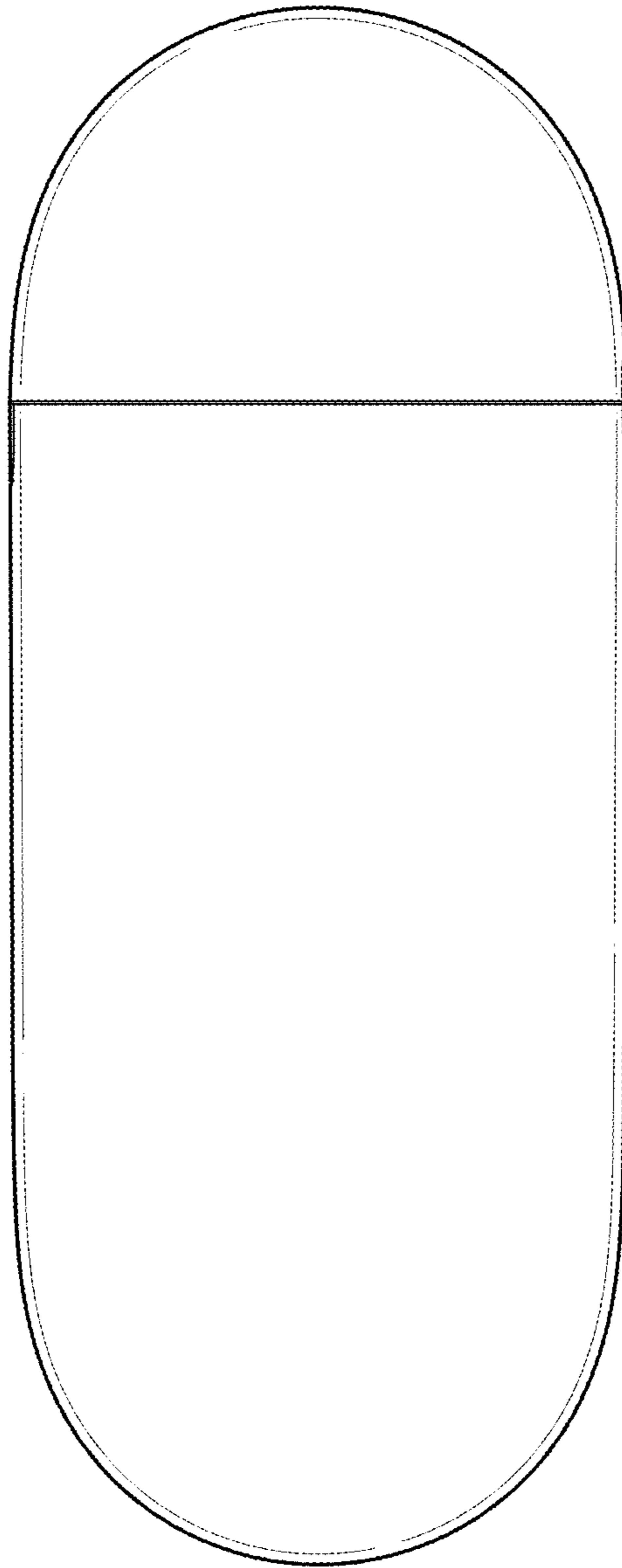

FIG. 4

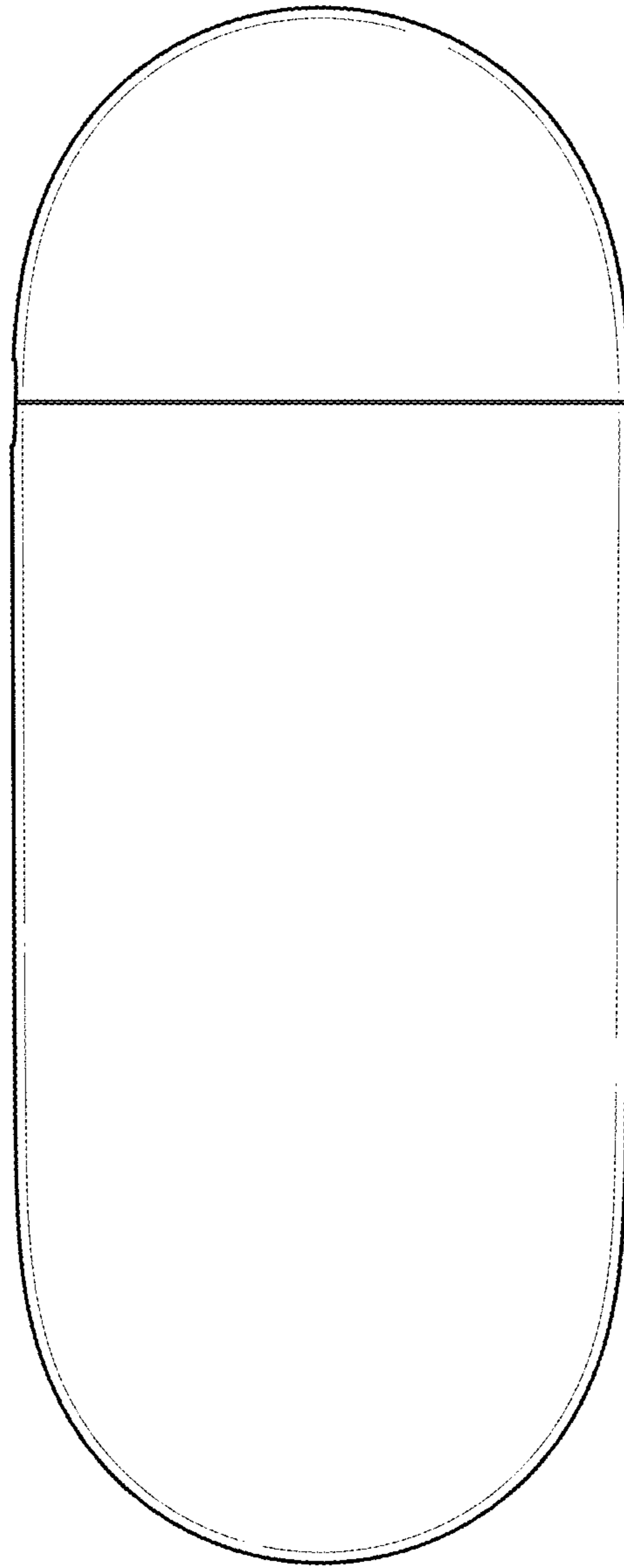

FIG. 5

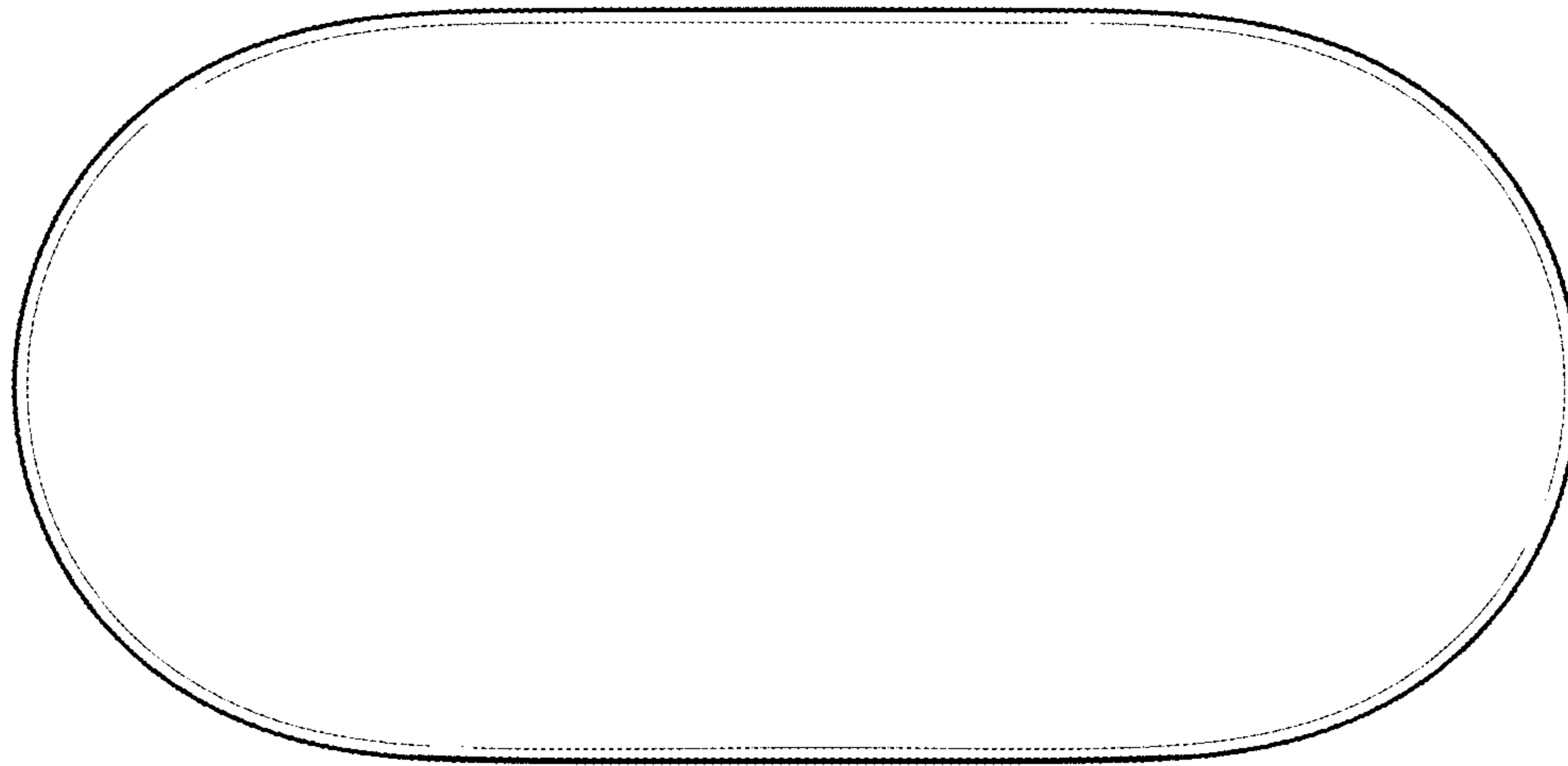

FIG. 6

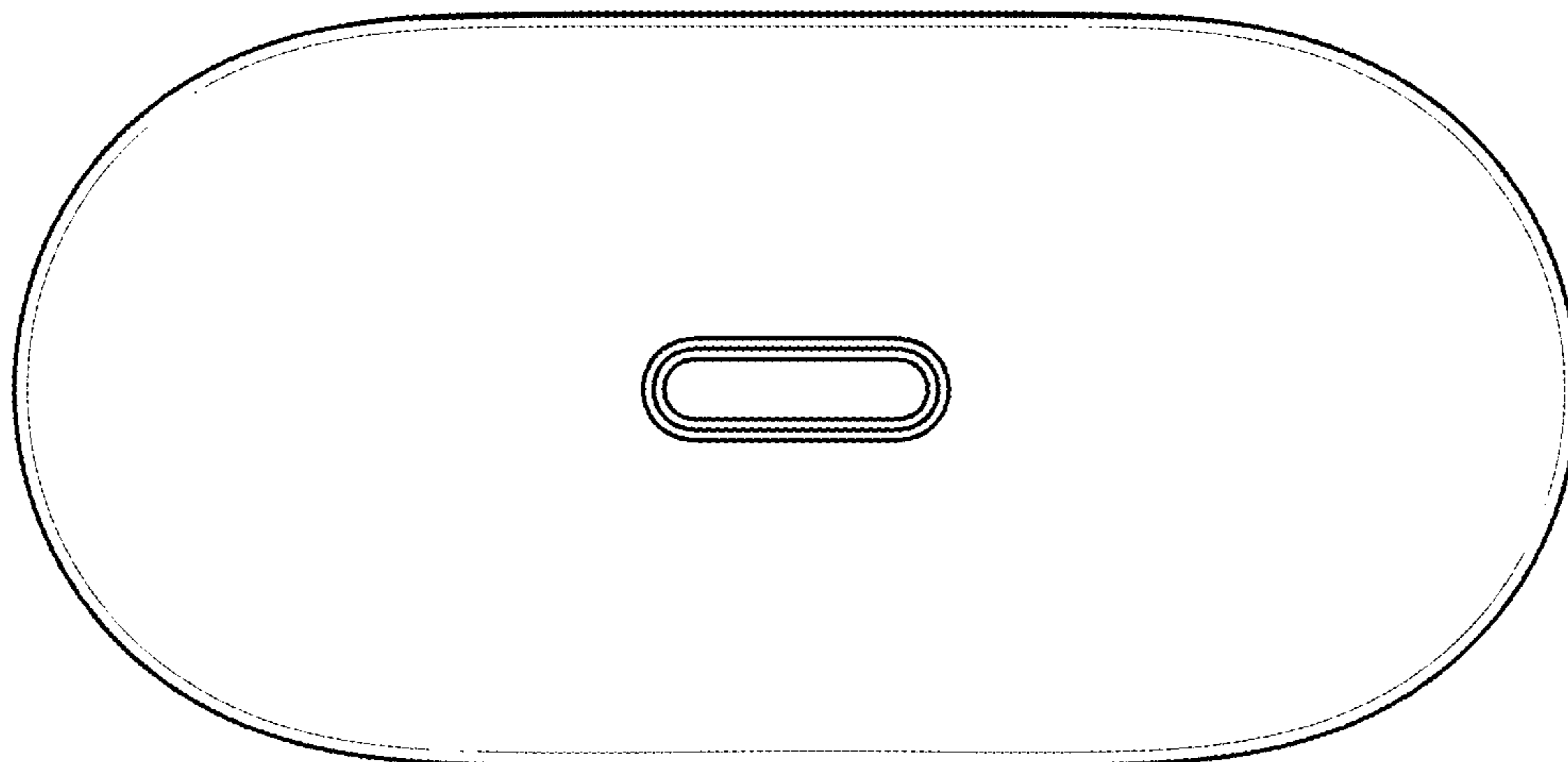

FIG. 7

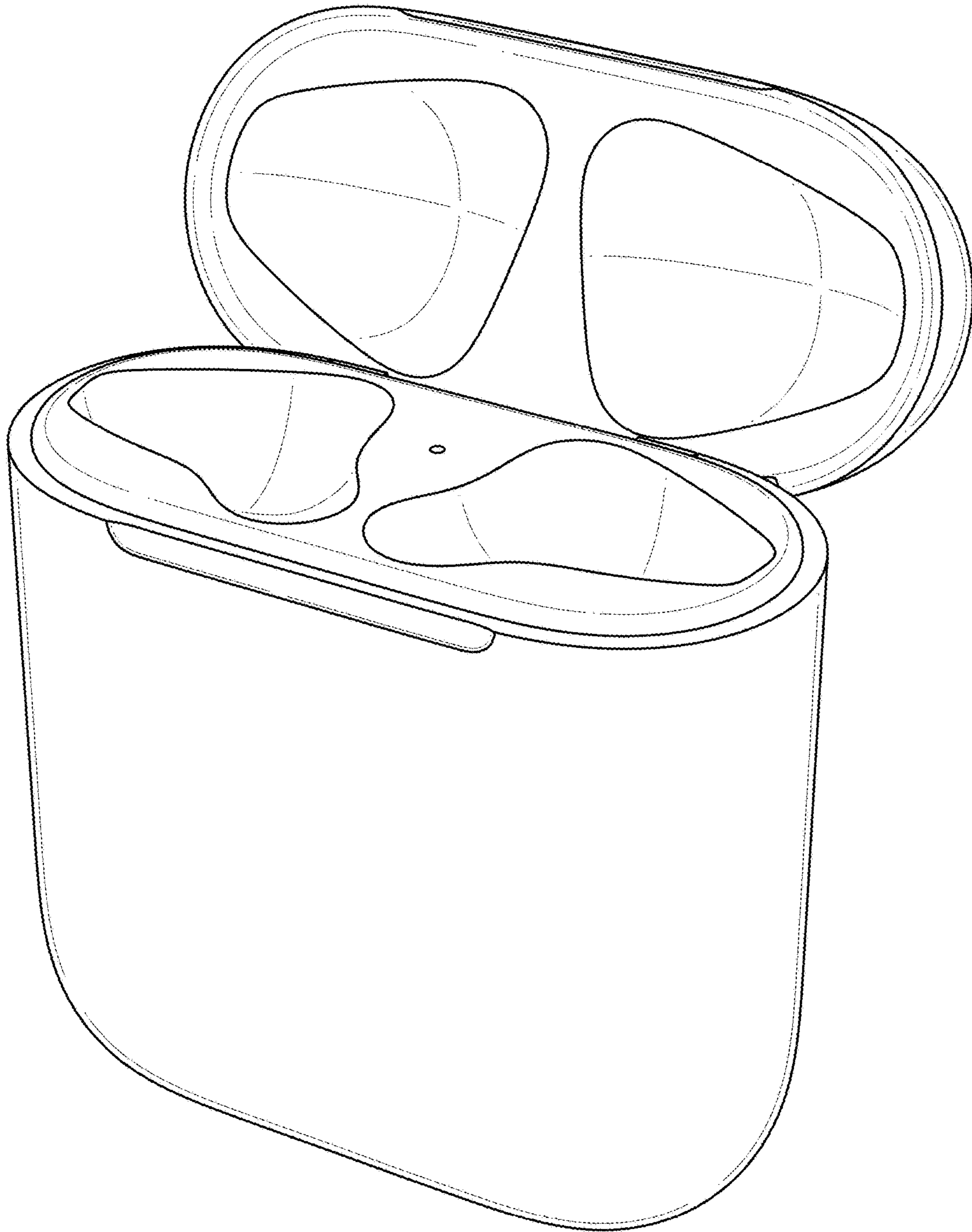

FIG. 8

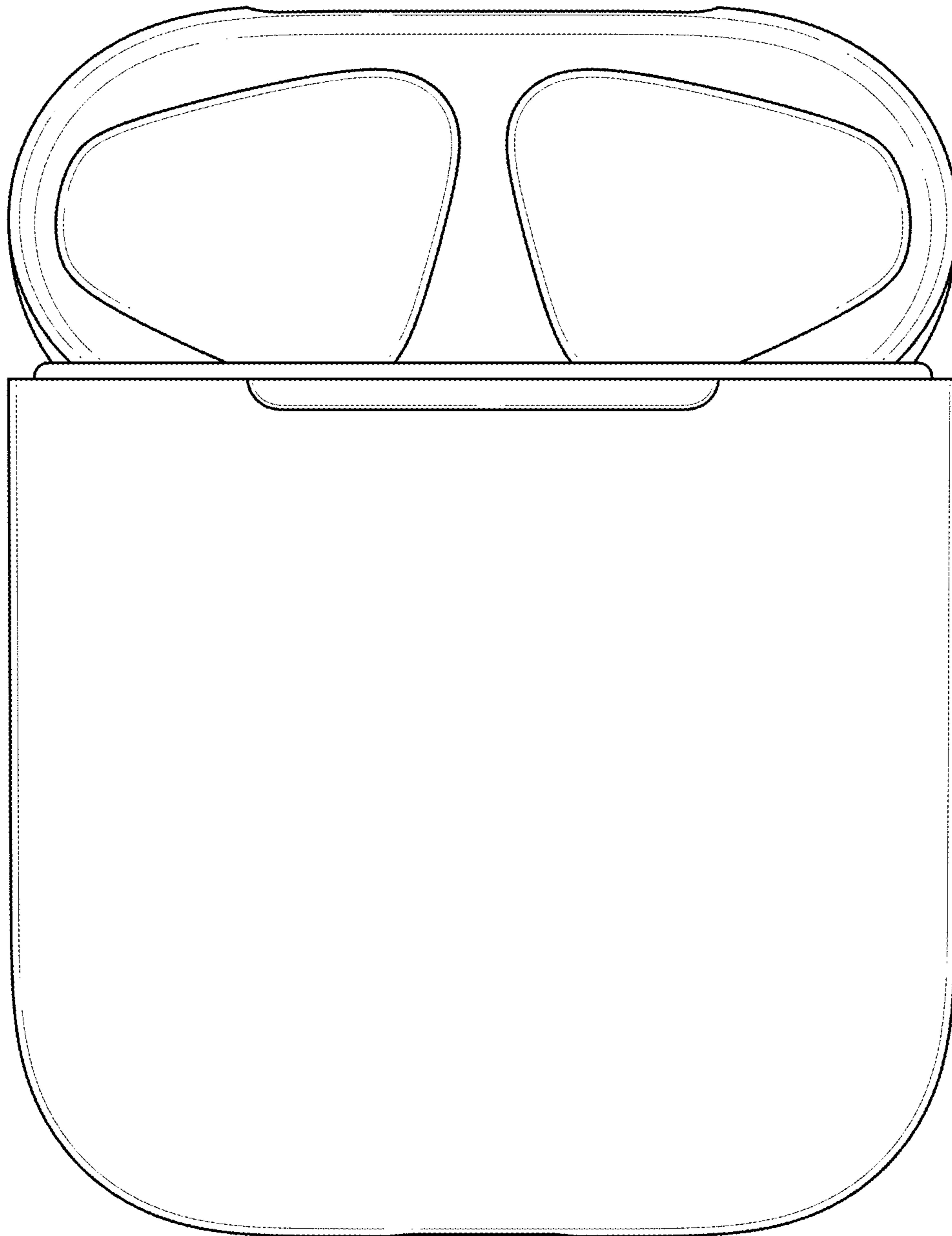

FIG. 9

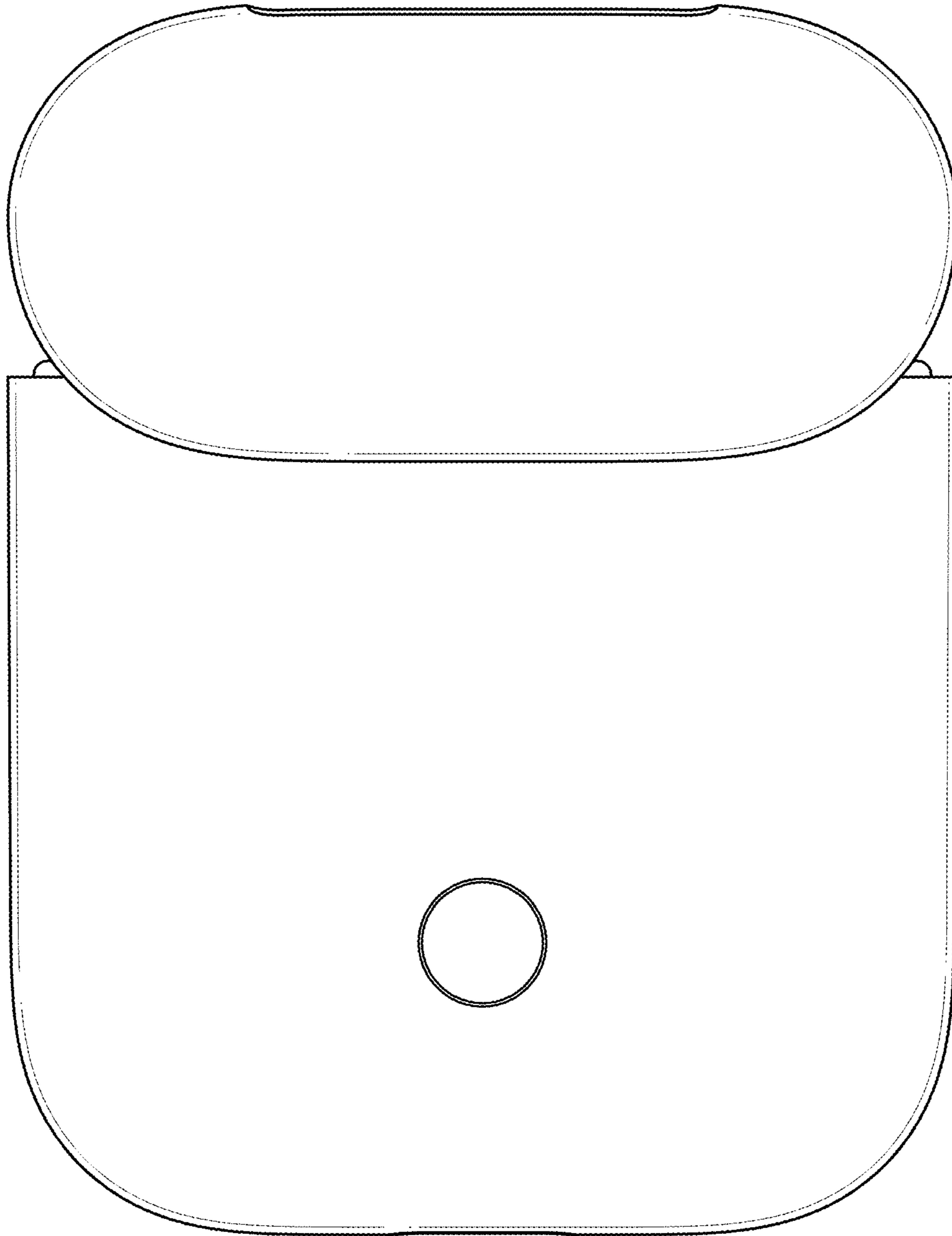

FIG. 10

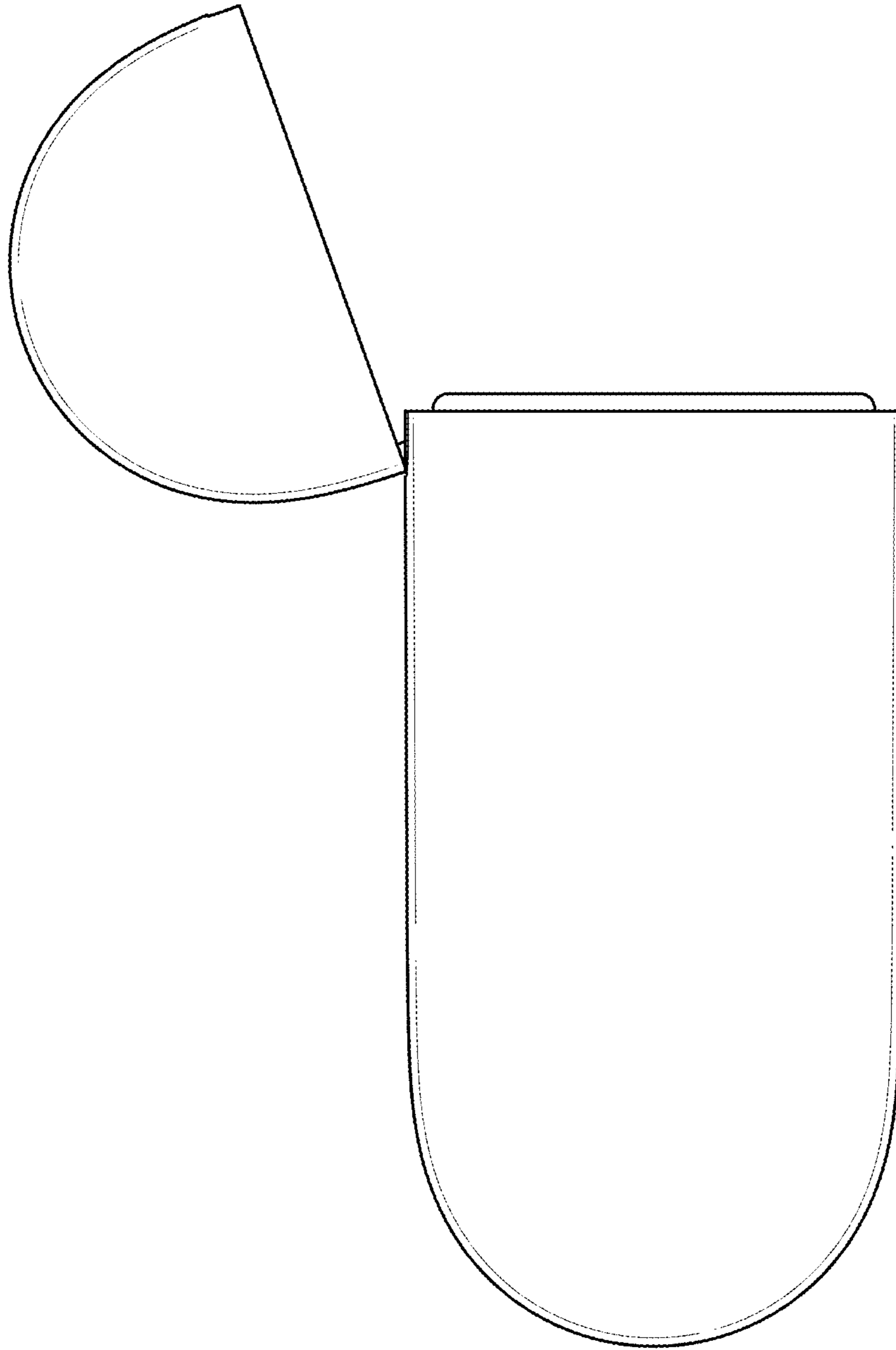

FIG. 11

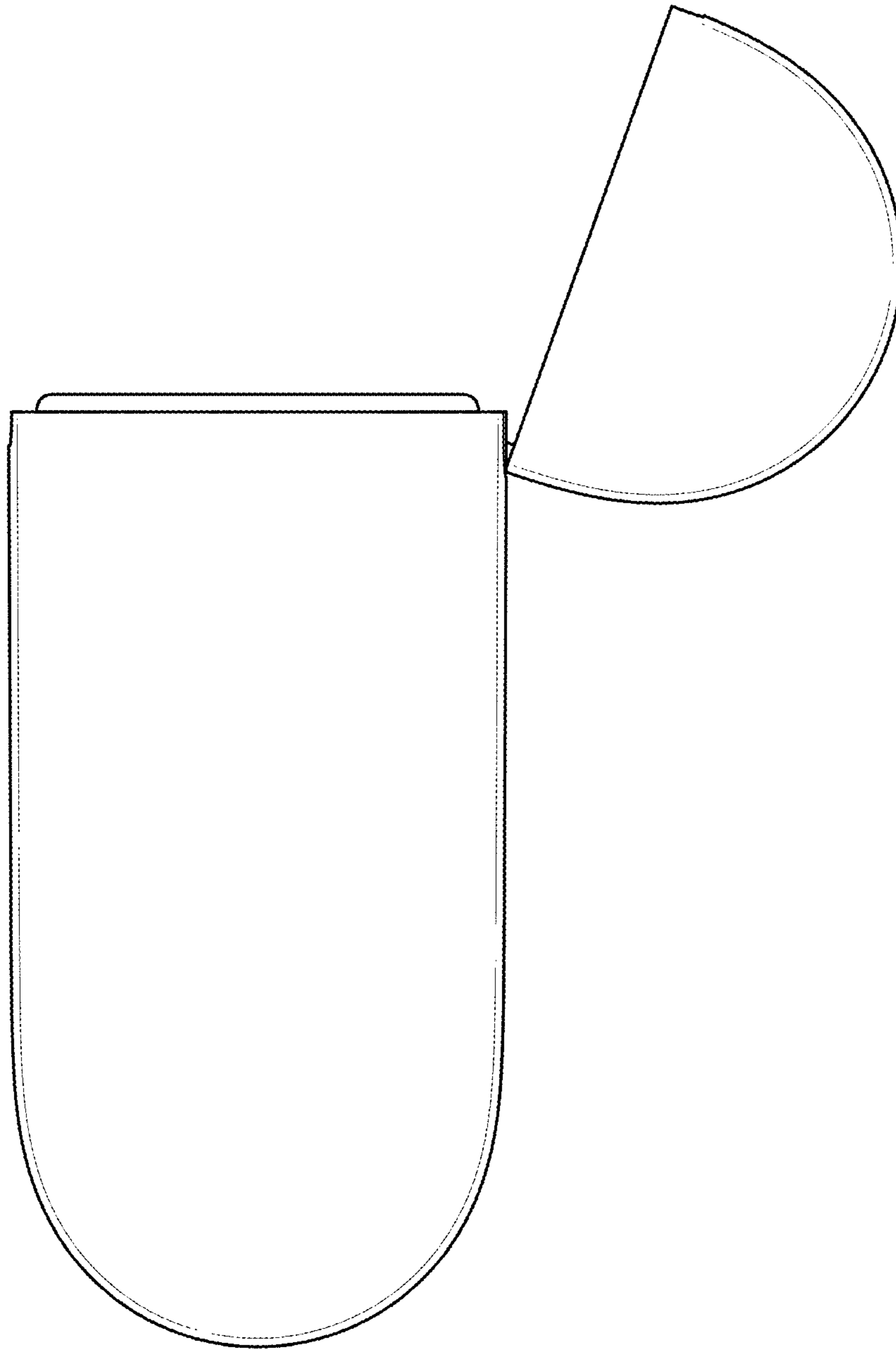

FIG. 12

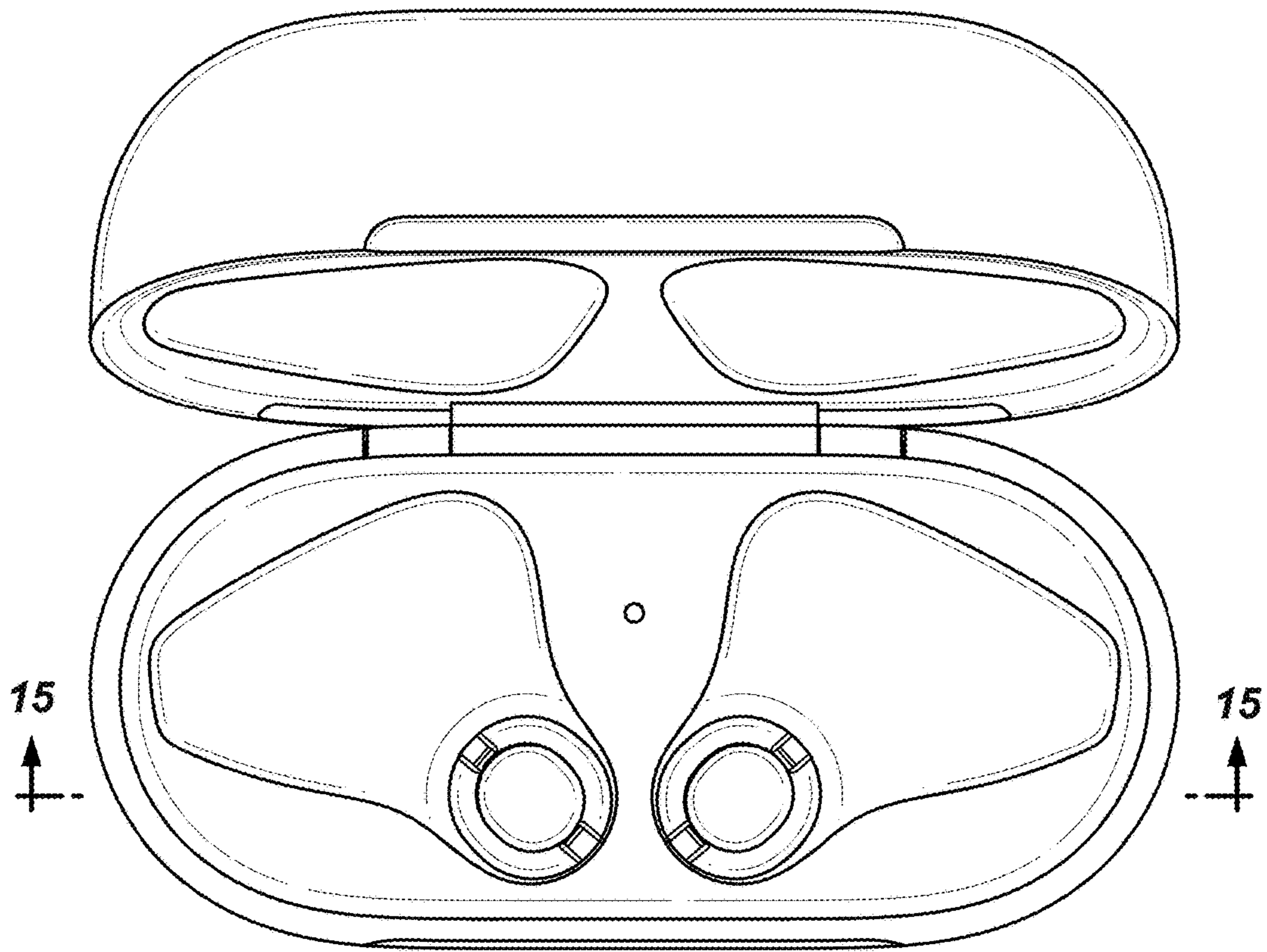

FIG. 13

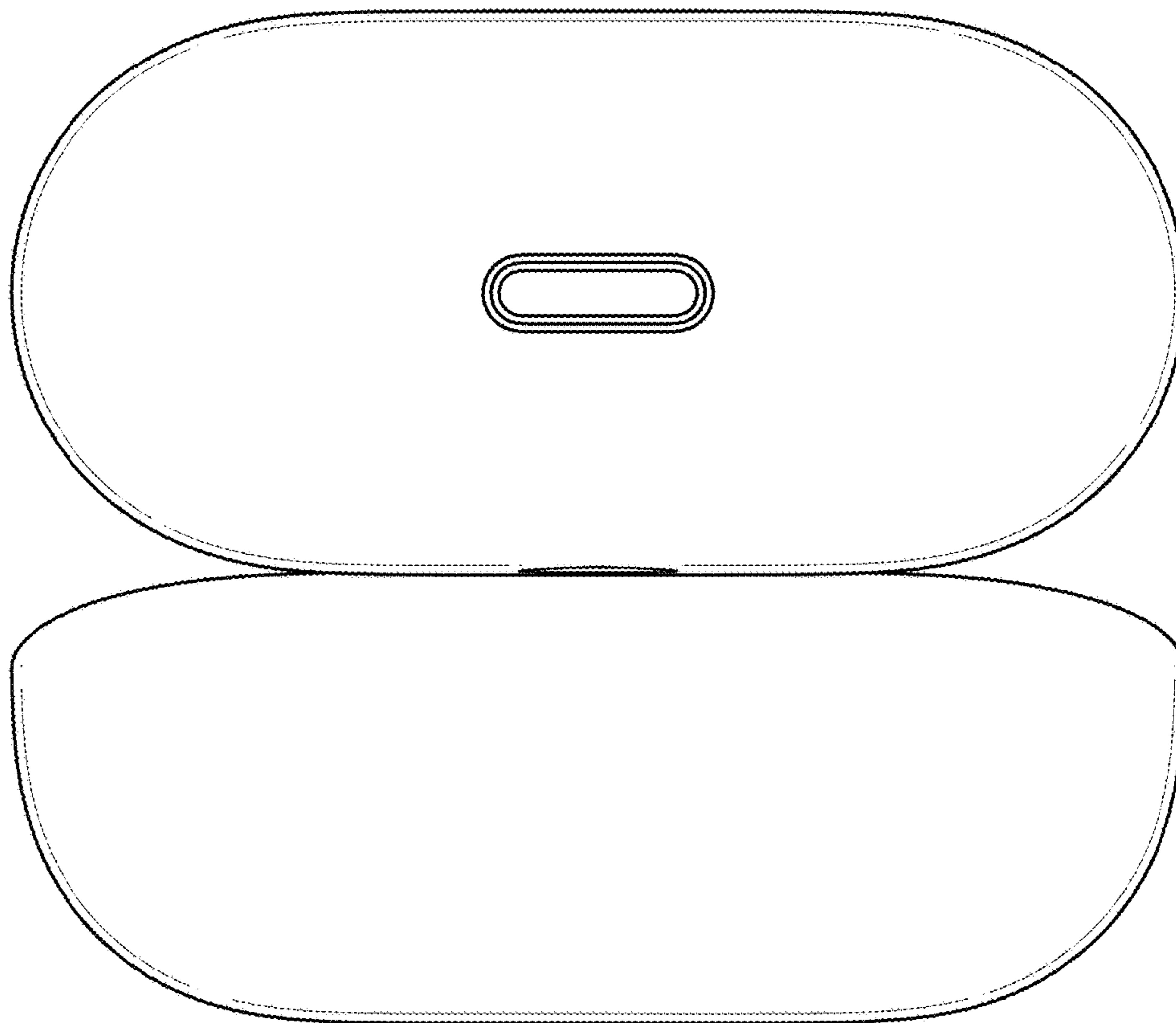

FIG. 14

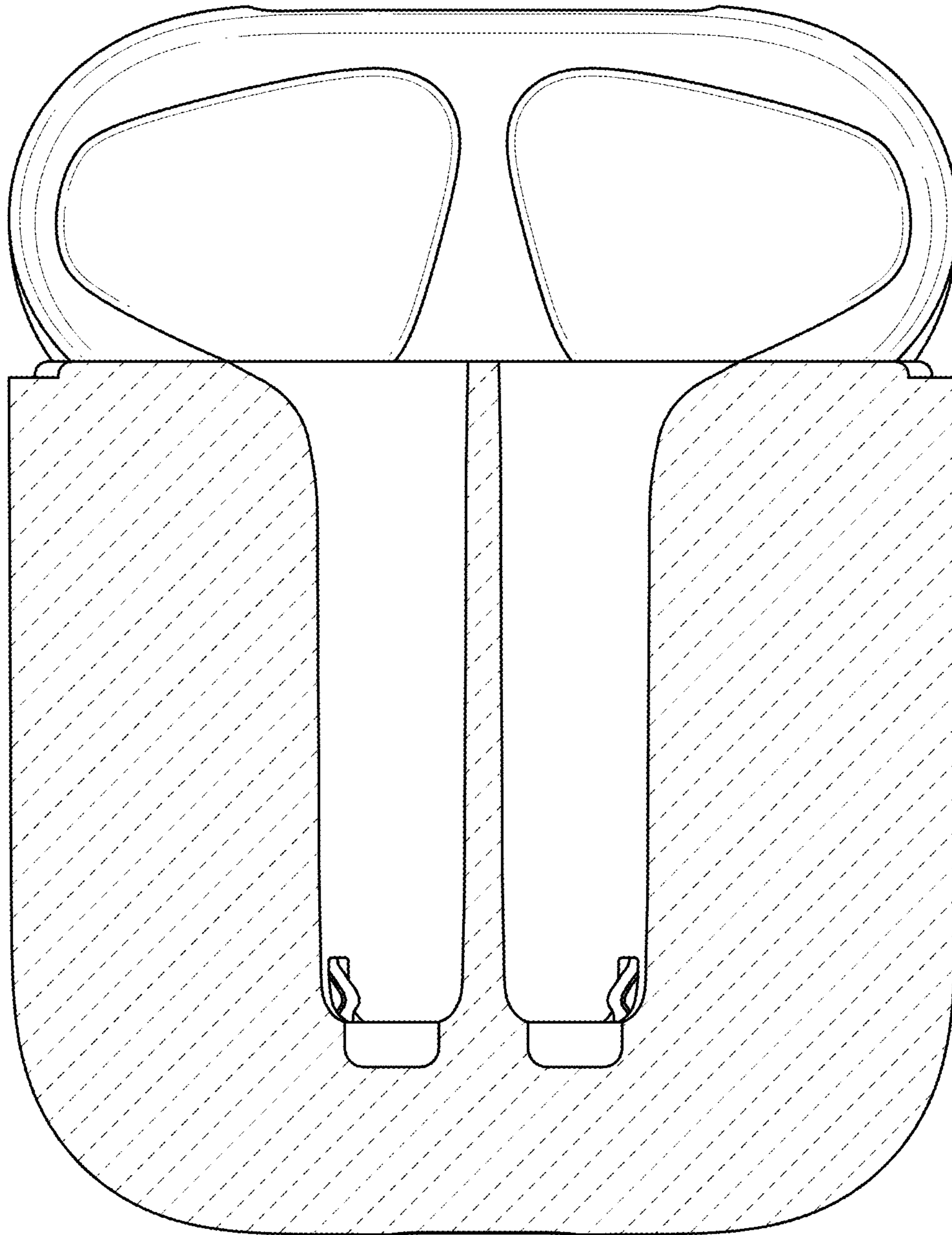

FIG. 15

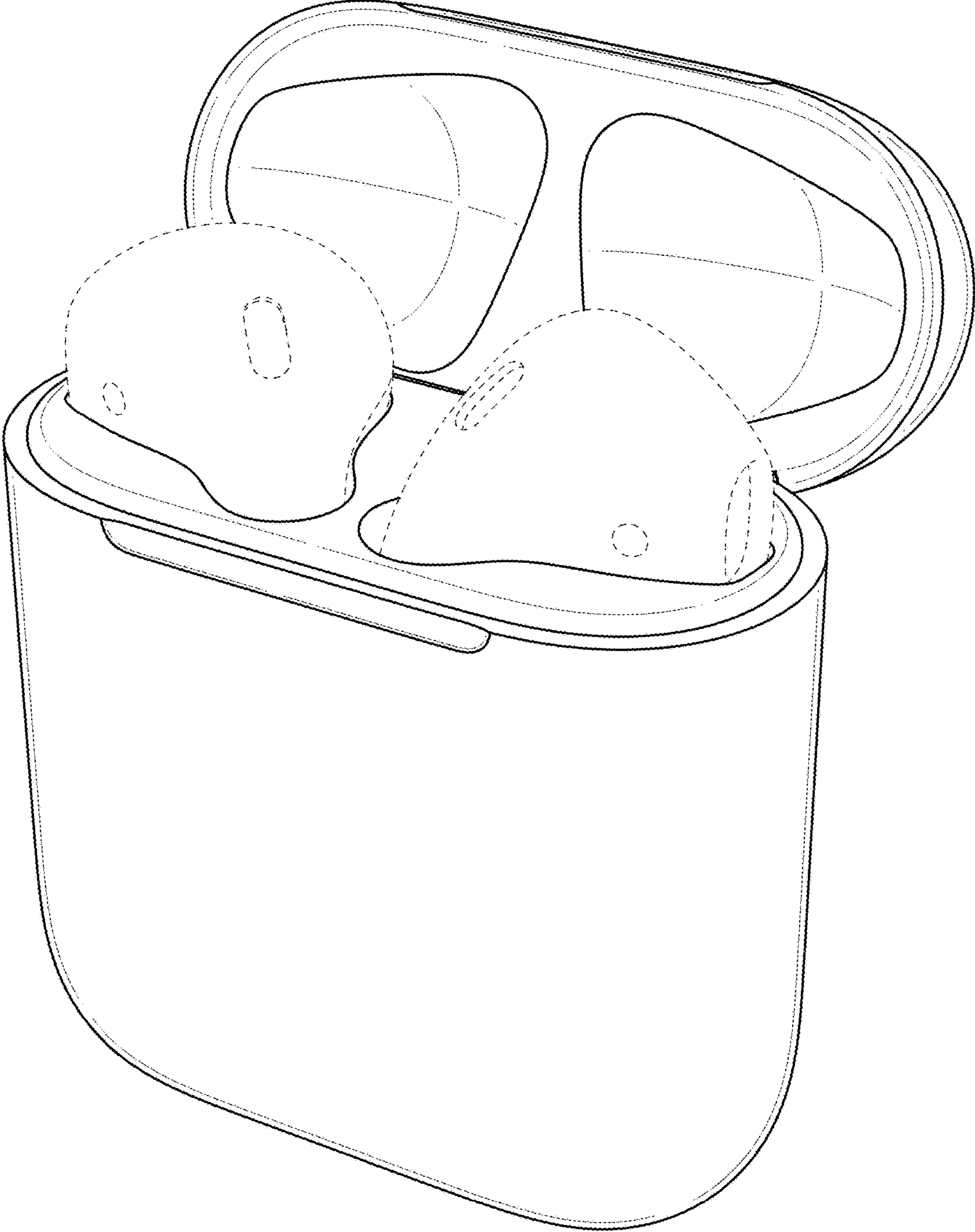

FIG. 16