



US00D806384S

(12) **United States Design Patent**  
**Lopez Montoya**

(10) **Patent No.:** **US D806,384 S**  
(45) **Date of Patent:** **\*\* Jan. 2, 2018**

(54) **BAG**  
(71) Applicant: **Bulgari S.p.A.**, Rome (IT)  
(72) Inventor: **Mireia Lopez Montoya**, Florence (IT)  
(73) Assignee: **BULGARI S.P.A.**, Rome (IT)  
(\*\*) Term: **15 Years**  
(21) Appl. No.: **29/537,060**  
(22) Filed: **Aug. 21, 2015**

5,725,039 A \* 3/1998 Macinai ..... A45C 3/08  
150/104  
D406,456 S \* 3/1999 McDermott ..... D3/201  
D422,405 S \* 4/2000 du Sartel ..... D3/232  
D434,219 S \* 11/2000 Haapala ..... D3/232  
D519,732 S \* 5/2006 Gonzalez ..... D3/243  
D524,045 S \* 7/2006 Handley ..... D3/243  
D525,784 S \* 8/2006 Handley ..... D3/243  
D635,357 S \* 4/2011 Guyon ..... D3/243  
D675,429 S \* 2/2013 Della Valle ..... D3/243  
D685,574 S \* 7/2013 Swingler ..... D3/245  
D698,145 S \* 1/2014 Deneve ..... D3/243  
D728,225 S \* 5/2015 McNamara ..... D3/243

\* cited by examiner

(30) **Foreign Application Priority Data**

Feb. 23, 2015 (WO) ..... DM/085804

(51) **LOC (11) Cl.** ..... **03-01**  
(52) **U.S. Cl.**  
USPC ..... **D3/243**

(58) **Field of Classification Search**  
USPC ..... D3/215-217, 226, 227, 232-234,  
D3/238-246, 254, 257, 270, 271.1, 271.9,  
D3/272, 274-276, 291, 294, 299, 303,  
D3/324, 326, 900, 902, 903  
CPC ..... A45C 1/00; A45C 3/06; A45C 2007/004;  
A45C 3/08; A45C 7/00; A45C 9/10  
See application file for complete search history.

(56) **References Cited**

**U.S. PATENT DOCUMENTS**

3,346,155 A \* 10/1967 Oechsle ..... A45F 5/12  
150/108  
D260,198 S \* 8/1981 Siegel ..... D3/243  
D324,770 S \* 3/1992 Dixsaut ..... D3/243

*Primary Examiner* — Susan E Krakower  
*Assistant Examiner* — L. A. Grabenstetter  
(74) *Attorney, Agent, or Firm* — Stephen Kenny; Peter  
Sullivan; Foley Hoag LLP

(57) **CLAIM**

The ornamental design for a bag, as shown and described.

**DESCRIPTION**

FIG. 1 is a front view of a bag, showing my new design;  
FIG. 2 is a back view thereof;  
FIG. 3 is a perspective view thereof;  
FIG. 4 is a bottom view thereof;  
FIG. 5 is a top view thereof;  
FIG. 6 is a left side view thereof;  
FIG. 7 is a right side view thereof; and,  
FIG. 8 is a top perspective view thereof, shown in an open  
condition, with the strap removed for clarity.  
The portions depicted unclaimed portions of the bag.

**1 Claim, 8 Drawing Sheets**

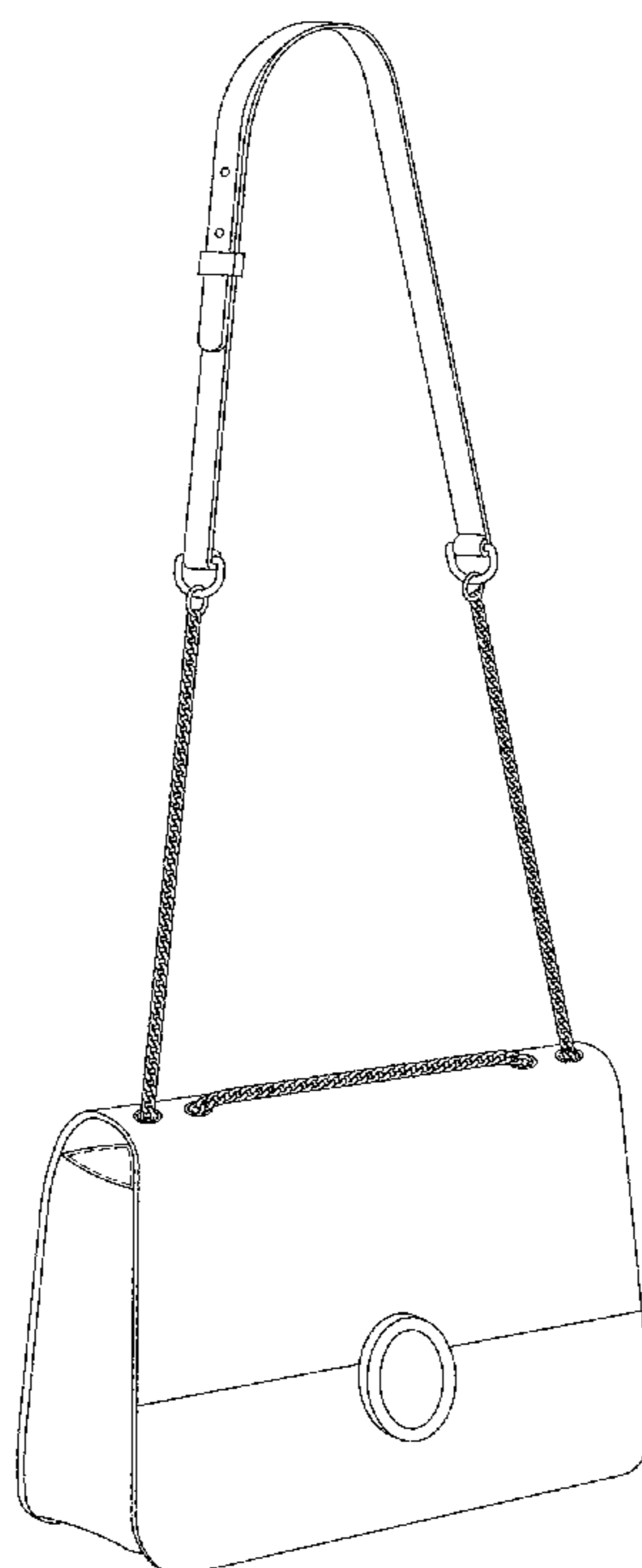



FIG. 1



FIG. 2

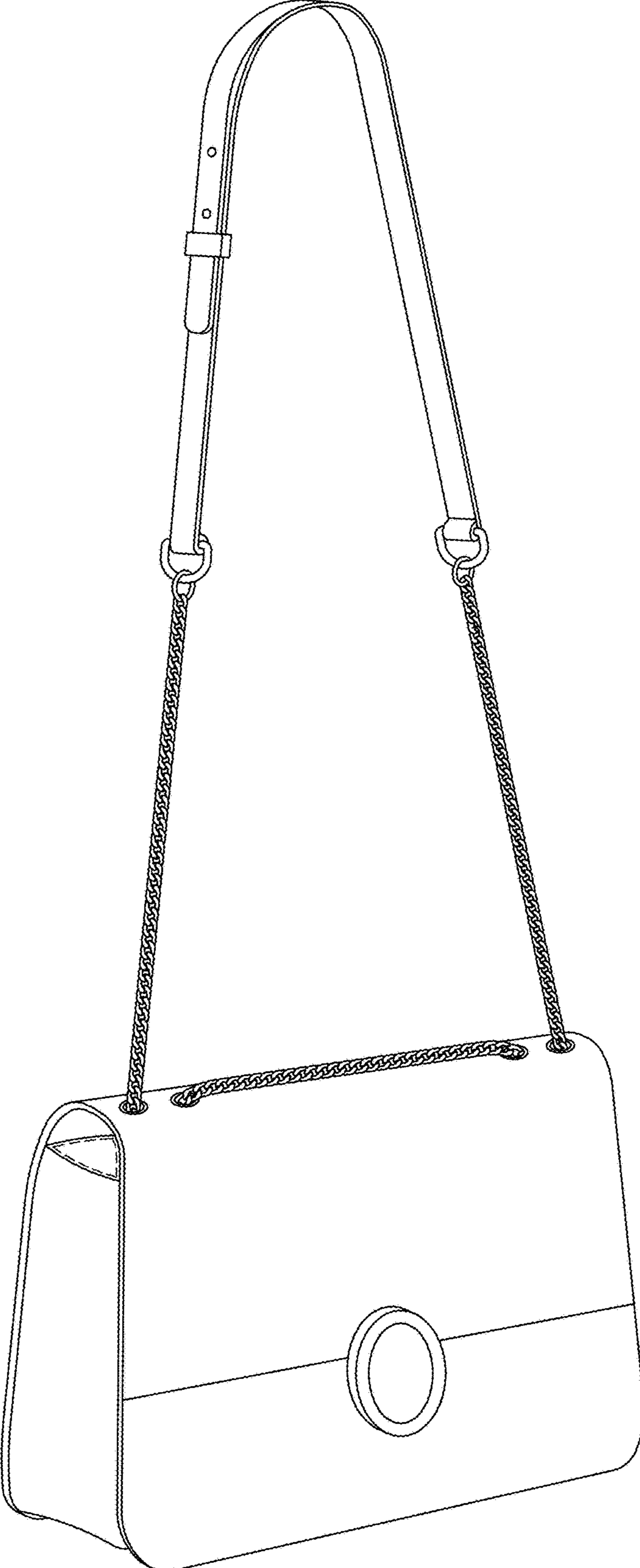

FIG. 3

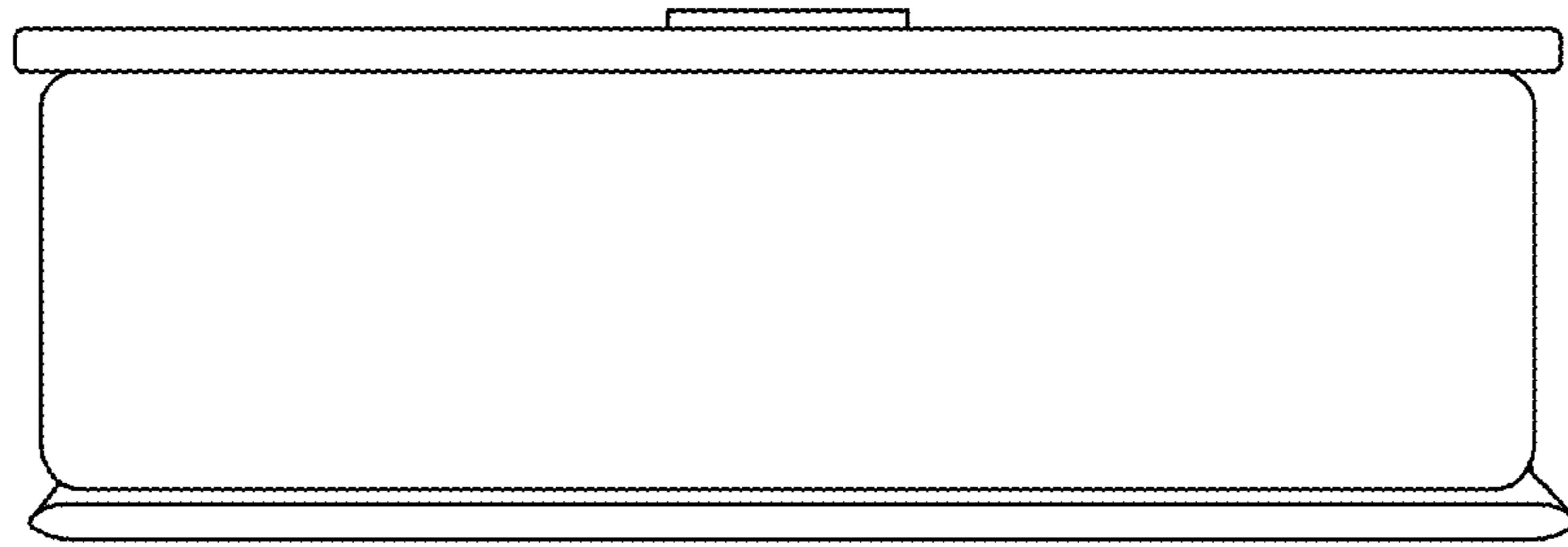

FIG.4

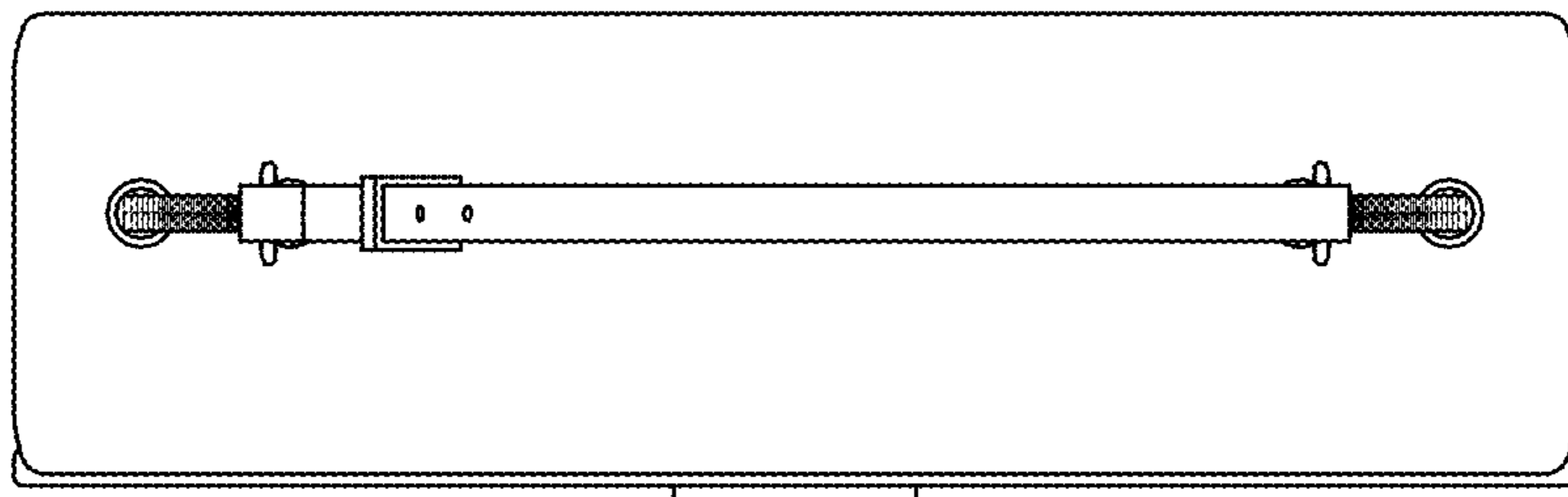

FIG. 5

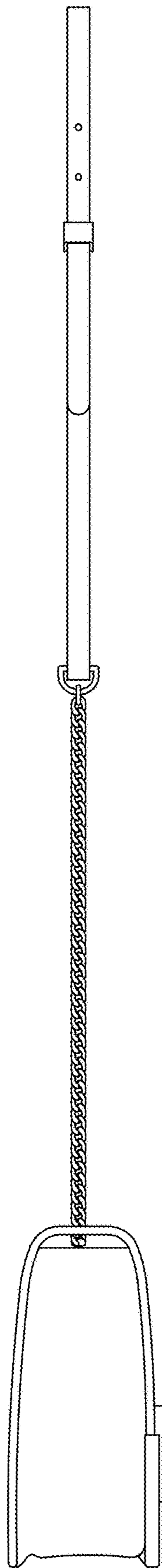

FIG. 6

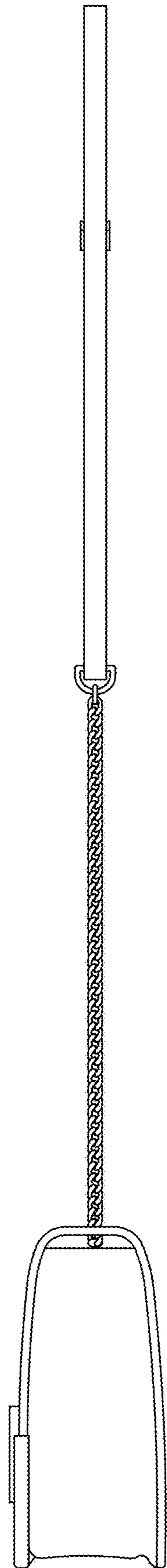

FIG. 7



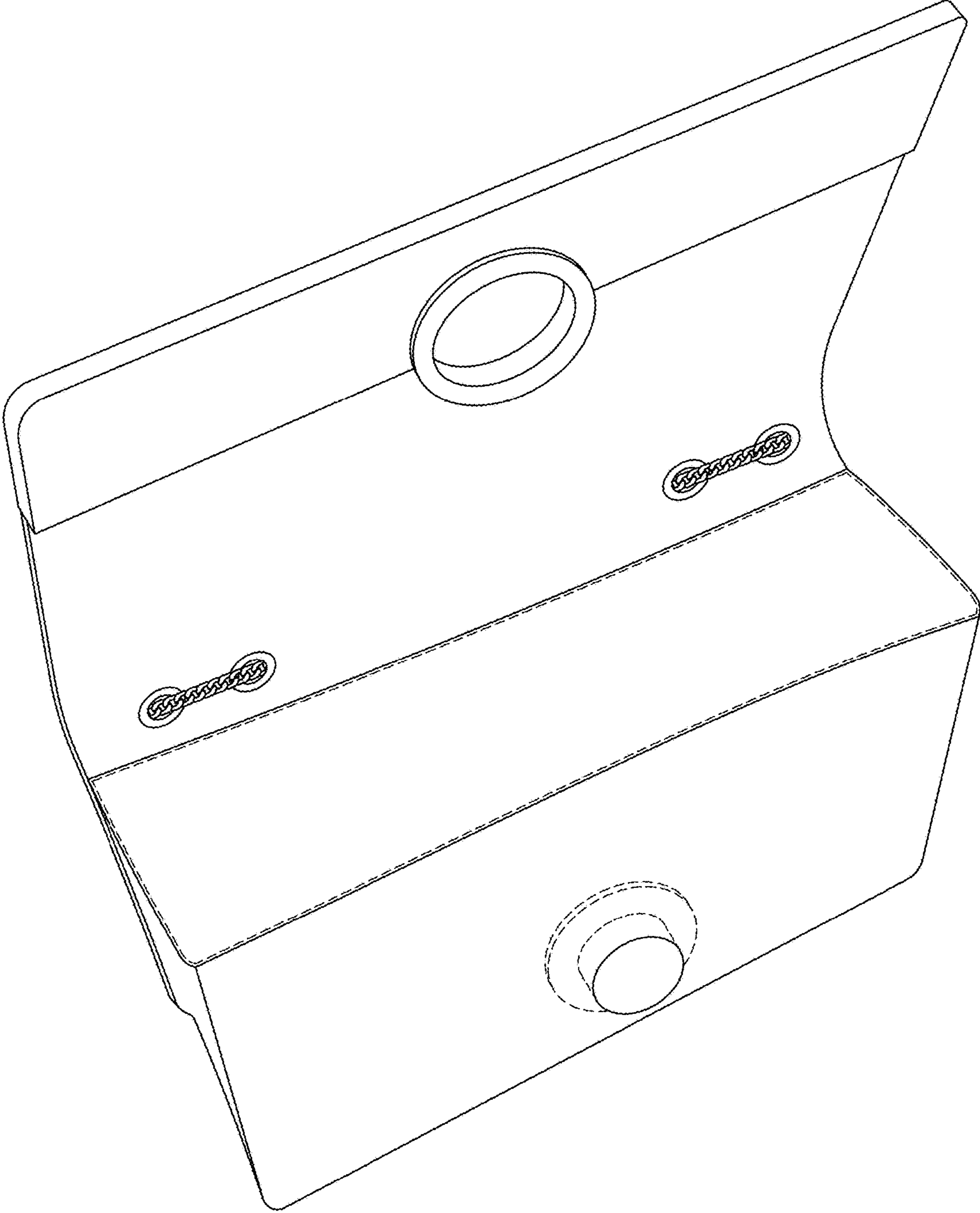

FIG.8