



US00D806332S

(12) **United States Design Patent**
Griffin et al.

(10) **Patent No.:** **US D806,332 S**

(45) **Date of Patent:** **** Dec. 26, 2017**

(54) **VACUUM CLEANER**

(71) Applicant: **SHOP VAC CORPORATION**,
Williamsport, PA (US)

(72) Inventors: **John Griffin**, Phoenix, AZ (US); **Jason Gottschall**, South Williamsport, PA (US); **Craig A. Seasholtz**, Avis, PA (US)

(73) Assignee: **SHOP VAC CORPORATION**,
Williamsport, PA (US)

(**) Term: **15 Years**

(21) Appl. No.: **29/577,570**

(22) Filed: **Sep. 14, 2016**

(51) **LOC (10) Cl.** **15-05**

(52) **U.S. Cl.**
USPC **D32/21**

(58) **Field of Classification Search**
USPC D32/17, 21-24, 31
CPC D06F 87/00; D06F 75/06; D06F 73/00;
F22B 1/284; F24F 6/025; B44C 7/027;
A47L 11/34; A47L 9/2842; A47L 5/362;
A47L 5/365; A47L 7/0038; A04H 4/1636;
A04H 4/1654; A04H 4/169; E04H
4/1272; B01D 35/26

See application file for complete search history.

(56) **References Cited**

U.S. PATENT DOCUMENTS

D528,718 S * 9/2006 Tomasiak D32/21
D581,111 S * 11/2008 DiPasquale D32/21
D587,868 S * 3/2009 DiPasquale D32/21
D615,258 S * 5/2010 Dammkoehler D32/23

D655,872 S * 3/2012 Jin D32/21
D660,529 S * 5/2012 Dammkoehler D32/21
D675,388 S * 1/2013 Buck D32/21
D676,205 S * 2/2013 Theising D32/21
D743,648 S * 11/2015 Imsand D32/21
D746,523 S * 12/2015 Jin D32/21
9,572,464 B2 * 2/2017 Wehner A47L 5/365
D782,759 S * 3/2017 Mathiassen D32/21

* cited by examiner

Primary Examiner — Ruth McInroy

(74) *Attorney, Agent, or Firm* — Marshall, Gerstein & Borun LLP

(57) **CLAIM**

The ornamental design for a vacuum cleaner, as shown and described.

DESCRIPTION

FIG. 1 is a top, front and right-side perspective view of a vacuum cleaner showing our new design; FIG. 2 is a front elevation view thereof; FIG. 3 is a right-side elevation view thereof; FIG. 4 is a top plan view thereof; FIG. 5 is a left-side elevation view thereof; FIG. 6 is a rear elevation view thereof; FIG. 7 is a bottom plan view thereof; FIG. 8 is a top, front and right-side perspective view of a second embodiment thereof; FIG. 9 is a front elevation view of FIG. 8; FIG. 10 is a right-side elevation view of FIG. 8; FIG. 11 is a top plan view of FIG. 8; FIG. 12 is a left-side elevation view of FIG. 8; FIG. 13 is a rear elevation view of FIG. 8; and, FIG. 14 is a bottom plan view of FIG. 8.

The broken lines represent portions of the vacuum cleaner that form no part of the claimed design.

1 Claim, 14 Drawing Sheets

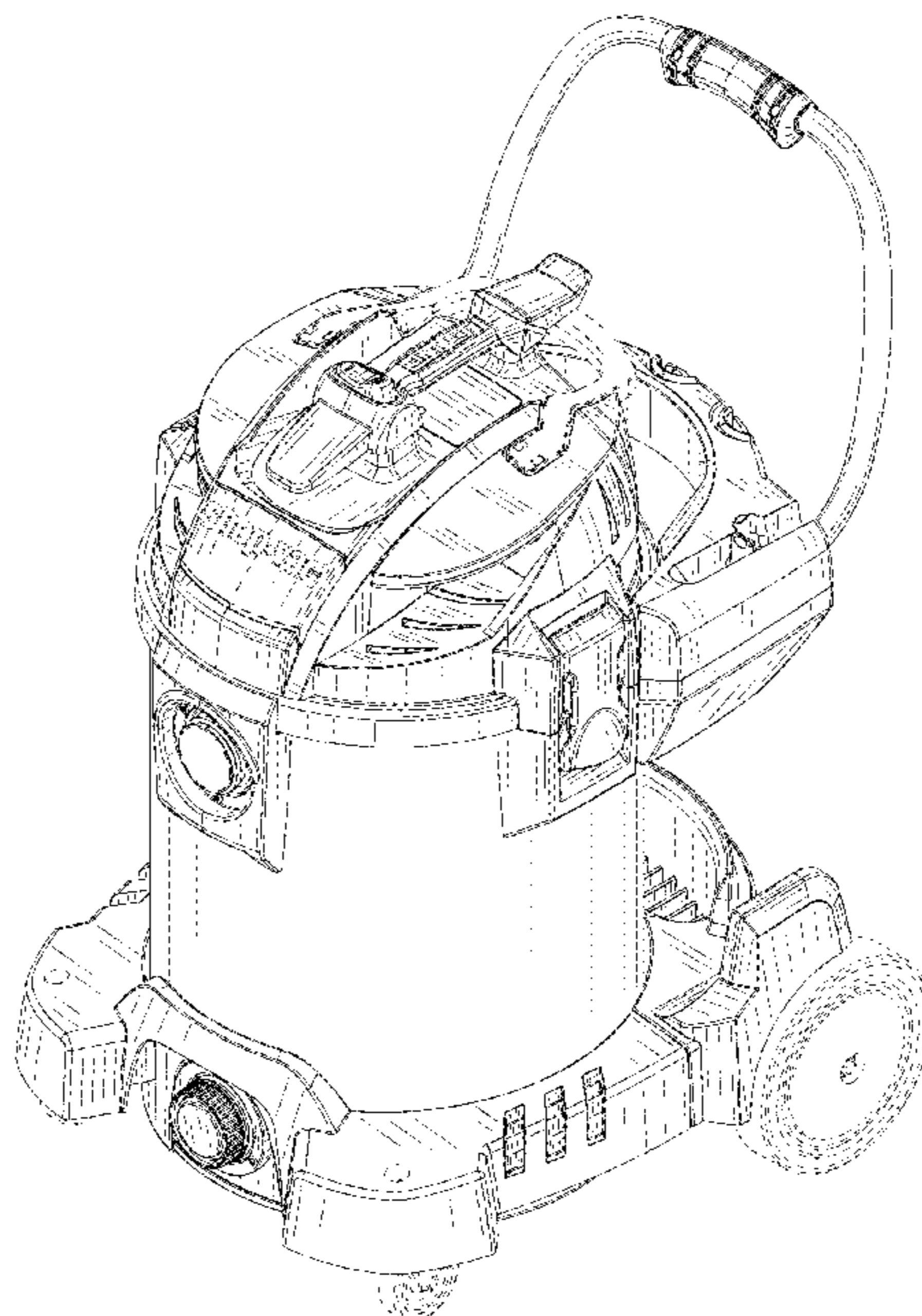
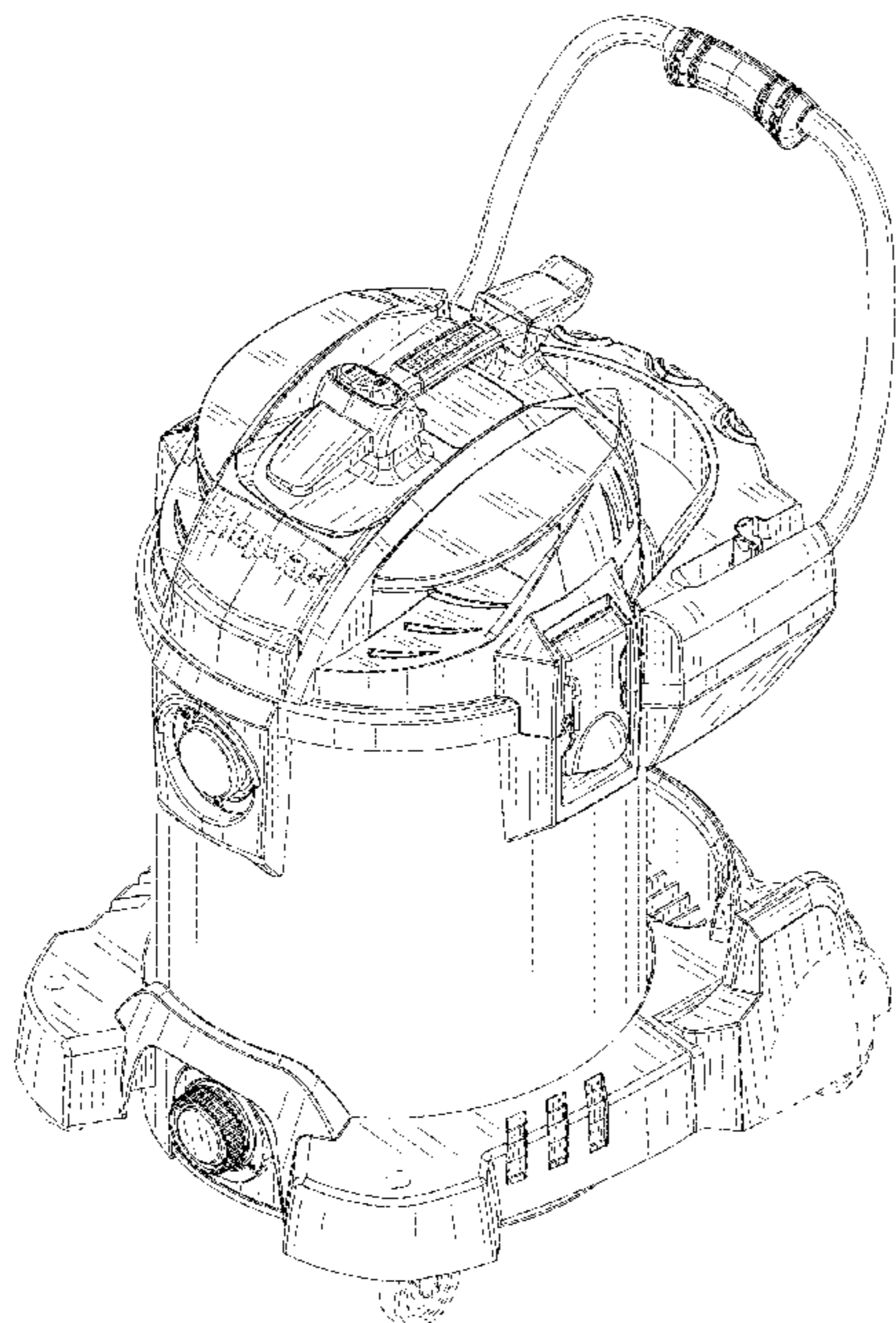

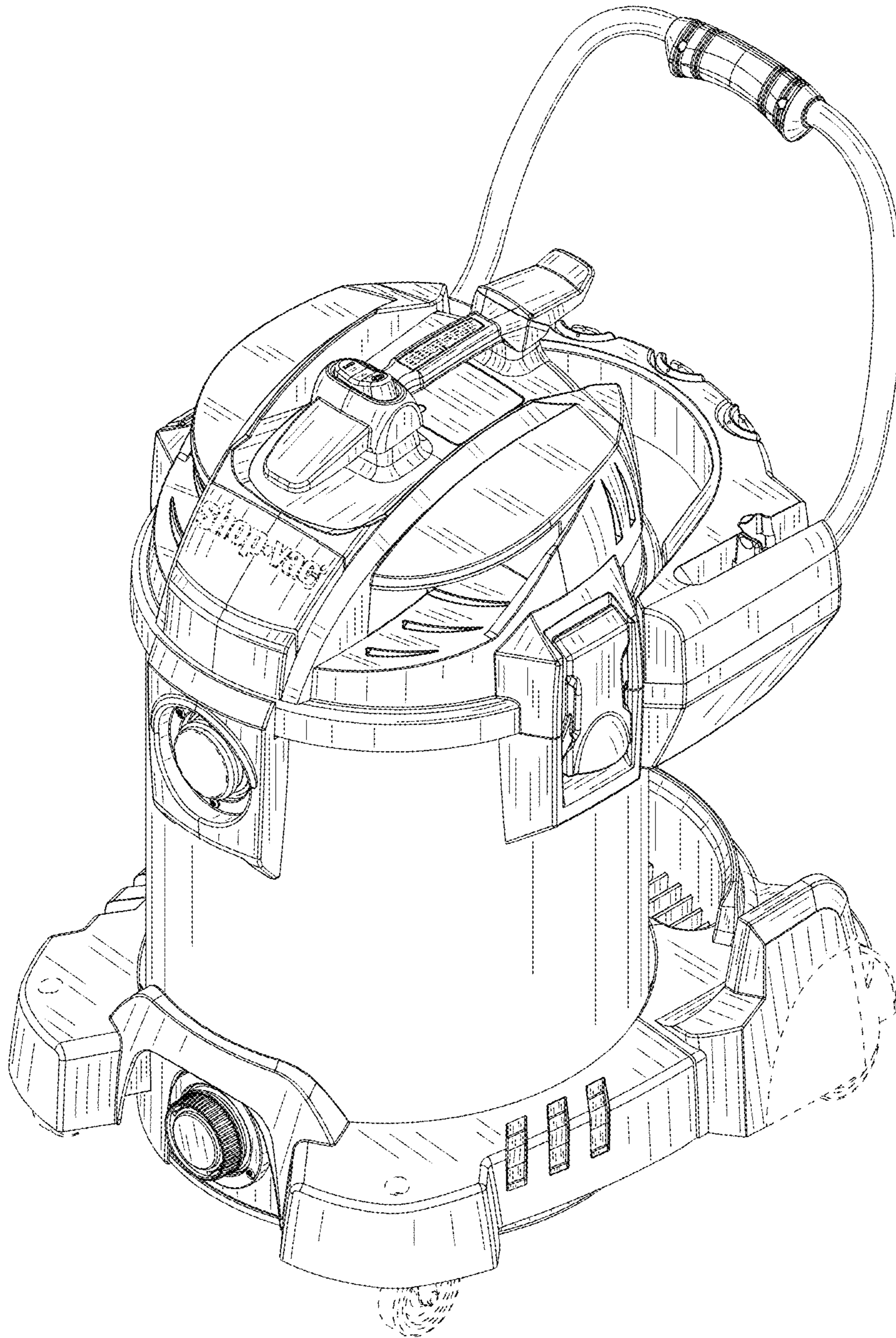

FIG. 1

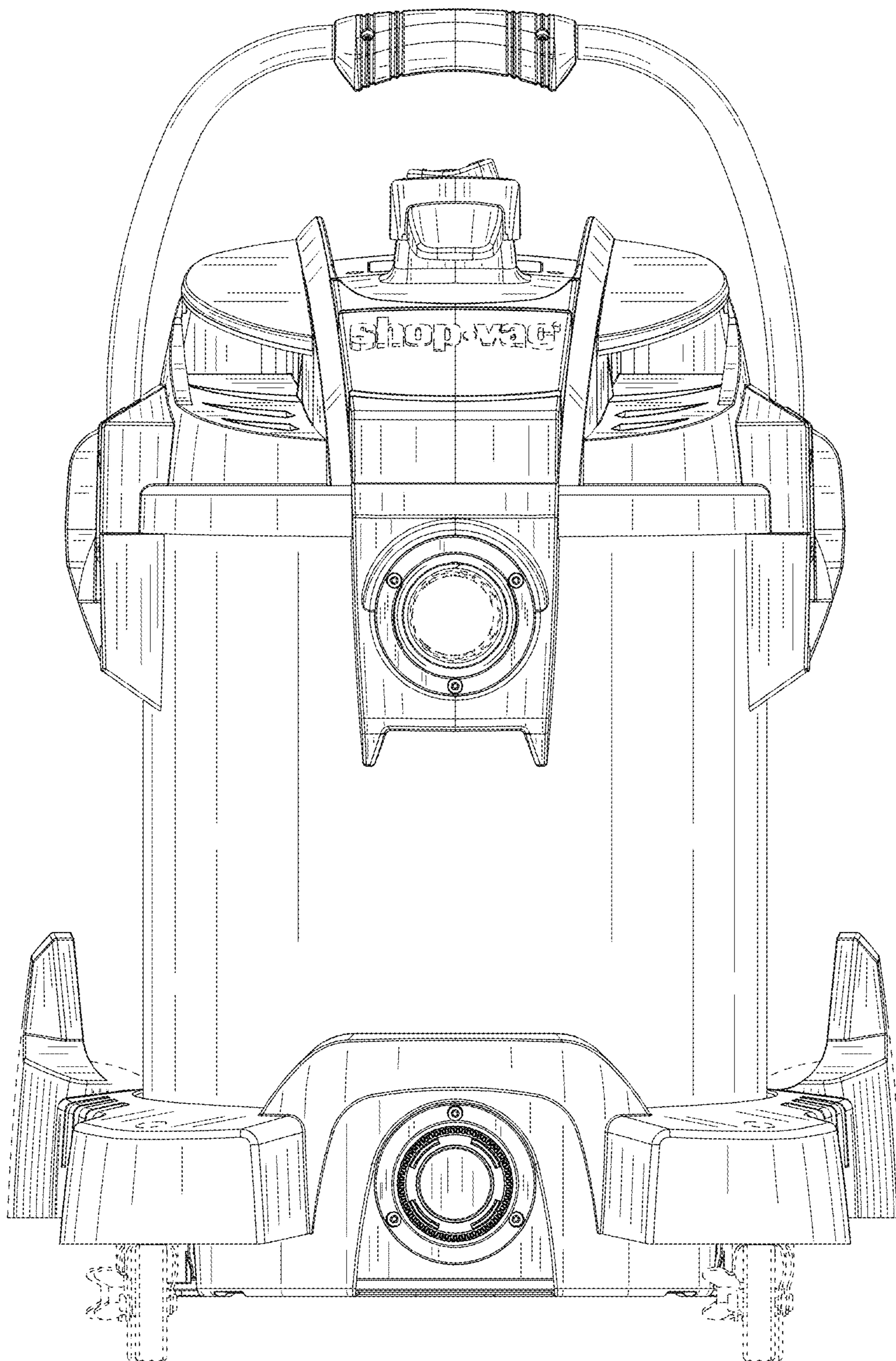

FIG. 2

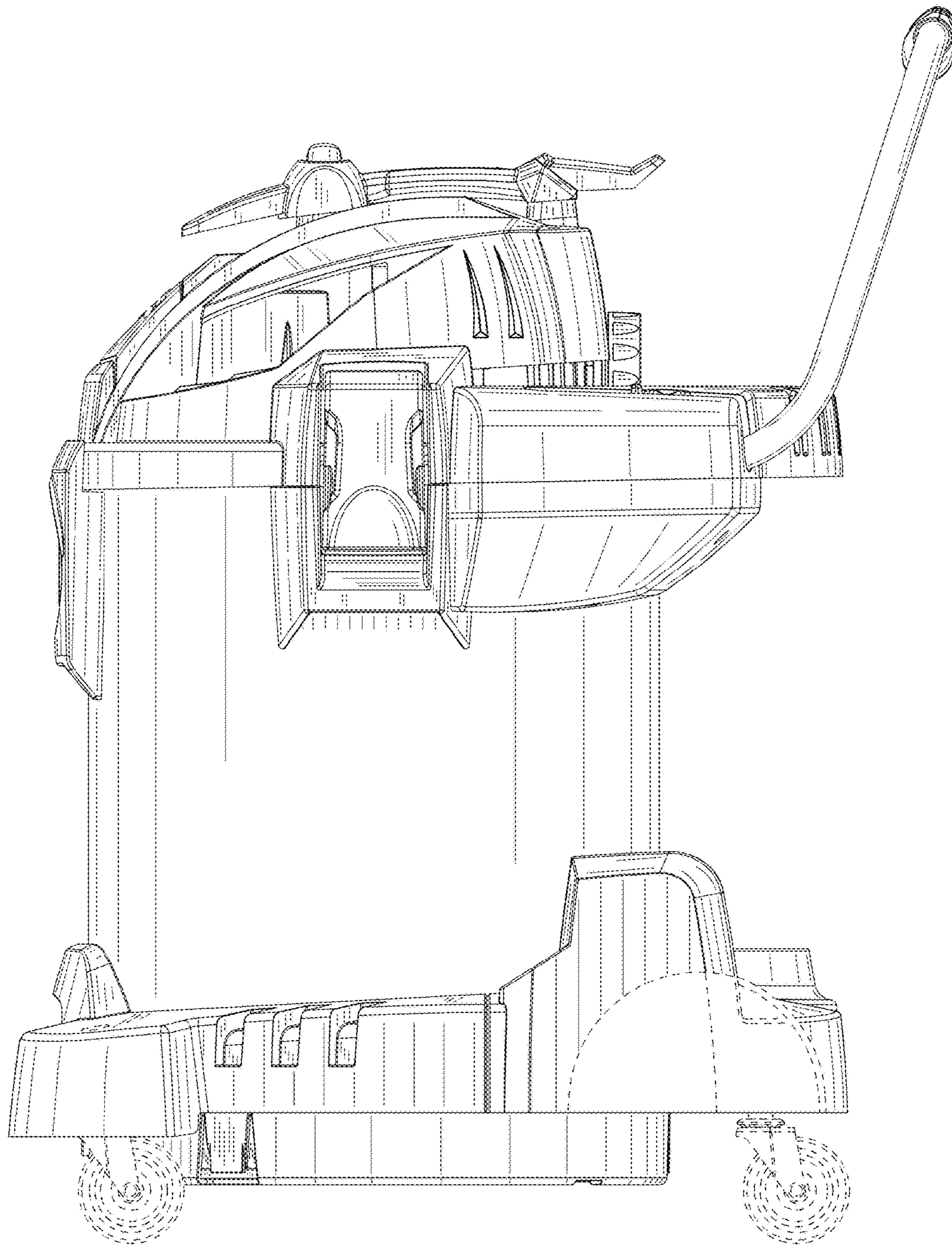

FIG. 3

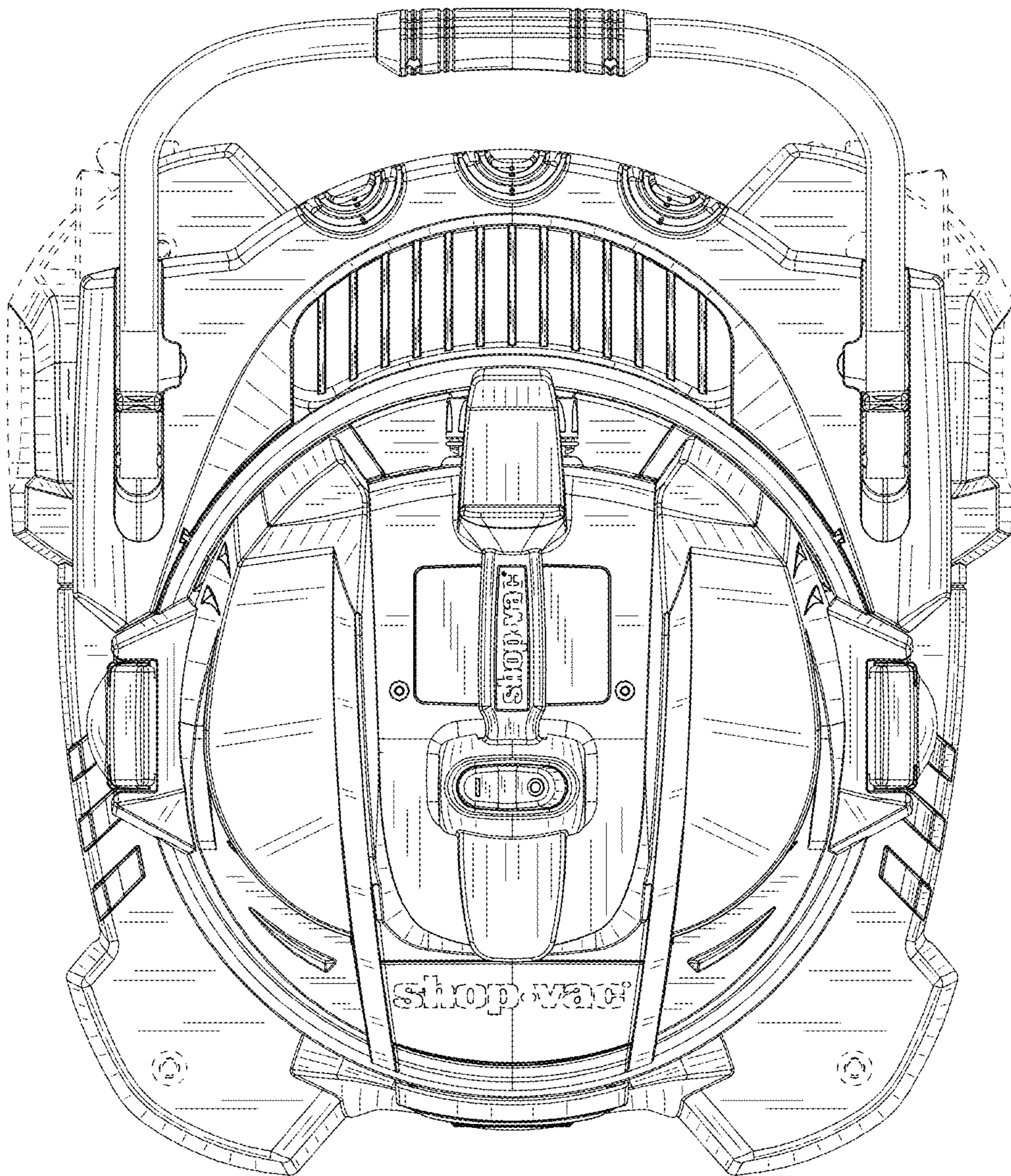

FIG. 4

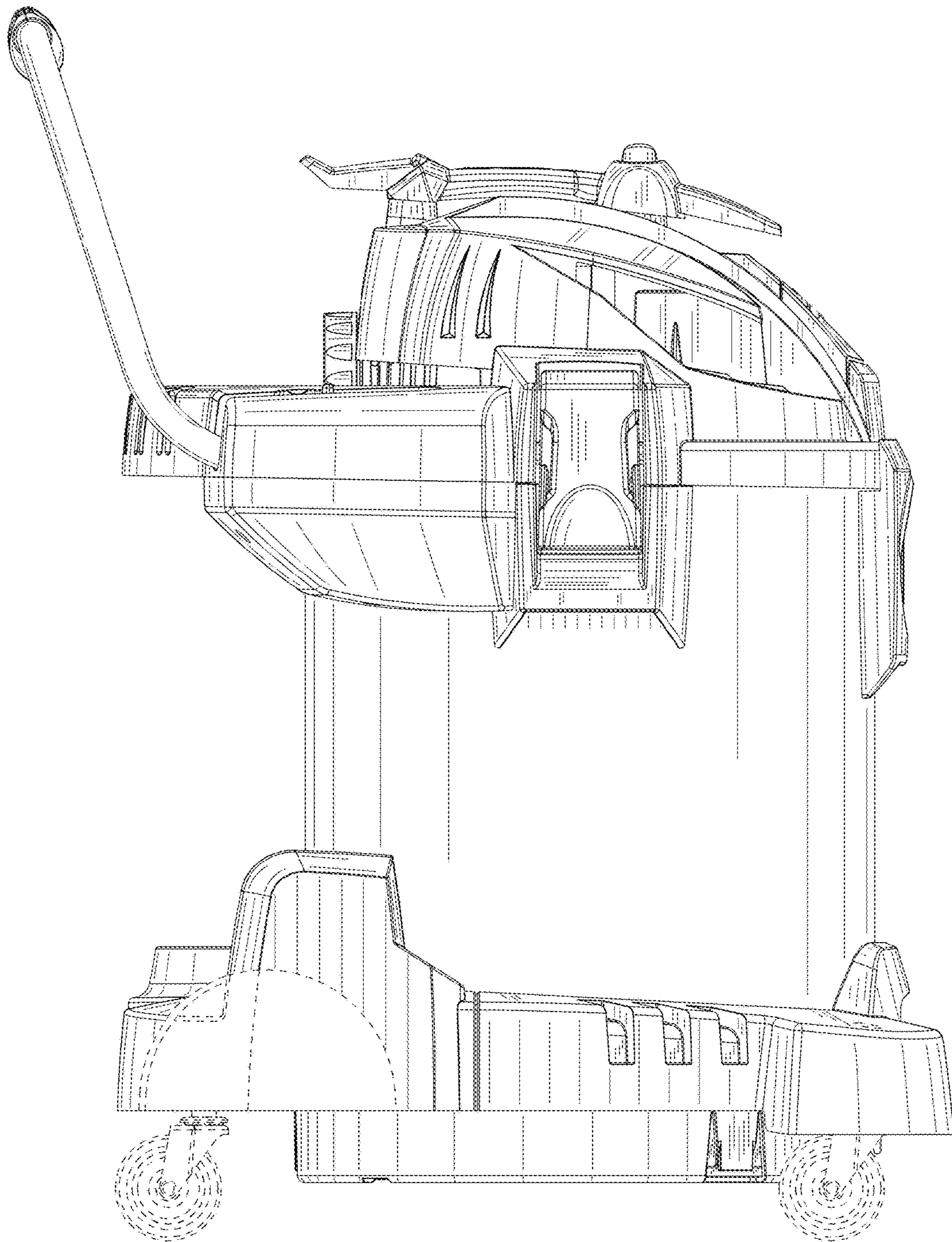

FIG. 5

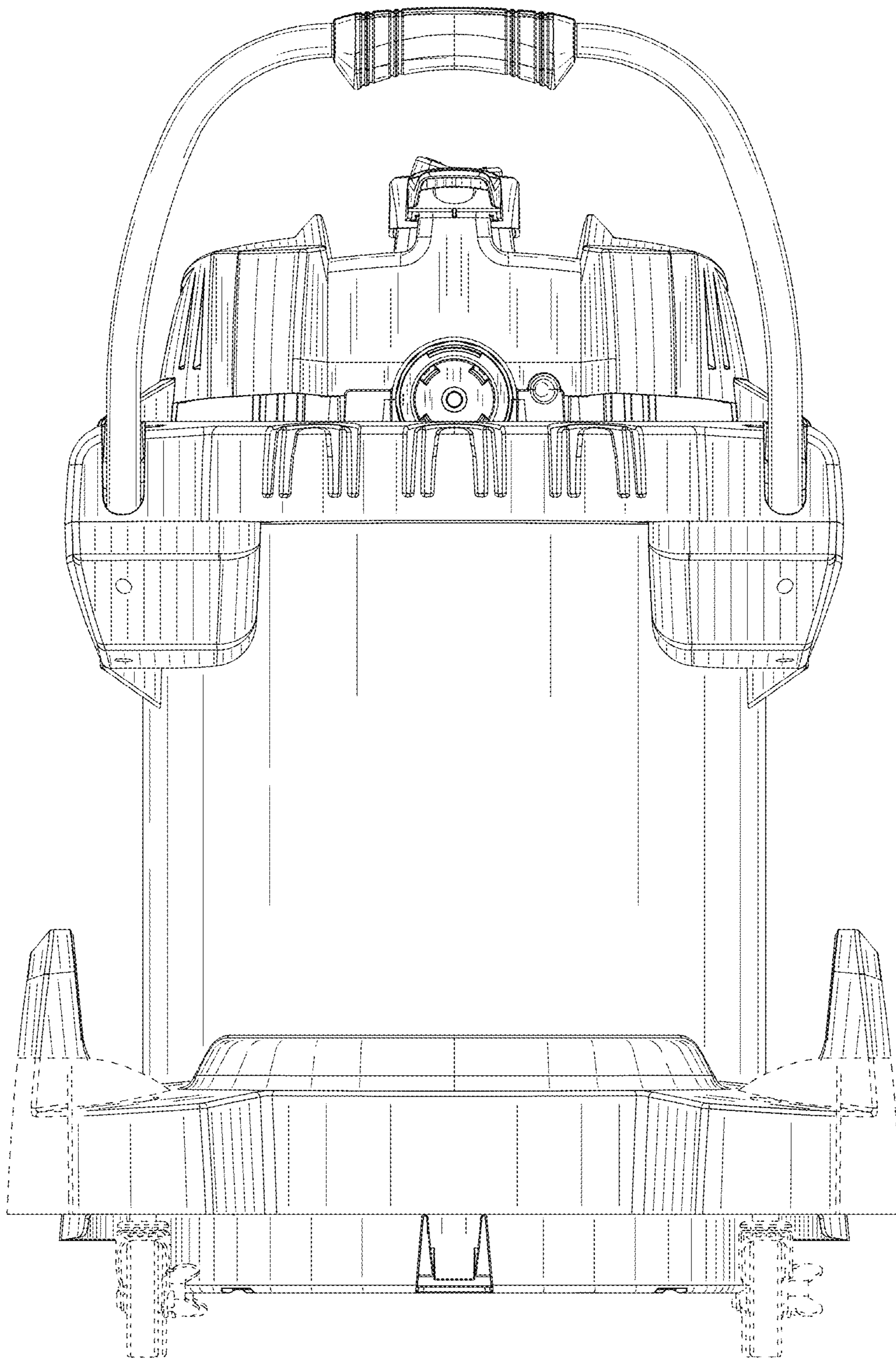

FIG. 6

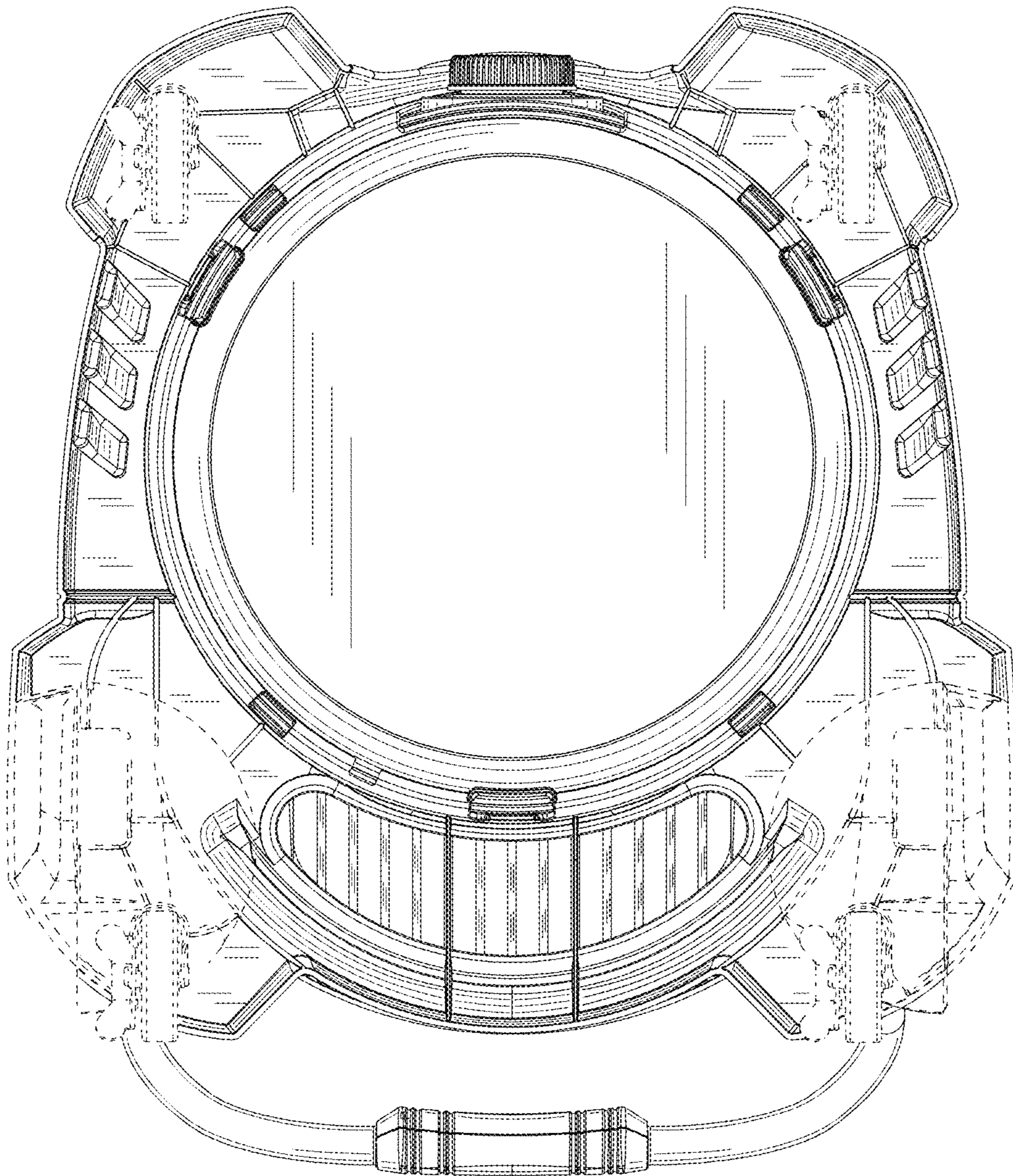

FIG. 7

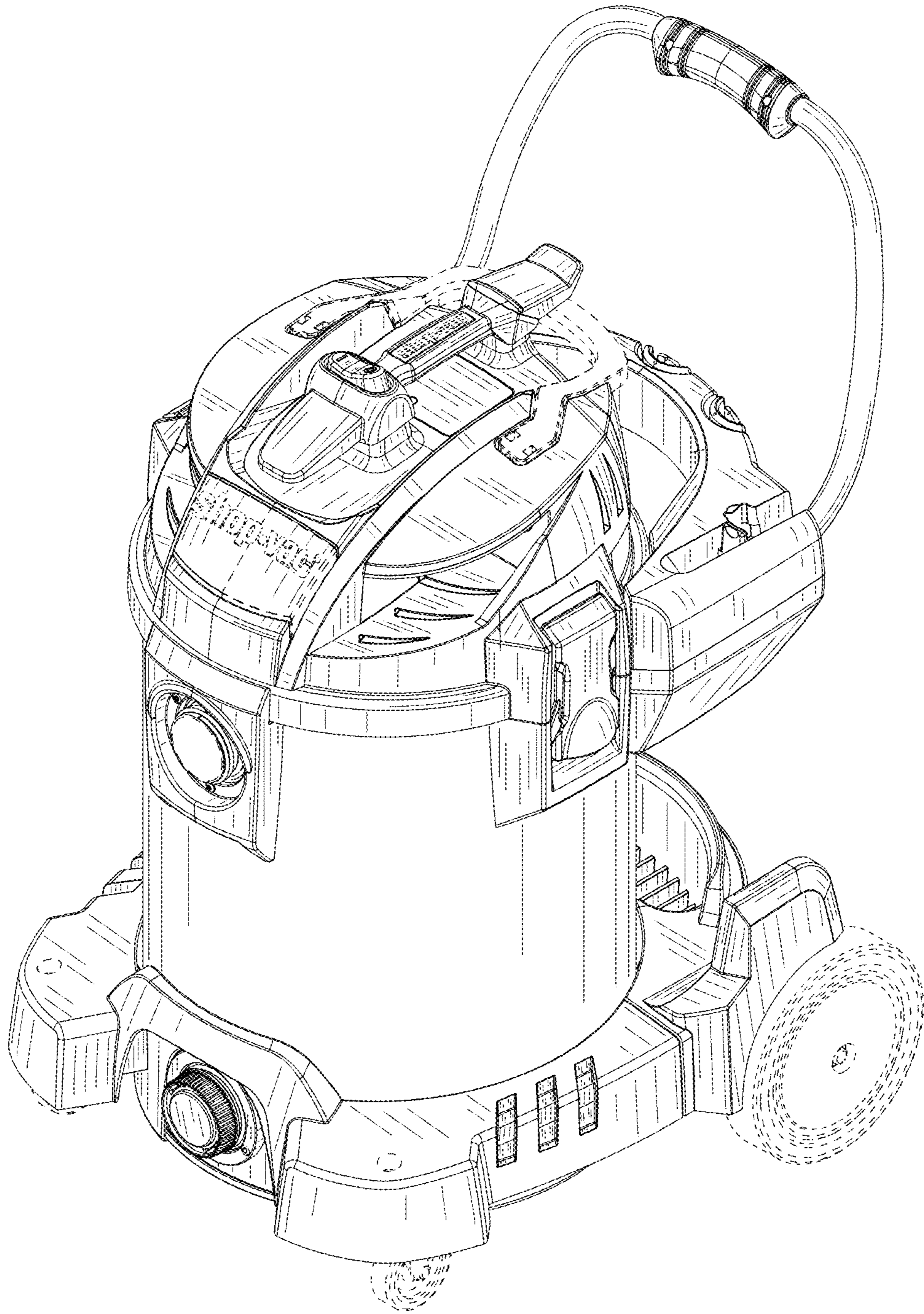

FIG. 8

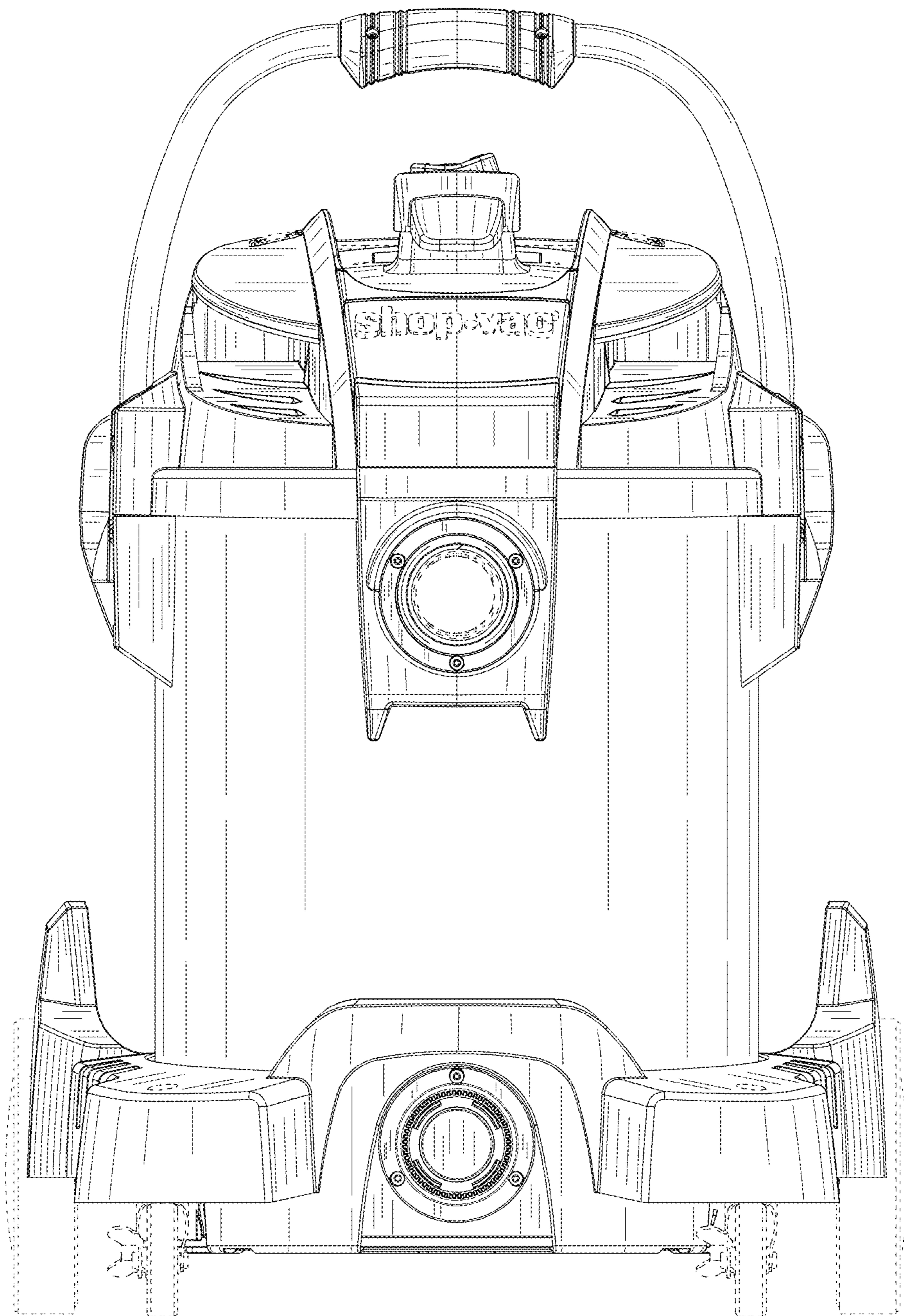

FIG. 9

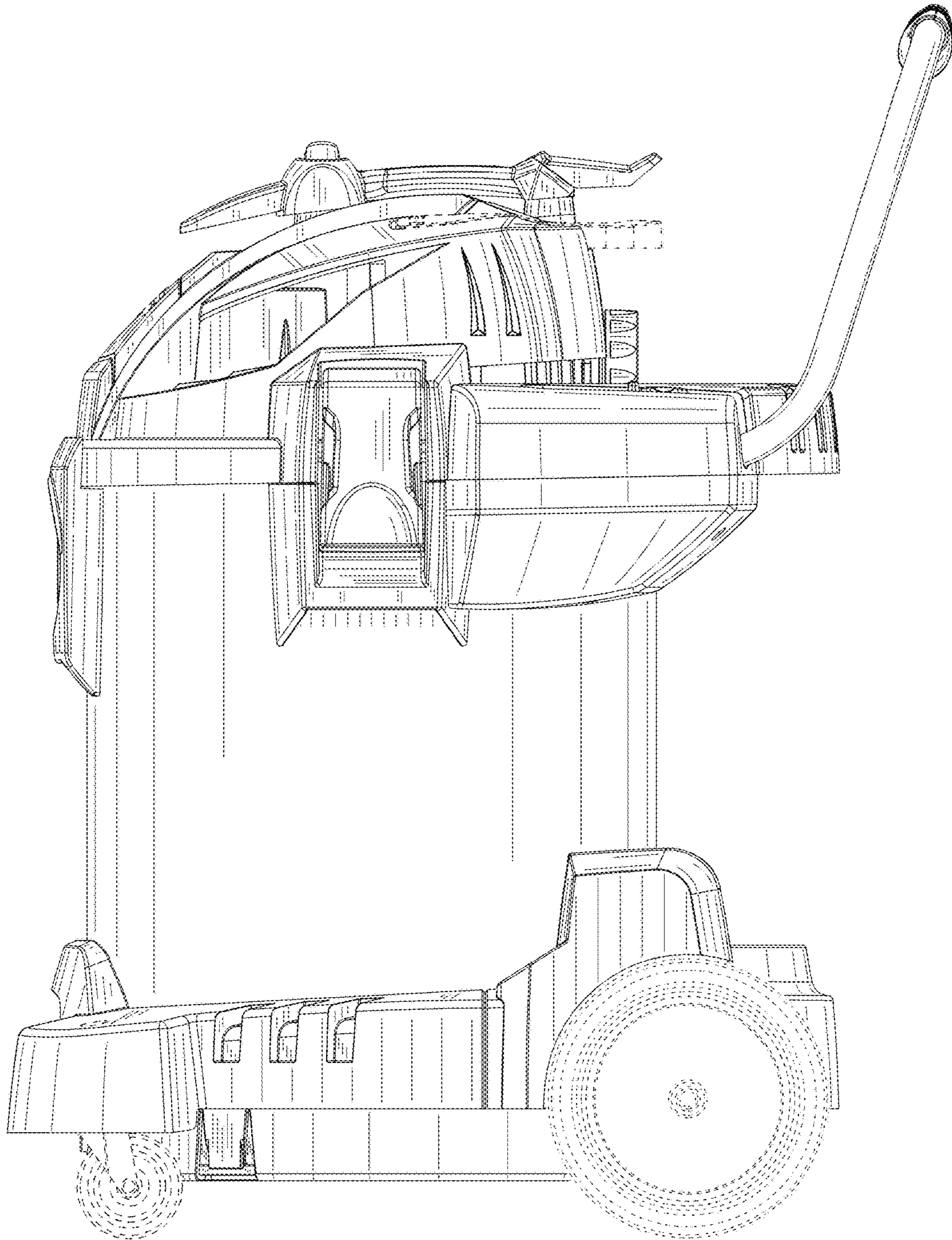

FIG. 10

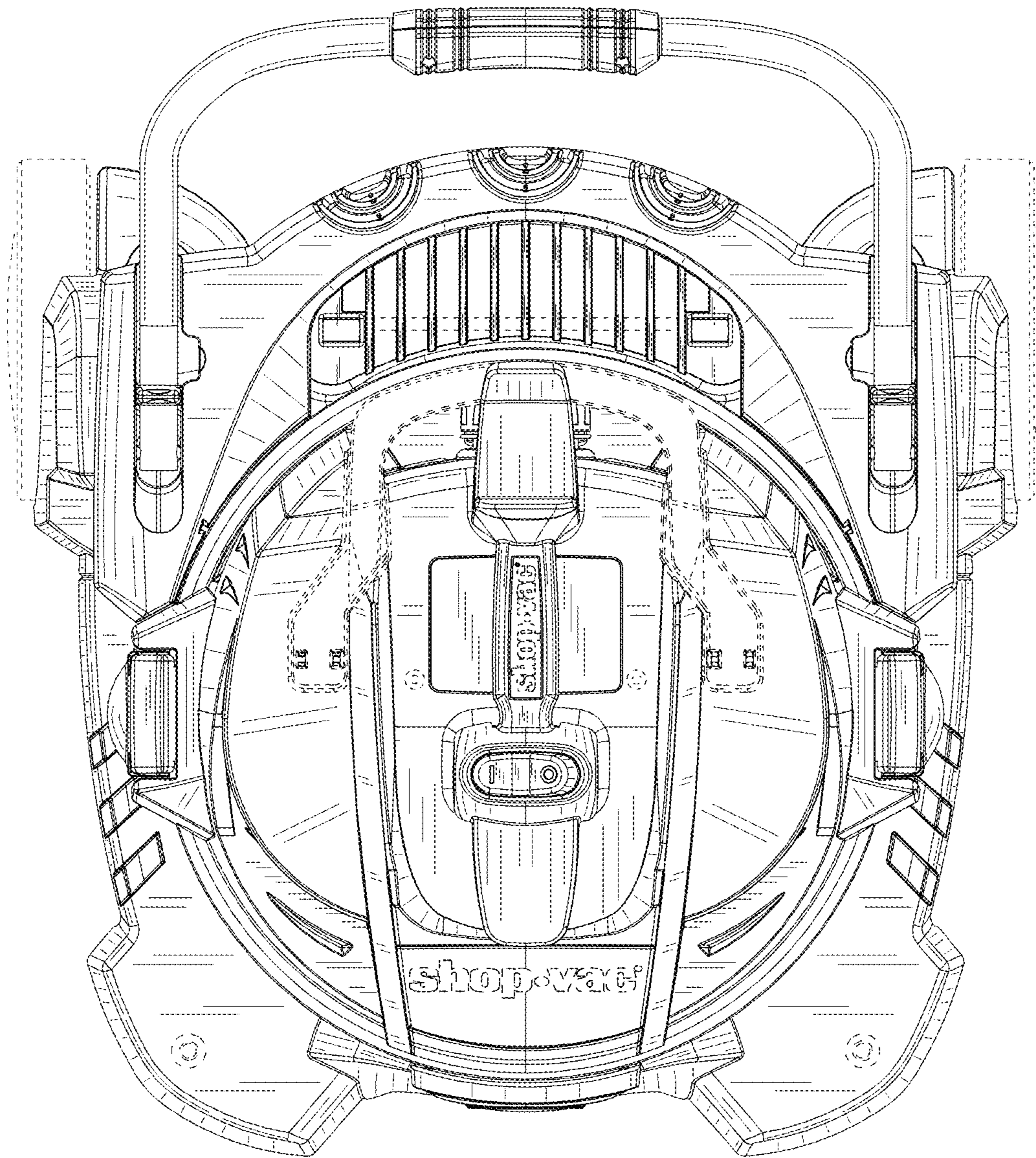

FIG. 11

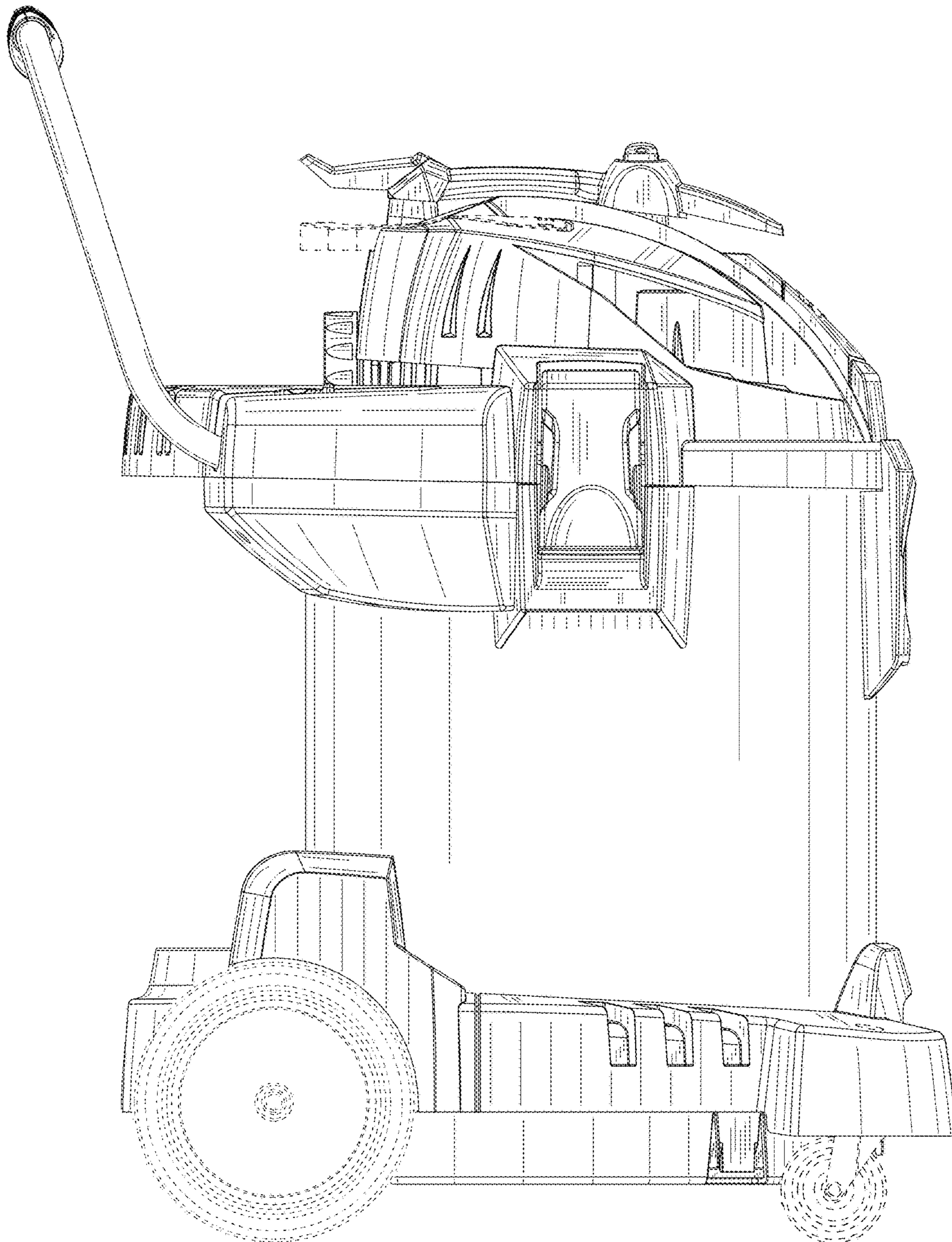

FIG. 12

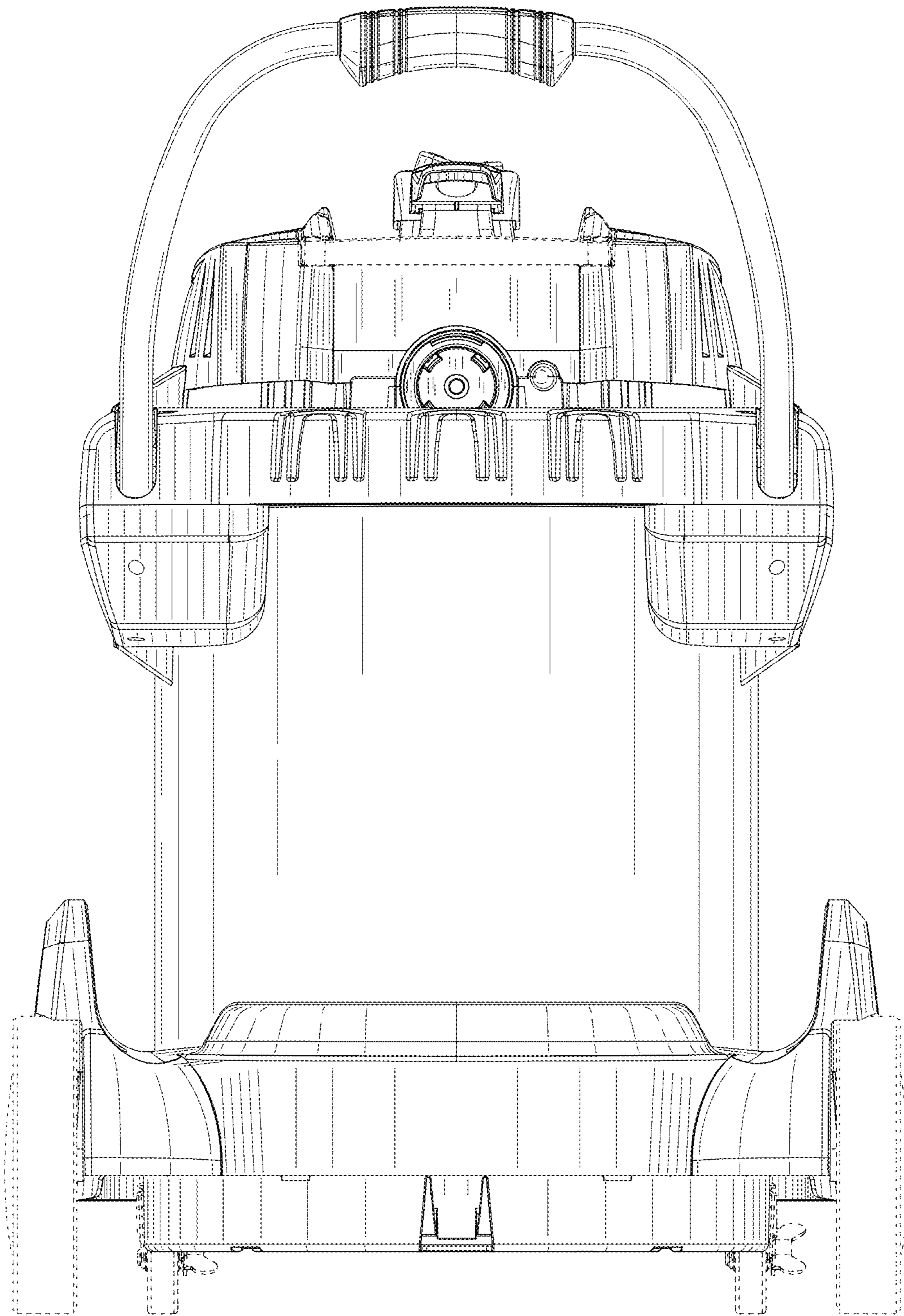

FIG. 13

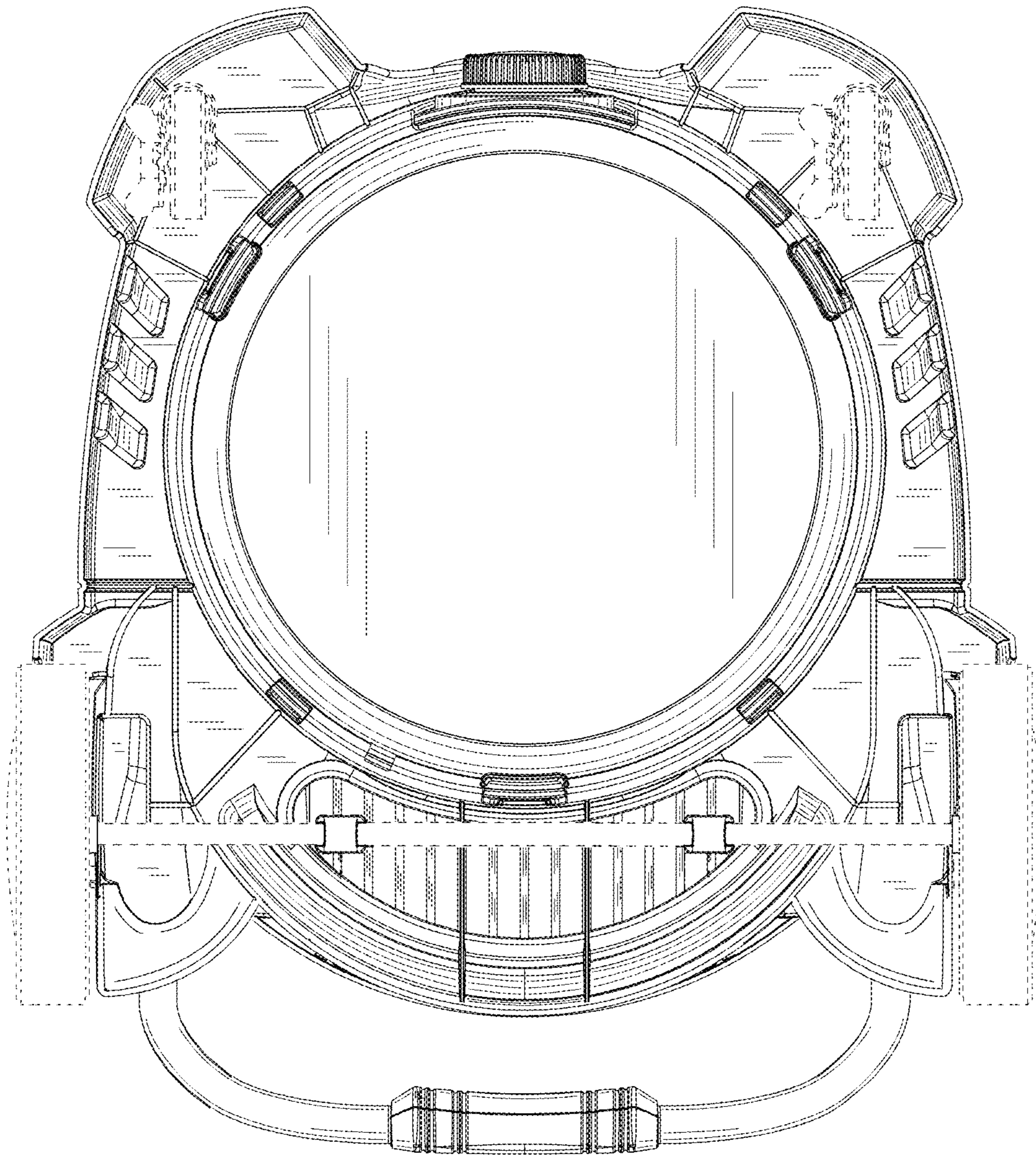

FIG. 14