



US00D806331S

(12) **United States Design Patent**
Chu et al.

(10) **Patent No.:** **US D806,331 S**

(45) **Date of Patent:** **** Dec. 26, 2017**

(54) **HAND-HELD VACUUM CLEANER**

(71) Applicant: **BISSELL Homecare, Inc.**, Grand Rapids, MI (US)

(72) Inventors: **Lawrence Chun-Hei Chu**, Shenzhen (CN); **Jing Yang**, Zhongshan (CN)

(73) Assignee: **BISSELL Homecare, Inc.**, Grand Rapids, MI (US)

(**) Term: **15 Years**

(21) Appl. No.: **29/573,083**

(22) Filed: **Aug. 2, 2016**

(51) **LOC (10) Cl.** **15-05**

(52) **U.S. Cl.**
USPC **D32/18**

(58) **Field of Classification Search**
USPC D32/17-18, 21, 31
CPC A47L 5/24; A47L 5/28; A47L 7/0038
See application file for complete search history.

(56) **References Cited**

U.S. PATENT DOCUMENTS

D356,191 S *	3/1995	Phelan	D32/18
D398,425 S *	9/1998	Hudson	D32/18
D404,857 S *	1/1999	Ng	D32/18
D432,743 S *	10/2000	Santiago	D32/18
D448,894 S *	10/2001	Yuen	D32/18
D456,960 S *	5/2002	Vandenbelt	D32/18

D564,151 S *	3/2008	Fjellman	D32/18
D569,059 S *	5/2008	Stratford	D32/18
D608,511 S *	1/2010	Okuda	D32/18
D648,083 S *	11/2011	Luyckx	D32/18
D660,528 S *	5/2012	Okuda	D32/18
D696,825 S *	12/2013	Sweeney	D32/18
D720,102 S *	12/2014	Gu	D32/18

* cited by examiner

Primary Examiner — Ruth McInroy

(74) *Attorney, Agent, or Firm* — McGarry Bair PC

(57) **CLAIM**

The ornamental design for a hand-held vacuum cleaner, as shown and described.

DESCRIPTION

FIG. 1 is a front, right perspective view of a hand-held vacuum cleaner showing our new design;
FIG. 2 is a top view thereof;
FIG. 3 is a bottom view thereof;
FIG. 4 is a left side view thereof;
FIG. 5 is a right side view thereof;
FIG. 6 is a rear view thereof; and,
FIG. 7 is a front view thereof.

The details shown in broken lines form no part of the claimed design.

The broken lines in the figures illustrate the boundaries of the claim, and form no part of the claimed design.

1 Claim, 4 Drawing Sheets

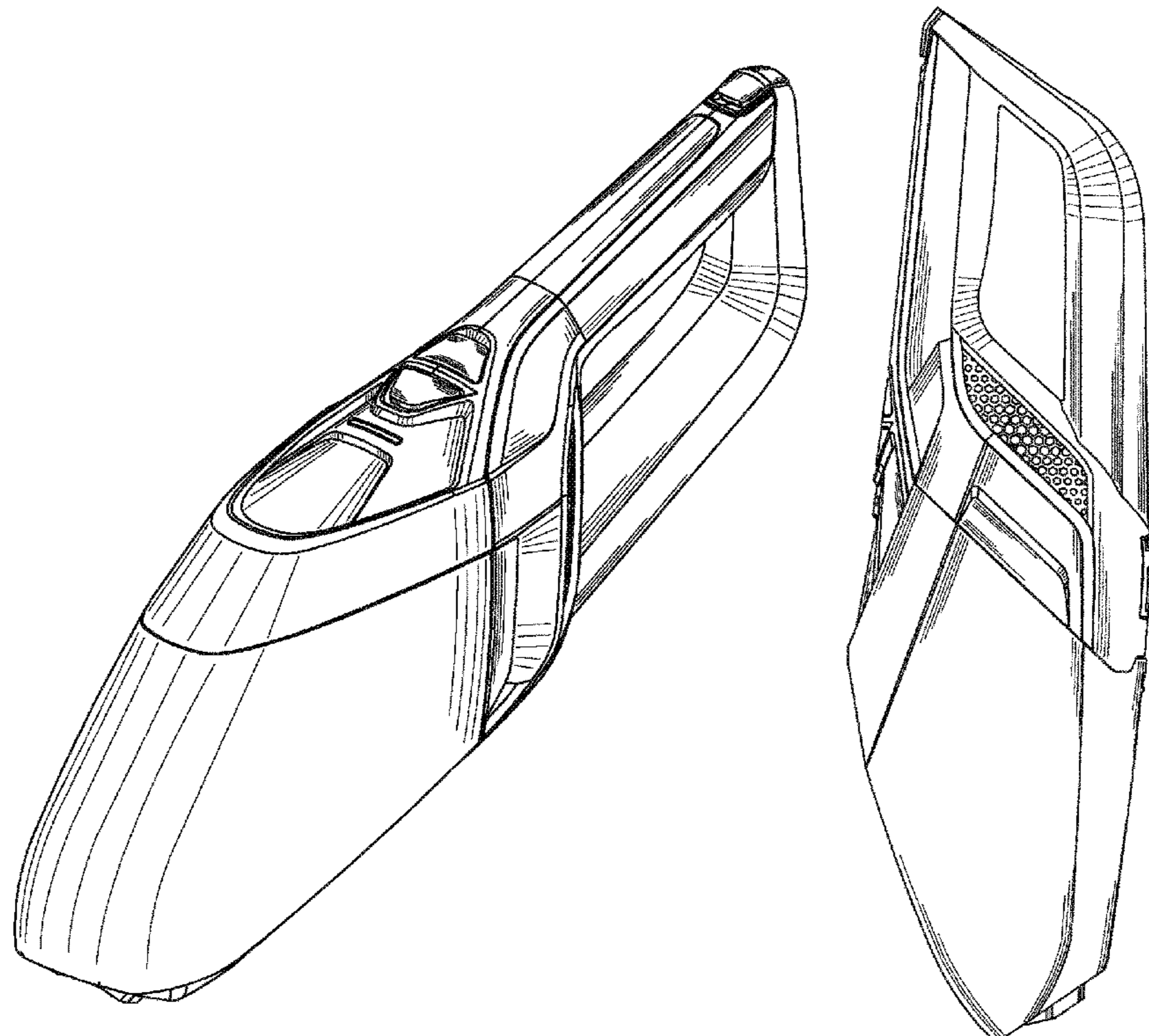

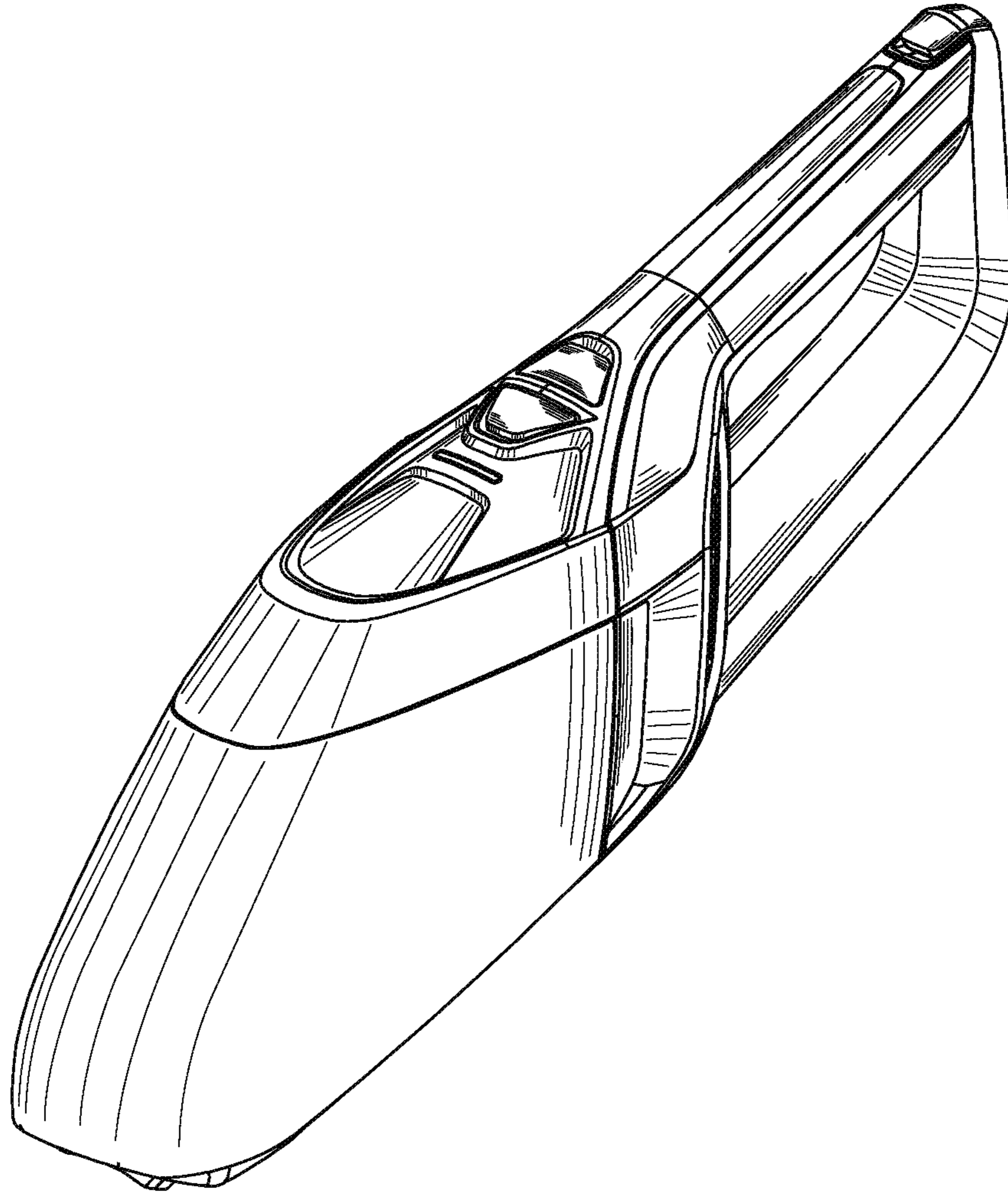

FIG. 1

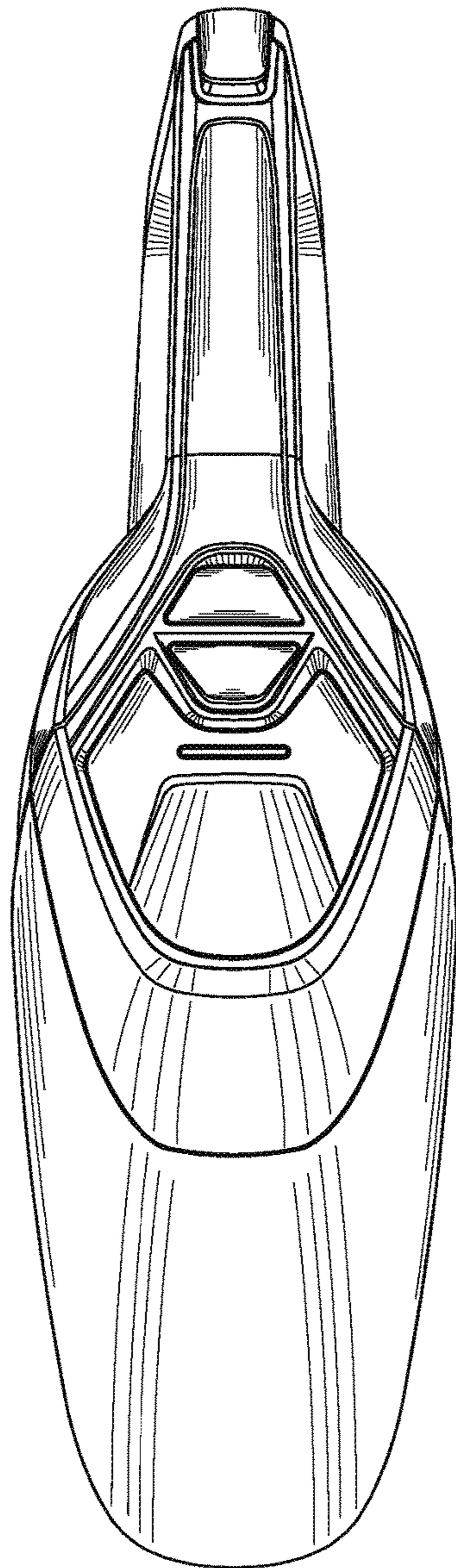

FIG. 2

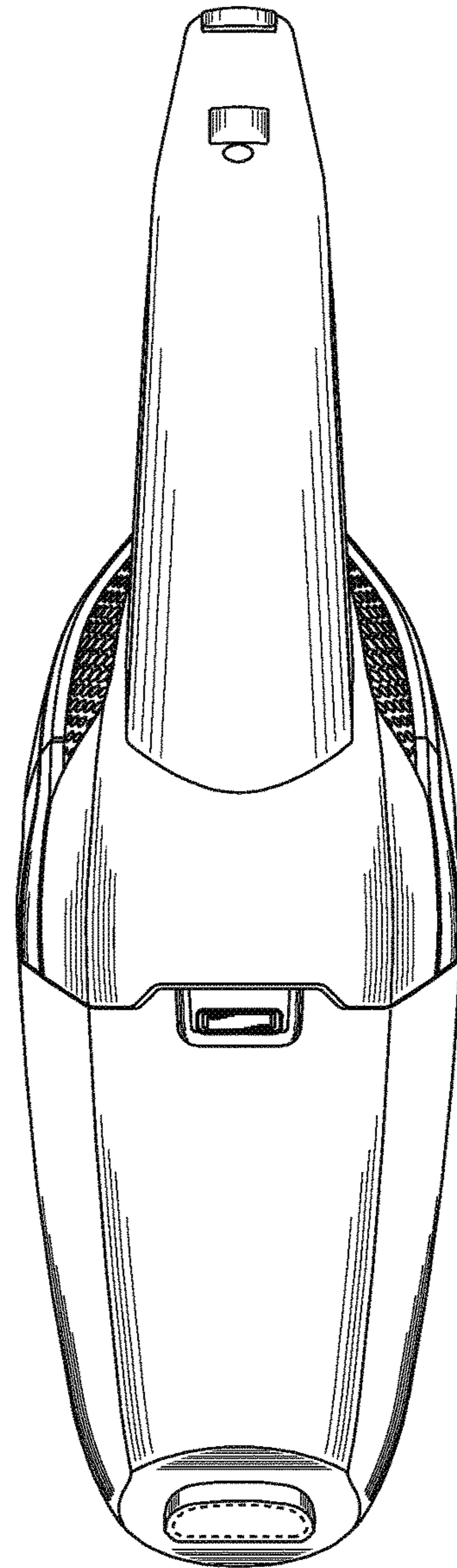

FIG. 3

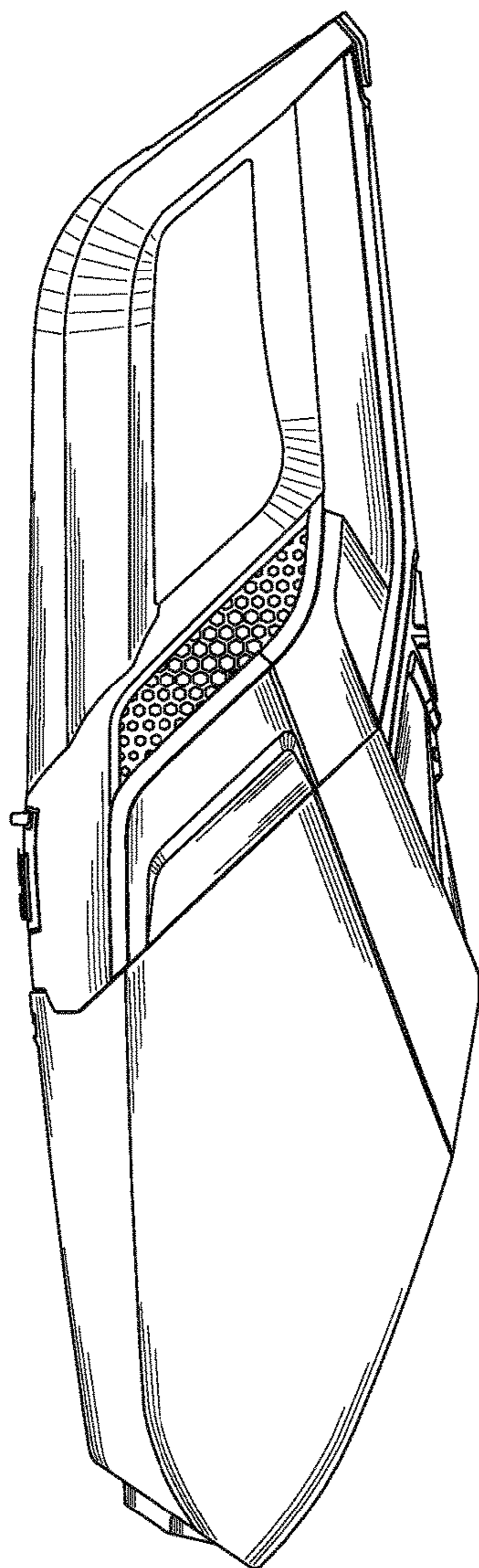

FIG. 4

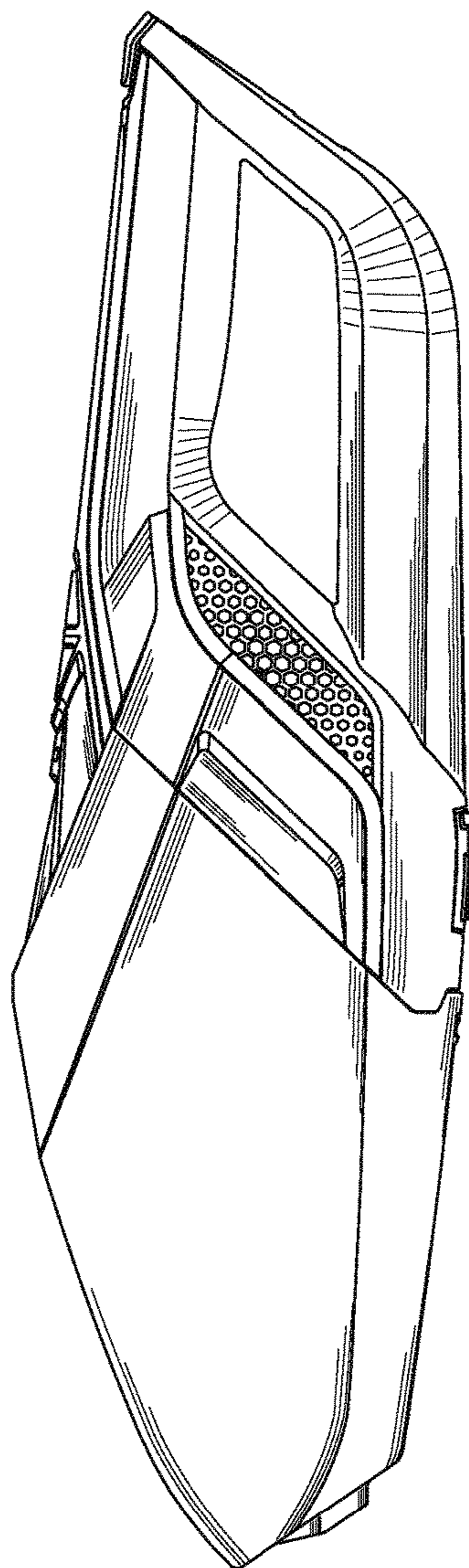

FIG. 5

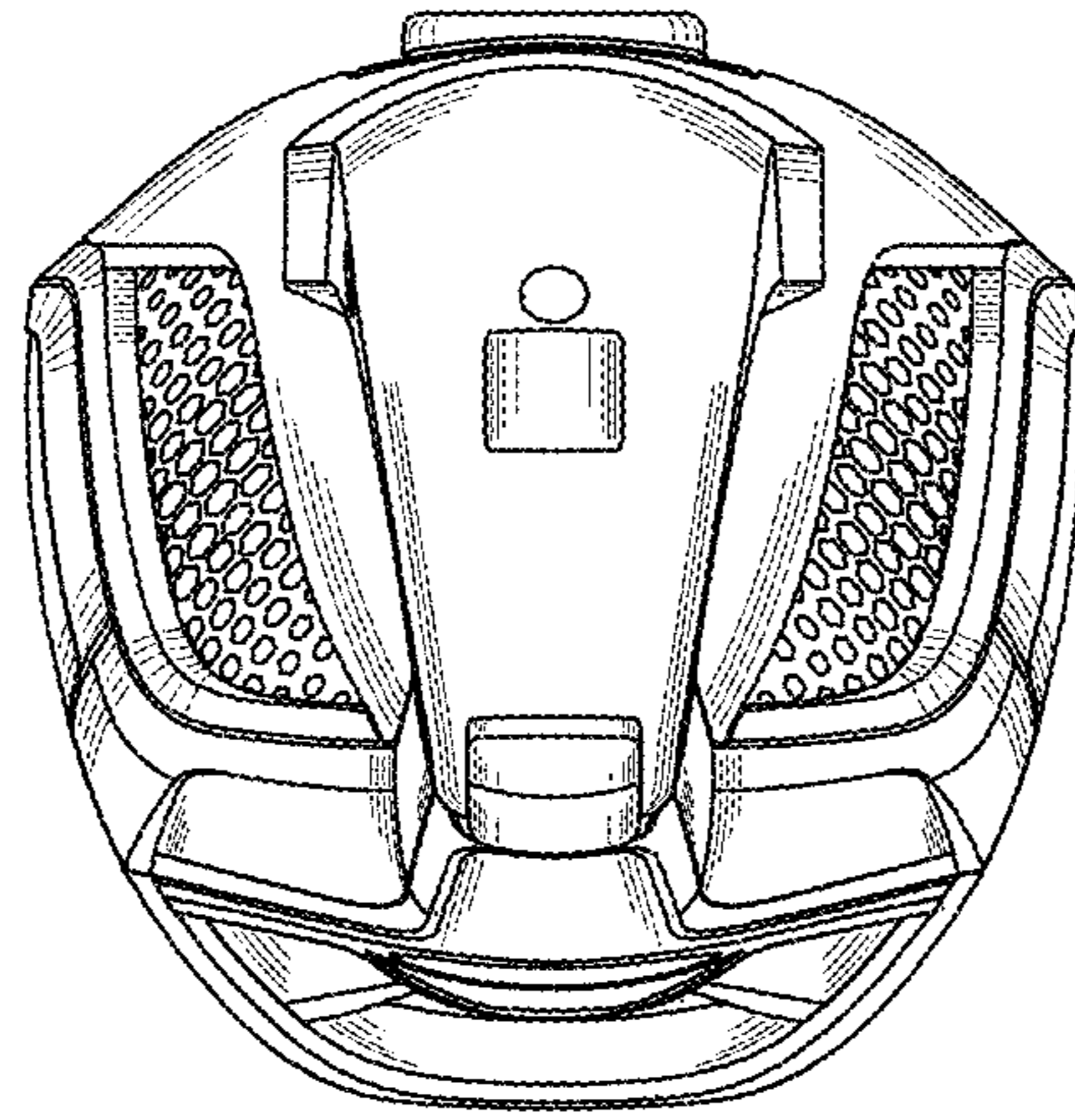

FIG. 6

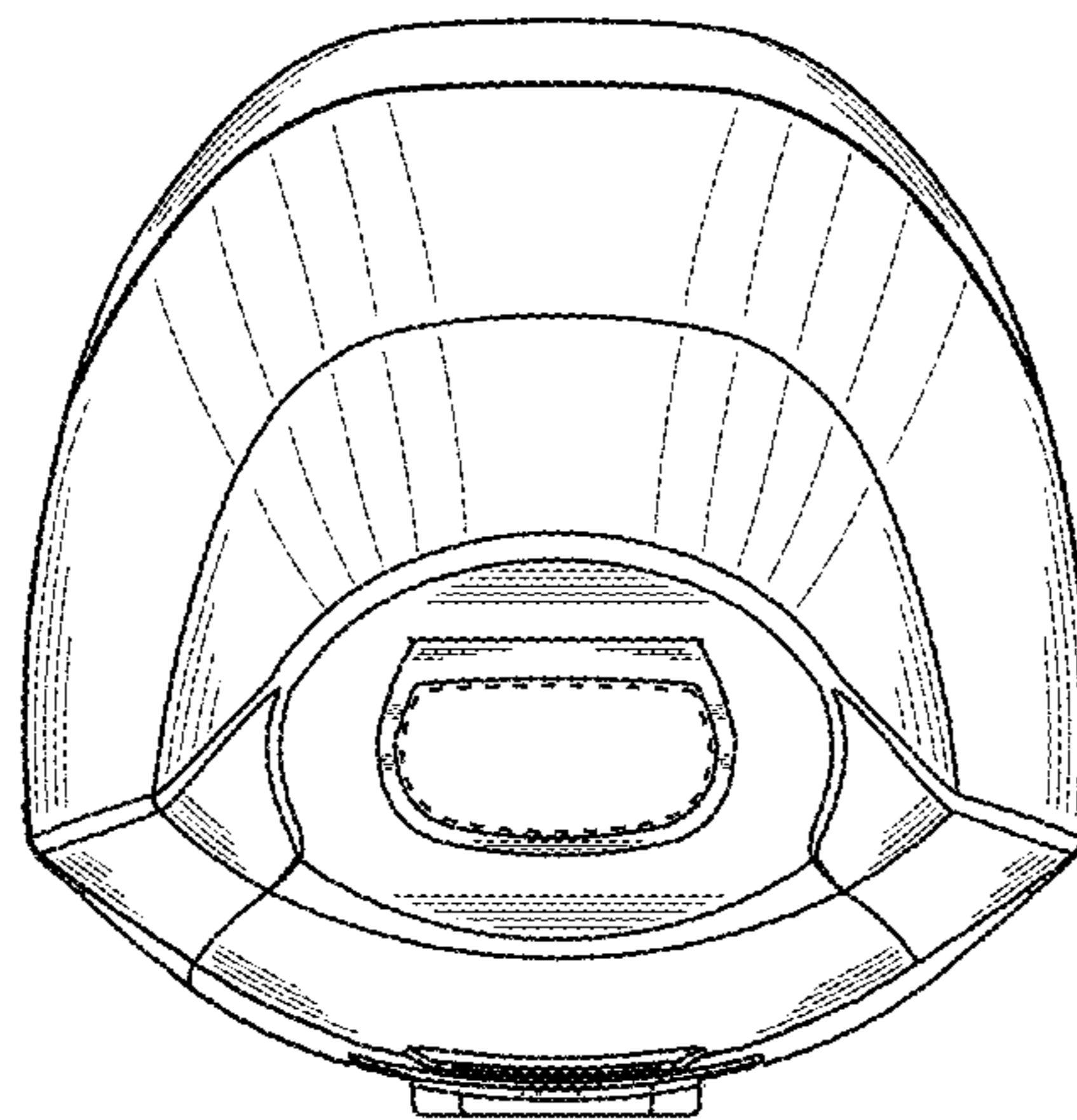

FIG. 7