



US00D806262S

(12) **United States Design Patent**
Middleton-Davis et al.

(10) **Patent No.:** **US D806,262 S**

(45) **Date of Patent:** **** Dec. 26, 2017**

(54) **WESTERN BLOT PROCESSOR**

D717,465 S * 11/2014 Muraoka D24/216
D738,527 S * 9/2015 Benarieh D24/233
D751,728 S * 3/2016 Latorraca D24/232

(71) Applicant: **Cytoskeleton, Inc.**, Denver, CO (US)

* cited by examiner

(72) Inventors: **Ashley Stuart Middleton-Davis**,
Denver, CO (US); **Kim Maria**
Middleton-Davis, Denver, CO (US)

Primary Examiner — Anhdao Doan

(73) Assignee: **Cytoskeleton, Inc.**, Denver, CO (US)

(74) *Attorney, Agent, or Firm* — Stradley Ronon Stevens
& Young, LLP

(**) Term: **15 Years**

(57) **CLAIM**

(21) Appl. No.: **29/505,138**

The ornamental design for a western blot processor, as shown and described.

(22) Filed: **Jun. 12, 2015**

DESCRIPTION

(51) **LOC (10) Cl.** **24-01**

(52) **U.S. Cl.**

USPC **D24/232**

(58) **Field of Classification Search**

USPC D24/216–219, 231, 232, 233, 107, 169,
D24/186; D10/81

CPC G01N 2035/00306; G01N 2035/00326;
G01N 2035/00336; G01N 35/1085; G01N
2021/6432; C12Q 1/6869; C12Q 1/6806

See application file for complete search history.

FIG. 1 shows a front left perspective view of the western blot processor;

FIG. 2 shows a front right perspective view of the western blot processor;

FIG. 3 shows a left side perspective view of the western blot processor;

FIG. 4 shows a right side perspective view of the western blot processor;

FIG. 5 shows a right side view of the western blot processor; and,

FIG. 6 shows a front elevation view of the western blot processor.

The broken lines in the drawing views are included for the purpose of illustrating a portion of the western blot processor that forms no part of the claimed design.

(56) **References Cited**

U.S. PATENT DOCUMENTS

5,567,595 A * 10/1996 Kok G01N 33/54366
422/536

6,194,160 B1 * 2/2001 Levin B01L 3/50255
422/527

1 Claim, 6 Drawing Sheets

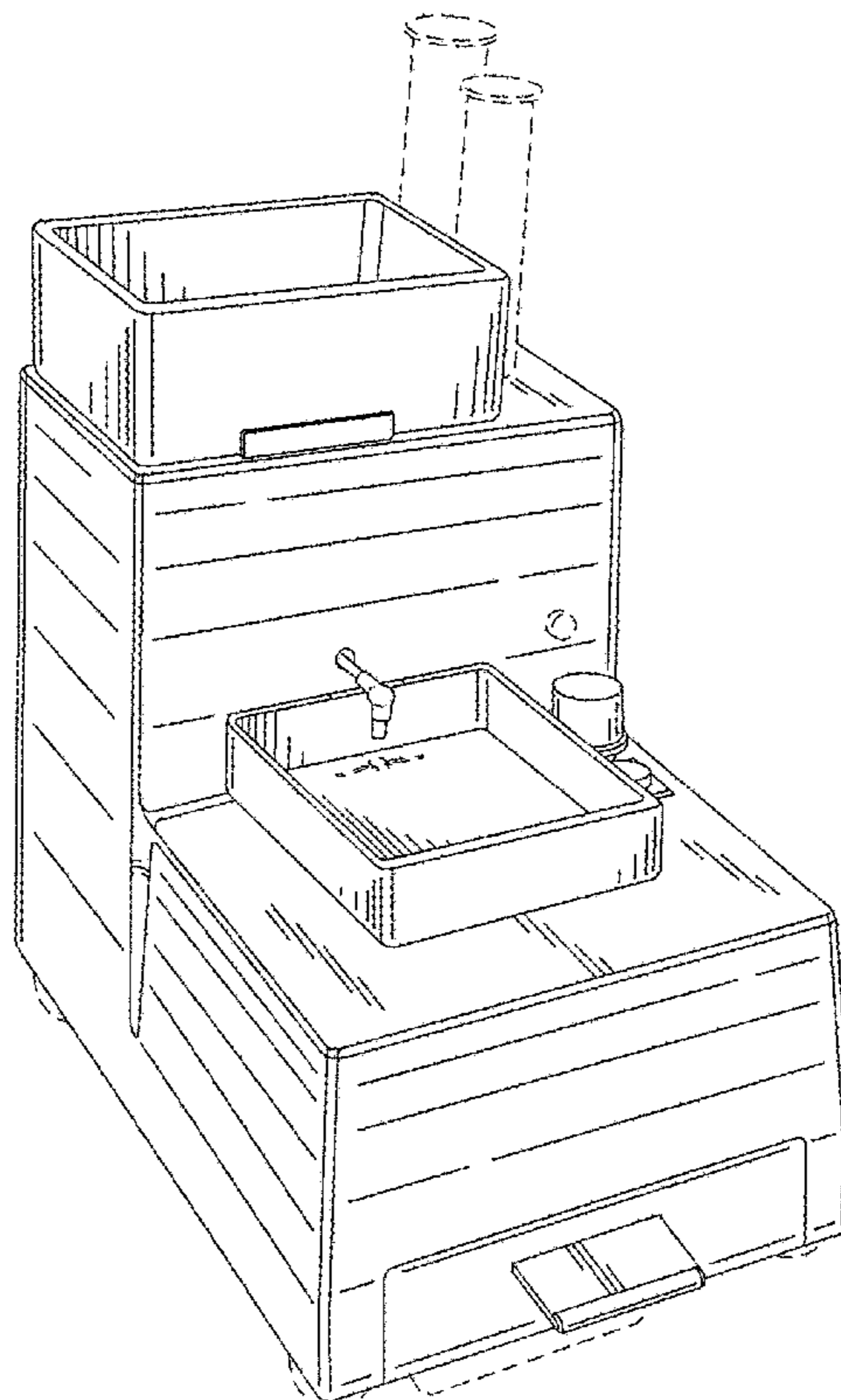

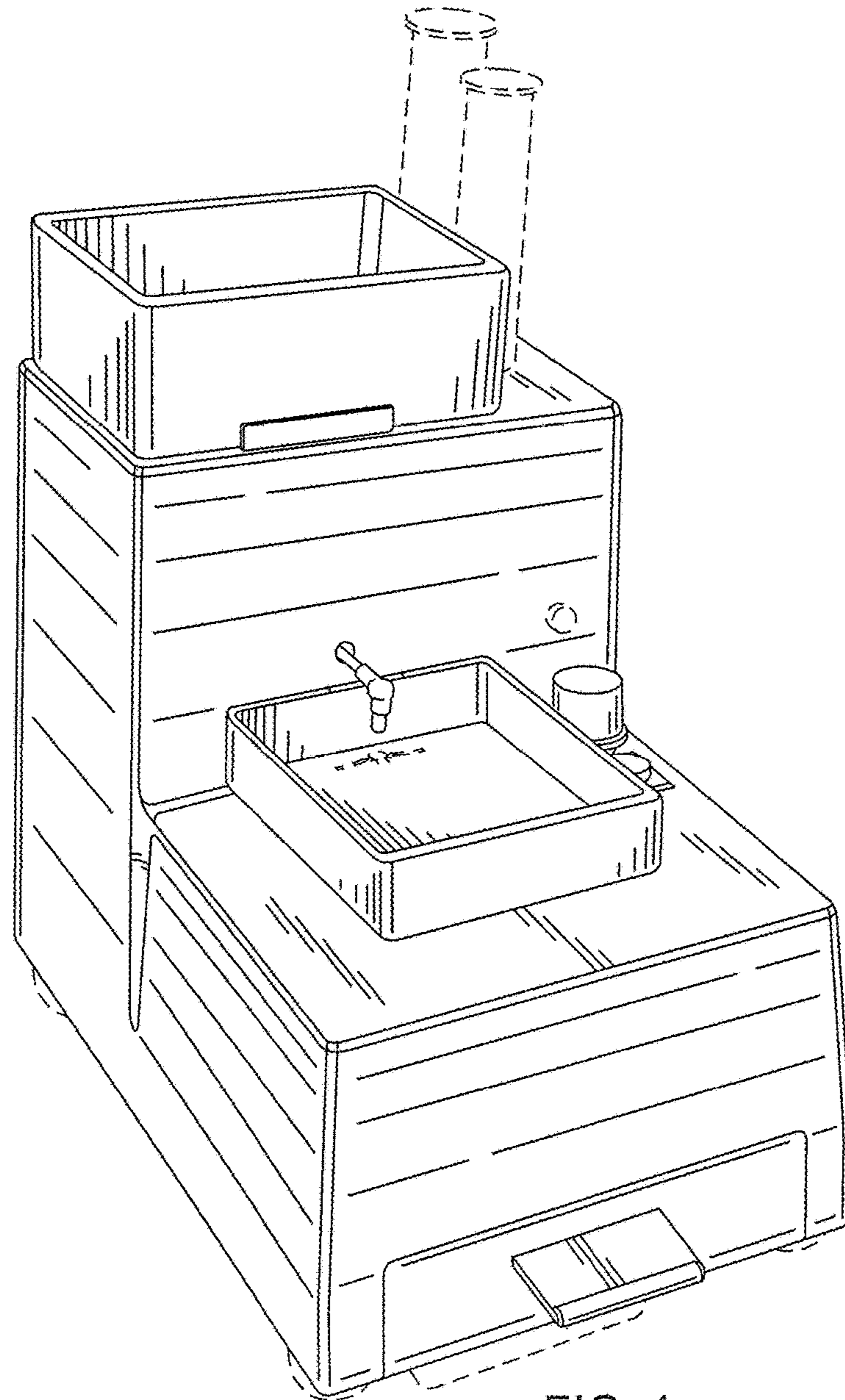

FIG. 1

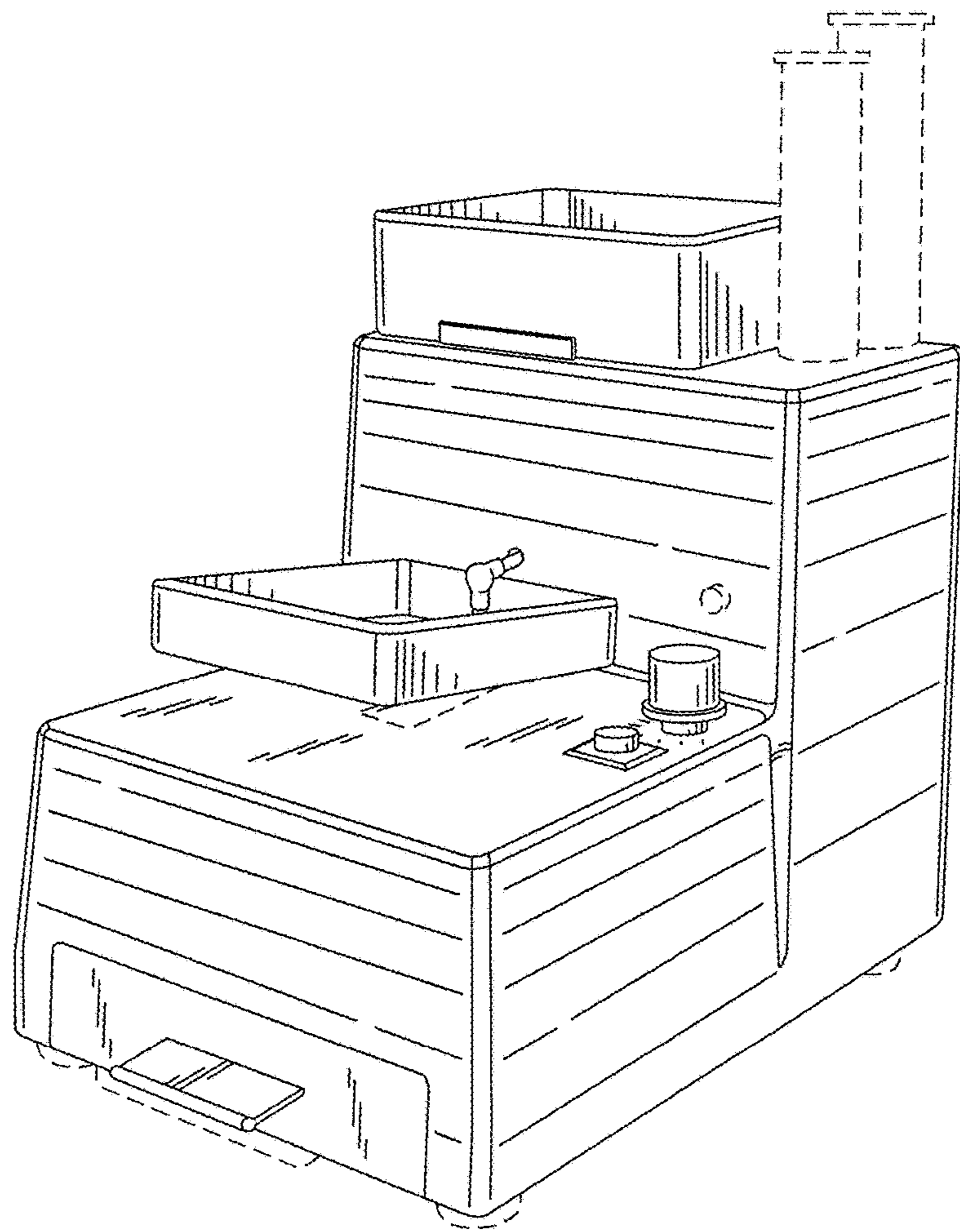

FIG. 2

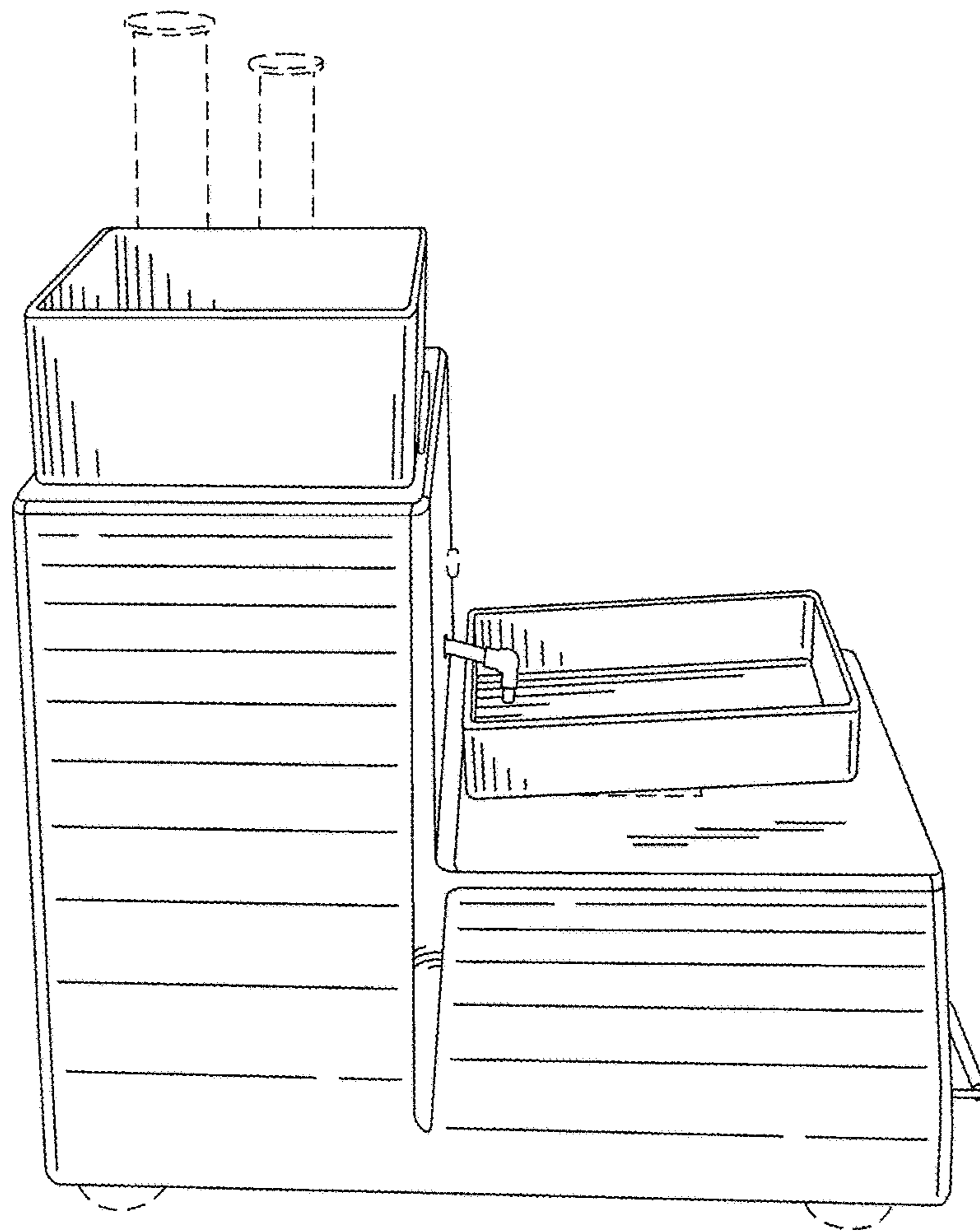

FIG. 3

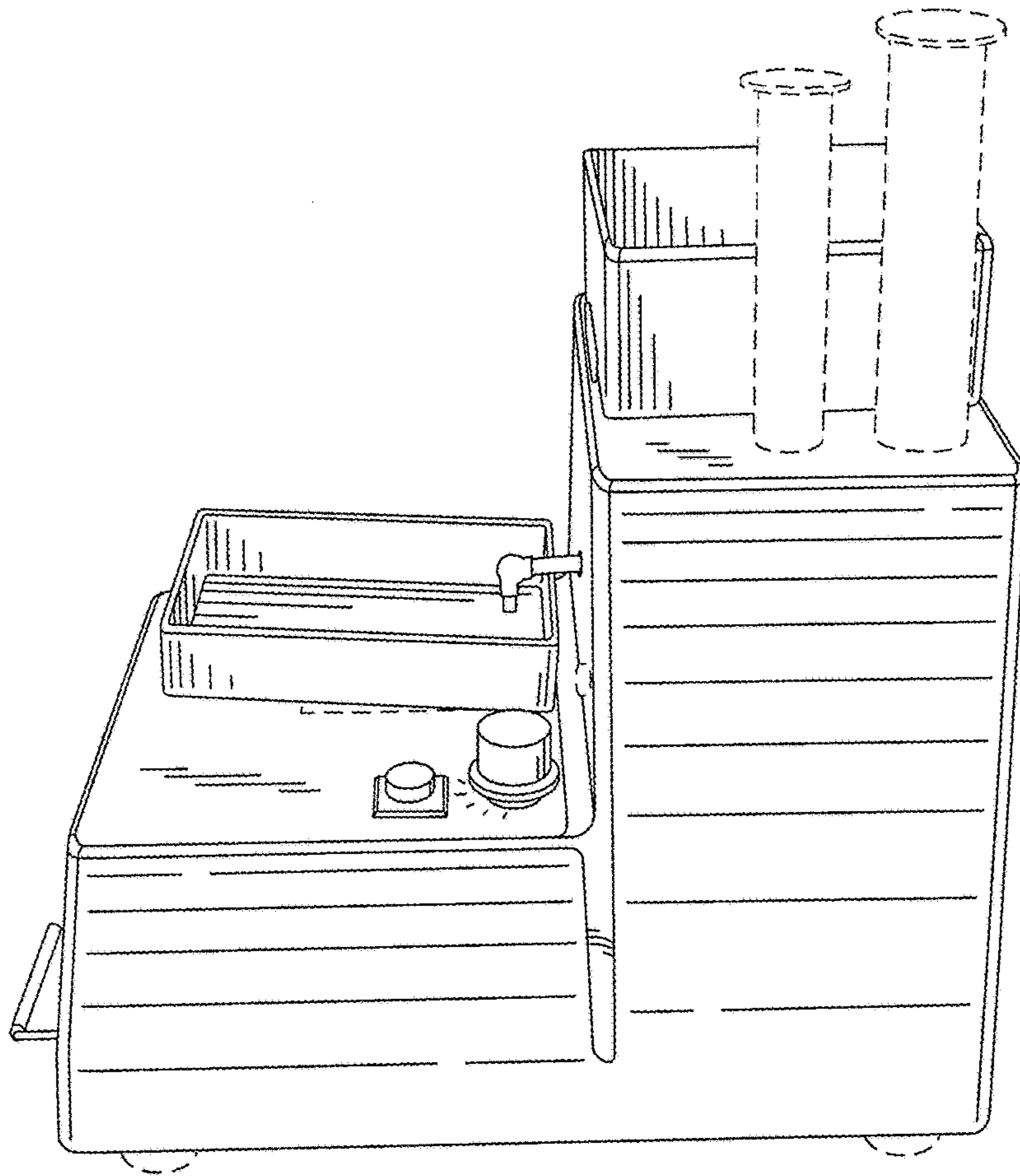

FIG. 4

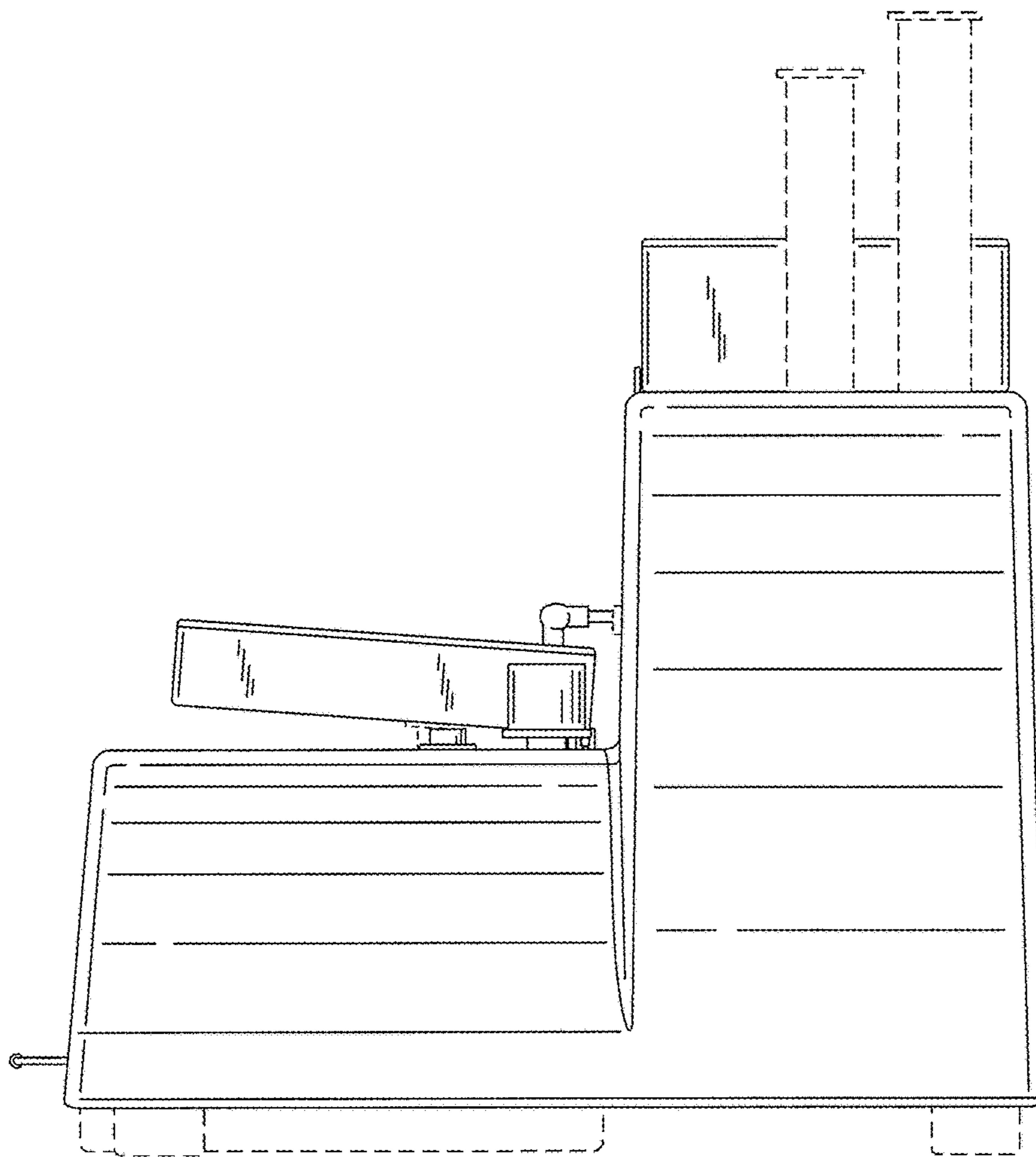

FIG. 5

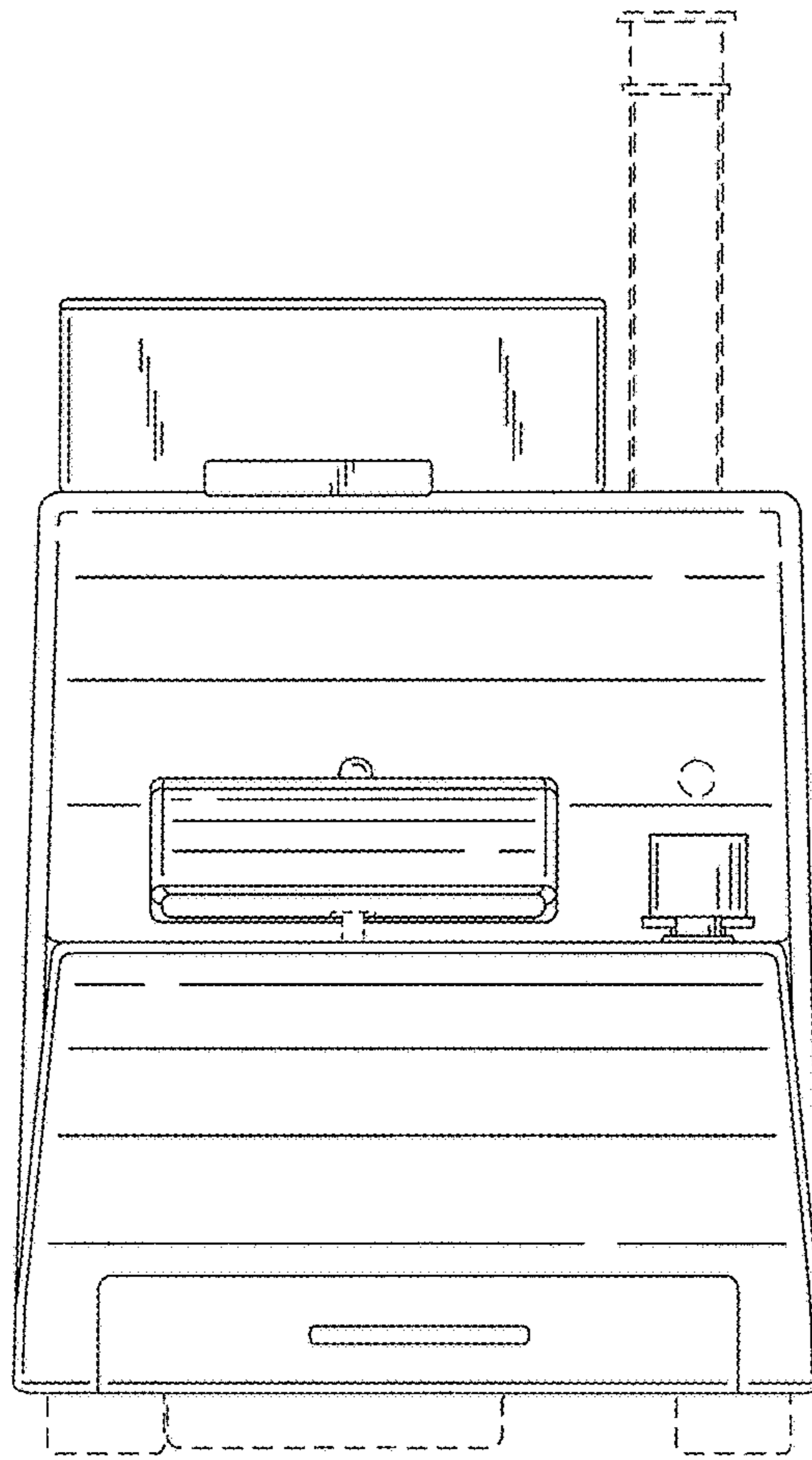

FIG. 6