



US00D806235S

(12) **United States Design Patent** (10) **Patent No.:** **US D806,235 S**
Costello et al. (45) **Date of Patent:** **** Dec. 26, 2017**

(54) **INJECTOR DEVICE**

FOREIGN PATENT DOCUMENTS

(71) Applicant: **West Pharmaceutical Services, Inc.**,
Exton, PA (US)

WO WO2011090956 A2 7/2011
WO WO2012032411 A2 3/2012

(Continued)

(72) Inventors: **Brian Costello**, Whitehouse Station, NJ
(US); **Raymond Protasiewicz**,
Whippany, NJ (US)

OTHER PUBLICATIONS

(73) Assignee: **West Pharmaceutical Services, Inc.**,
Exton, PA (US)

Reynolds, "Integrated Solutions for the Delivery of High-Volume
Biologics", West Pharmaceutical Services, www.ondrugdelivery.
com, Copyright 2014, 4 pages.

(Continued)

(**) Term: **15 Years**

Primary Examiner — David G Muller

(21) Appl. No.: **29/582,292**

Assistant Examiner — Nathan M Johnston

(22) Filed: **Oct. 26, 2016**

(74) *Attorney, Agent, or Firm* — Baker & Hostetler LLP;
Gregory A. Grissett, Esq.

(51) **LOC (10) Cl.** **24-02**

(52) **U.S. Cl.**
USPC **D24/113**

(57) **CLAIM**

(58) **Field of Classification Search**
USPC D24/112–114, 133, 186, 104, 130, 127,
D24/176, 108, 110, 220; 606/181, 185;
604/232, 187, 158, 164.08, 192, 263, 163,
604/181, 184, 198, 227, 275, 890.1,
604/168.01; D9/414, 424, 417, 426
CPC A61M 2005/14252; A61M 2005/1581;
A61M 5/14248; A61M 2005/14513;
A61M 2005/206
See application file for complete search history.

The design of an injector device, as shown and described.

DESCRIPTION

(56) **References Cited**

U.S. PATENT DOCUMENTS

D369,864 S 5/1996 Petersen
D370,011 S * 5/1996 Lindeman D14/137
D389,139 S * 1/1998 Oross D14/137
D421,902 S 3/2000 Hill
6,186,982 B1 2/2001 Gross et al.
D443,508 S * 6/2001 Braaten D9/734
D445,496 S 7/2001 Anderson
6,500,150 B1 12/2002 Gross et al.
D471,274 S 3/2003 Diaz et al.

FIG. 1 is a top, front, right perspective view of an injector
device showing our new design;
FIG. 2 is a front elevation view thereof;
FIG. 3 is a rear plan elevation view thereof;
FIG. 4 is a top plan view thereof;
FIG. 5 is a bottom plan view thereof.
FIG. 6 is a left side elevation view thereof; and,
FIG. 7 is a right side elevation view thereof.
The dashed line portion of the drawings is included to show
unclaimed subject matter only for the purpose of illustrating
environment and forms no part of the claimed design. The
dash-dot line portions in the drawings define a boundary of
the claimed design and form part thereof.
In a preferred embodiment, the nature of the design is an
injector device for delivering pharmaceutical agents.

(Continued)

1 Claim, 7 Drawing Sheets

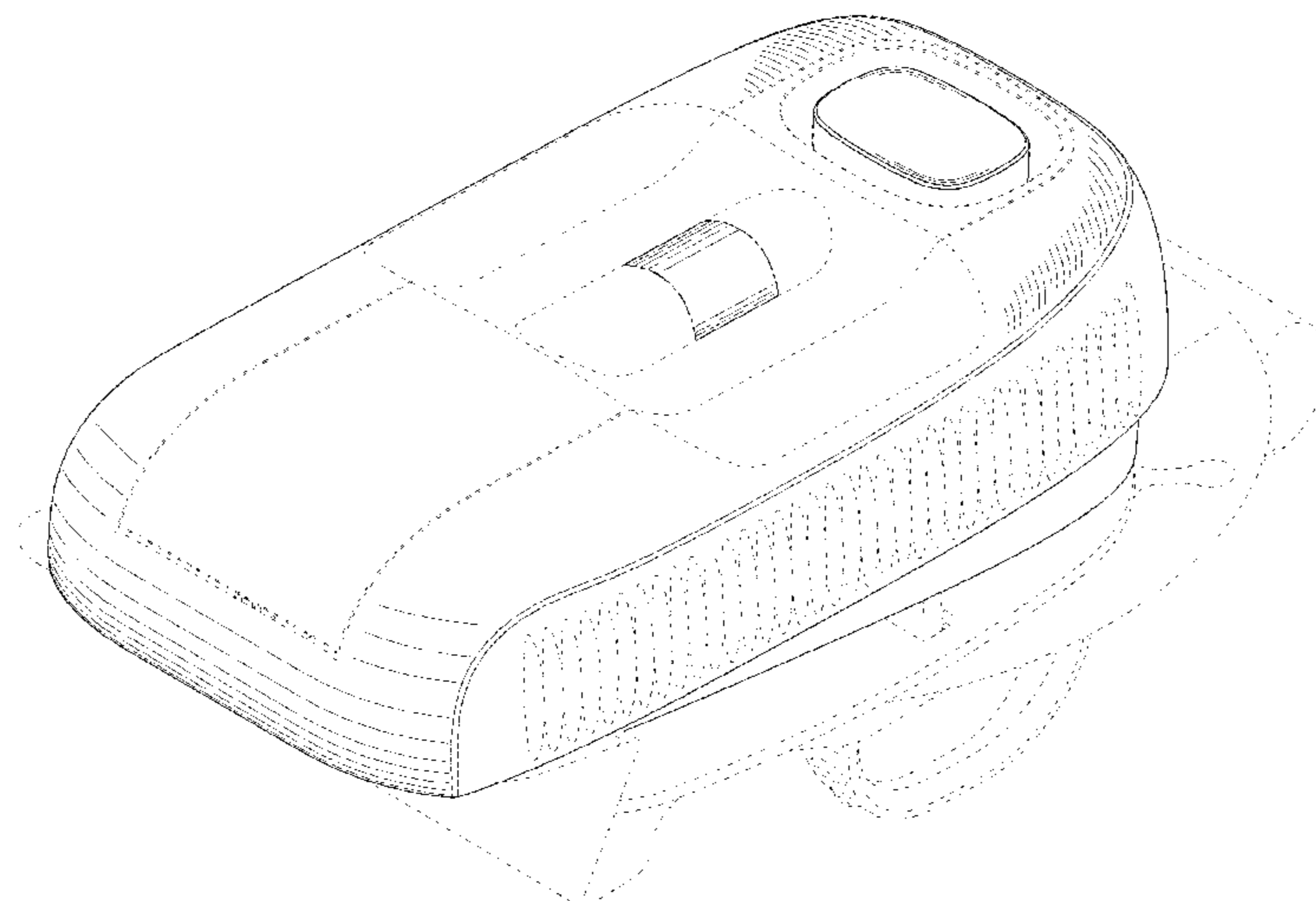

(56)

References Cited

U.S. PATENT DOCUMENTS

6,530,900 B1 3/2003 Daily et al.
D474,543 S 5/2003 Lee et al.
6,613,015 B2 9/2003 Sandstrom et al.
6,800,071 B1 10/2004 McConnell et al.
6,843,782 B2 1/2005 Gross et al.
D544,092 S * 6/2007 Lewis D24/108
D619,338 S 7/2010 Teichert et al.
D622,685 S * 8/2010 Garra D14/137
7,780,636 B2 8/2010 Radmer et al.
7,967,795 B1 6/2011 Cabiri
D640,920 S 7/2011 Giraud et al.
D646,159 S 10/2011 Bellamah et al.
8,152,779 B2 4/2012 Cabiri
8,157,769 B2 4/2012 Cabiri
8,210,172 B2 * 7/2012 Crowder A61M 15/0045
128/200.24
8,303,549 B2 11/2012 Mejlhede et al.
8,313,467 B2 11/2012 Chong et al.
8,348,898 B2 1/2013 Cabiri
8,393,357 B2 3/2013 Chong et al.
D684,686 S 6/2013 Cronenberg
D685,083 S * 6/2013 Schneider D24/108
D685,084 S * 6/2013 Guarraia D24/108
8,465,455 B2 6/2013 Cabiri
D687,140 S 7/2013 Guarraia et al.
D687,141 S 7/2013 Schneider et al.
D687,536 S * 8/2013 Guarraia D24/108
D688,784 S 8/2013 Schneider et al.
D702,834 S 4/2014 Norton et al.
D714,266 S * 9/2014 Okamura D14/191
8,882,711 B2 11/2014 Saulenas et al.
D722,870 S 2/2015 Fohner et al.
8,986,250 B2 3/2015 Beebe et al.
9,011,164 B2 4/2015 Filman et al.
9,173,997 B2 11/2015 Gross et al.
D745,661 S 12/2015 Collins et al.
D753,810 S 4/2016 Chang
D755,950 S 5/2016 Meliniotis et al.
D760,374 S 6/2016 Nagar et al.
9,373,269 B2 6/2016 Bergman et al.
D764,047 S 8/2016 Bjelovuk et al.
9,421,323 B2 8/2016 Cabiri et al.
D769,438 S * 10/2016 Crosby D24/110
D770,037 S 10/2016 Schleicher et al.
9,463,280 B2 10/2016 Cabiri
9,492,614 B2 11/2016 Kamen et al.
D776,262 S 1/2017 Tyce et al.
D776,265 S 1/2017 Tyce et al.
D777,331 S 1/2017 Jayalath et al.
9,656,019 B2 5/2017 Cabiri et al.
2007/0021733 A1 1/2007 Hansen et al.
2008/0215015 A1 9/2008 Cindrich et al.

2009/0093792 A1 4/2009 Gross et al.
2012/0035546 A1 2/2012 Cabiri
2013/0110049 A1 5/2013 Cronenberg et al.
2013/0245596 A1 9/2013 Cabiri et al.
2013/0253472 A1 9/2013 Cabiri
2013/0296799 A1 11/2013 Degtiar et al.
2013/0304021 A1 11/2013 Cabiri et al.
2013/0310753 A1 11/2013 Cabiri
2014/0128815 A1 5/2014 Cabiri et al.
2014/0207067 A1 7/2014 Kamen et al.
2014/0330240 A1 11/2014 Cabiri et al.
2014/0346378 A1 11/2014 Kua et al.
2014/0350459 A1 11/2014 Lanier, Jr. et al.
2015/0011965 A1 1/2015 Cabiri
2015/0157786 A1 6/2015 Sonderegger et al.
2015/0165121 A1 6/2015 Murakami et al.
2015/0250943 A1 * 9/2015 Momose A61M 5/14276
604/151
2015/0306307 A1 * 10/2015 Cole A61M 5/14248
604/508
2015/0359965 A1 12/2015 OConnor et al.
2016/0058941 A1 3/2016 Wu et al.
2016/0082184 A1 3/2016 Hanagan et al.
2016/0121043 A1 5/2016 Weibel
2016/0256352 A1 9/2016 Bar-El et al.
2016/0256353 A1 9/2016 Bar-El et al.
2016/0284239 A1 9/2016 Bergman et al.
2016/0296699 A1 10/2016 Cabiri
2016/0296716 A1 10/2016 Cabiri et al.
2017/0028132 A1 2/2017 Cronenberg et al.

FOREIGN PATENT DOCUMENTS

WO WO2014081411 A1 5/2014
WO WO2016196934 A1 12/2016

OTHER PUBLICATIONS

Amgen Inc., "The Neulasta Onpro Kit", <http://www.neulastahcp.com/neulasta-onpro/>, Copyright 2016, 16 pages.
BD Worldwide, "Self-Injection Systems", <http://www.bd.com/pharmaceuticals/products/self-injection/patch-injectors.asp>, Copyright 2017, 2 pages.
OndrugDelivery, "Wearable Injectors", Sep. 19, 2016 Issue No. 70, 48 pages.
Sensile Medical AG, "SensePatch", https://www.sensile-medical.com/assets/data-sheet_5002_senspatch.pdf, 2017, 2 pages.
Unilife Corporation, "Wearable Injectors", <http://www.unilife.com/product-platforms/WearableInjectors>, Copyright 2016, 3 pages.
West Pharmaceutical Services, Inc. "SmartDose Platform" <http://www.westpharma.com/products/self-injection-platforms/smartdoes>, Copyright 2017, 3 pages.

* cited by examiner

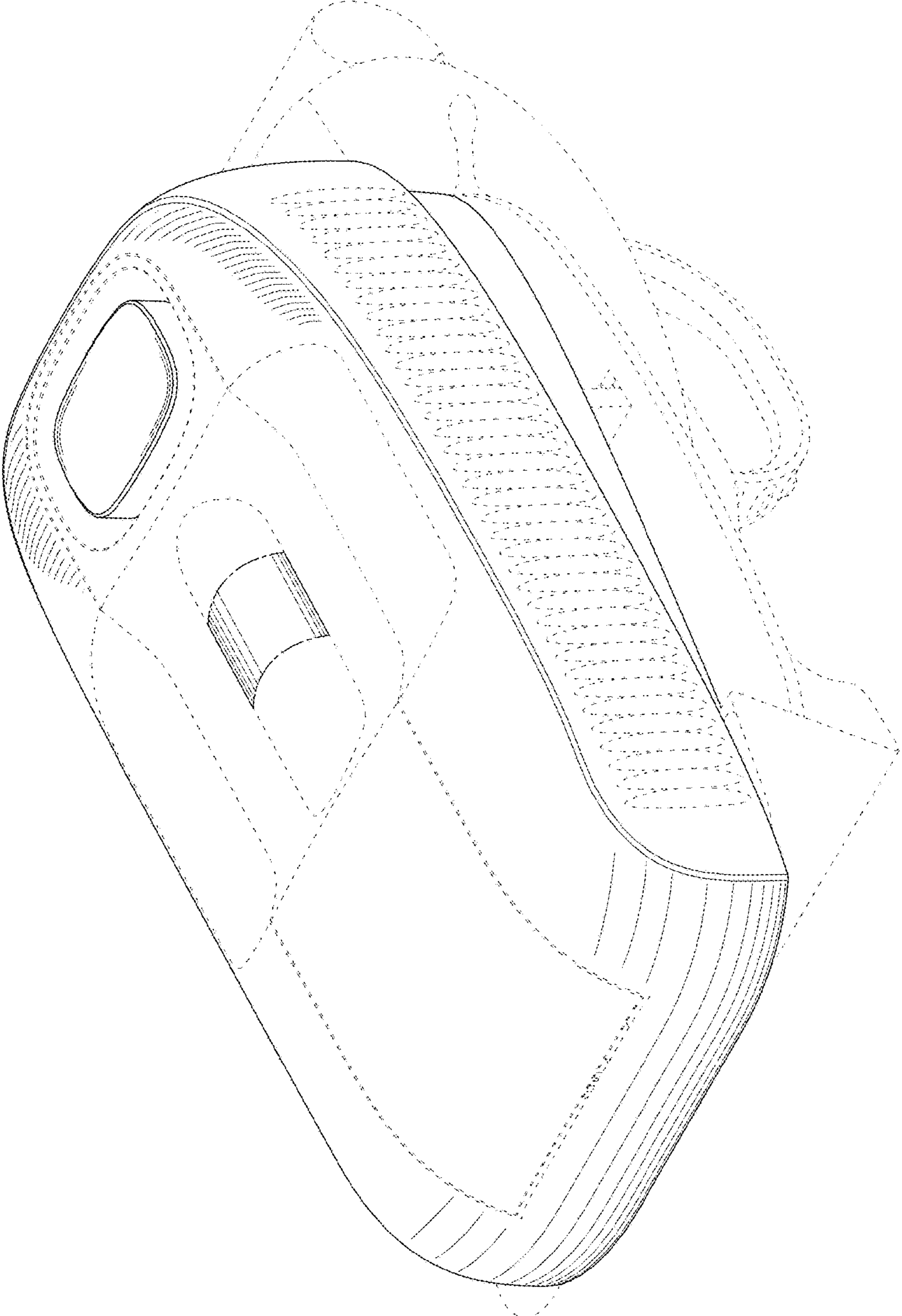

FIG. 1

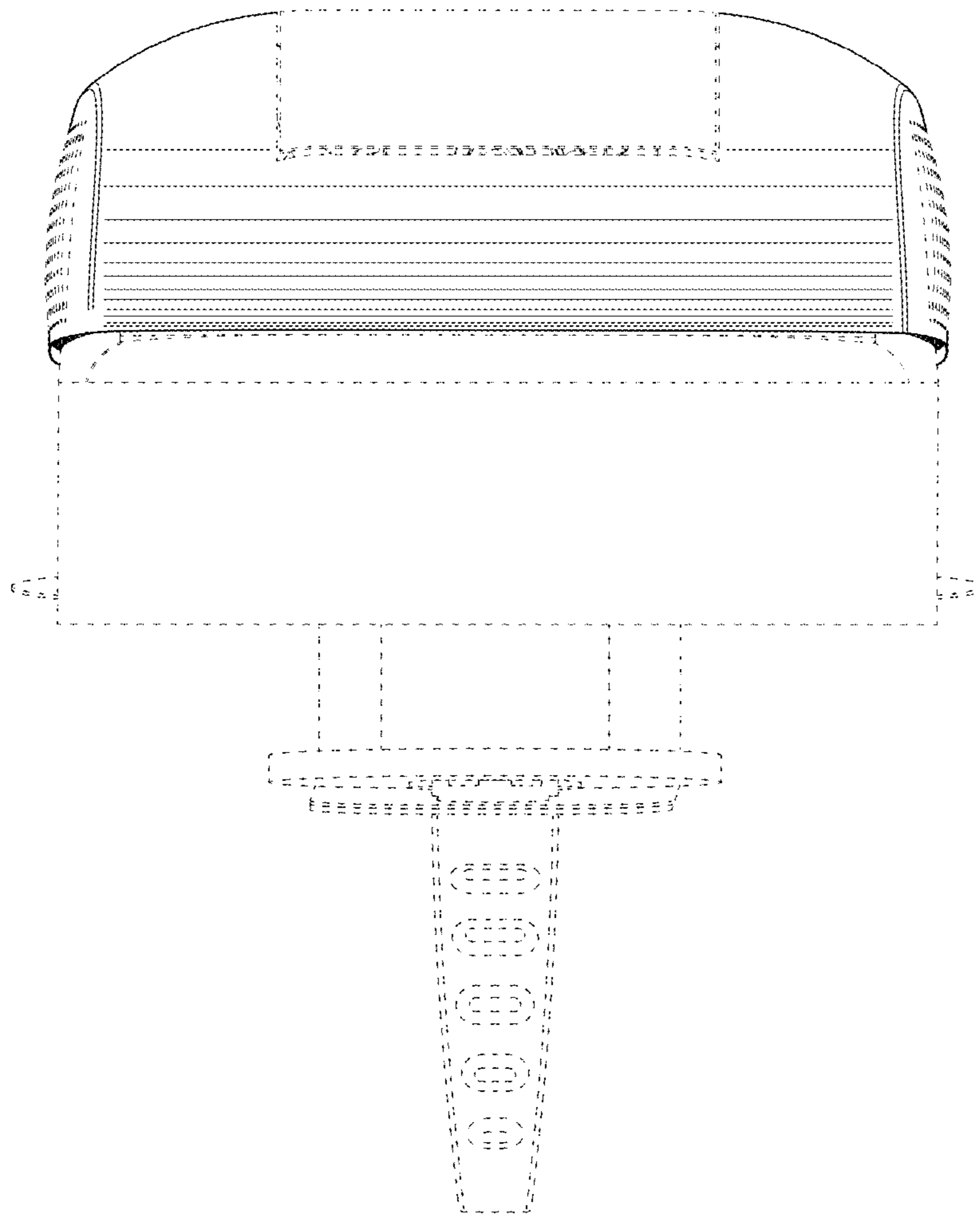

FIG. 2

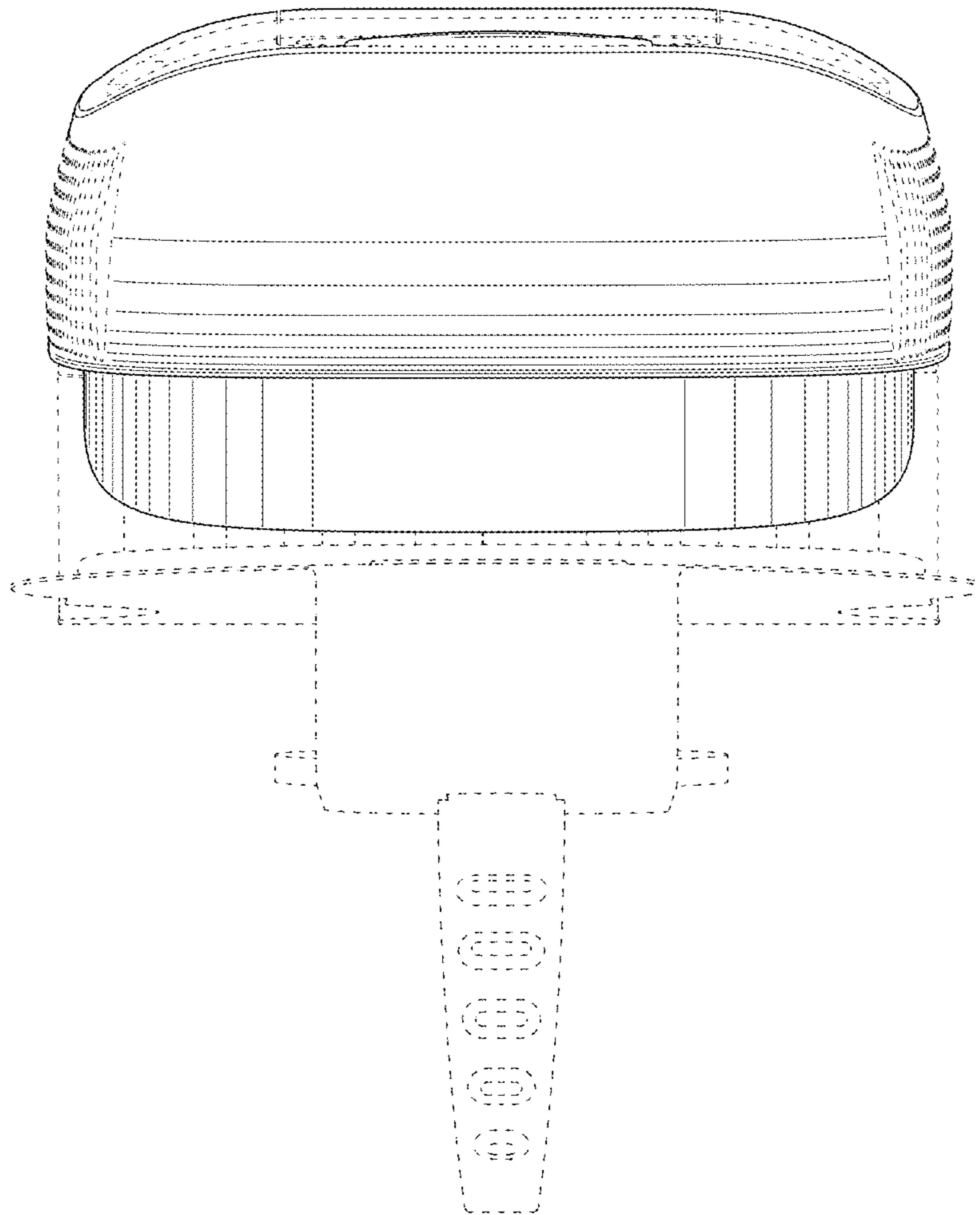

FIG. 3

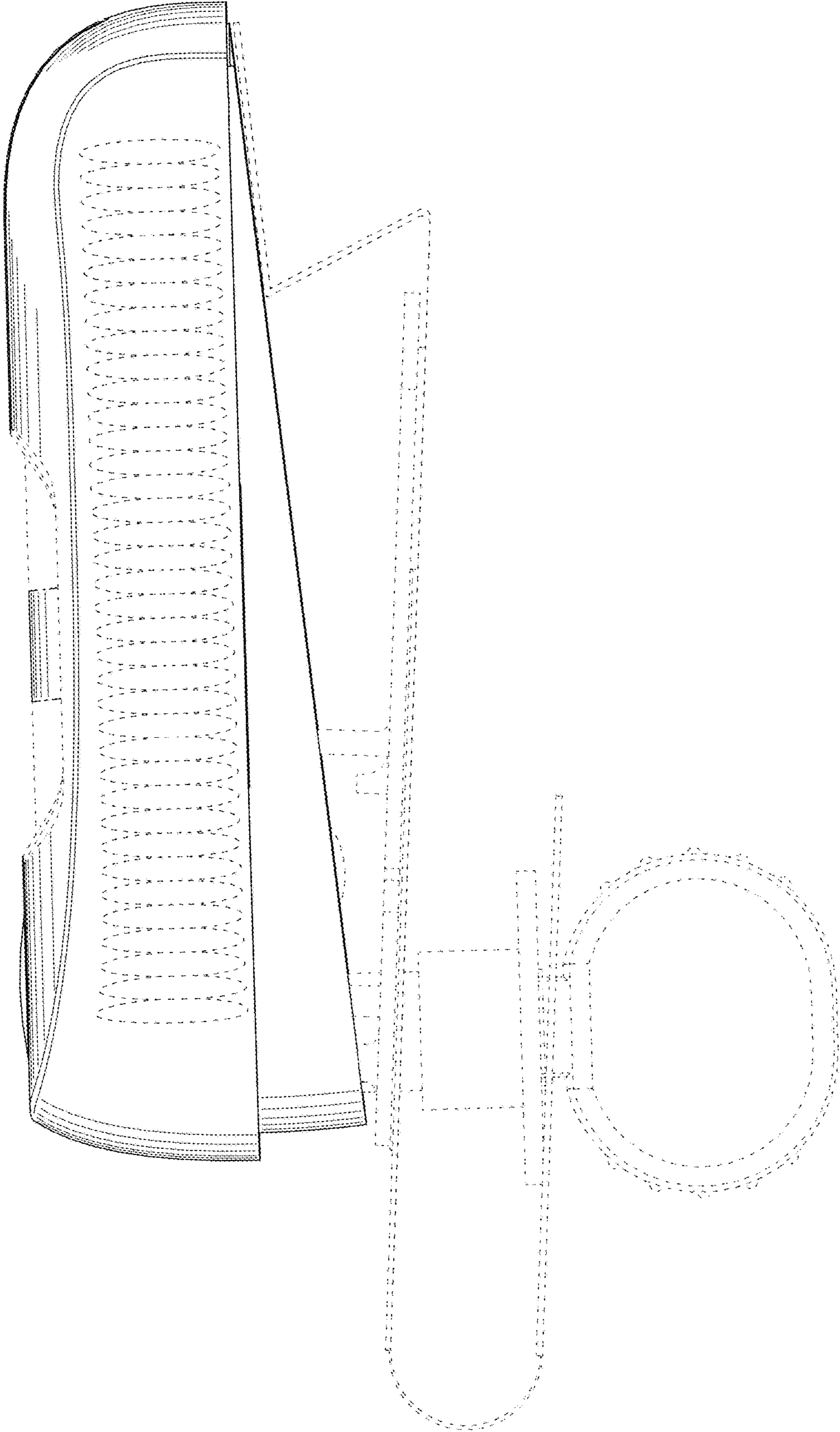

FIG. 4

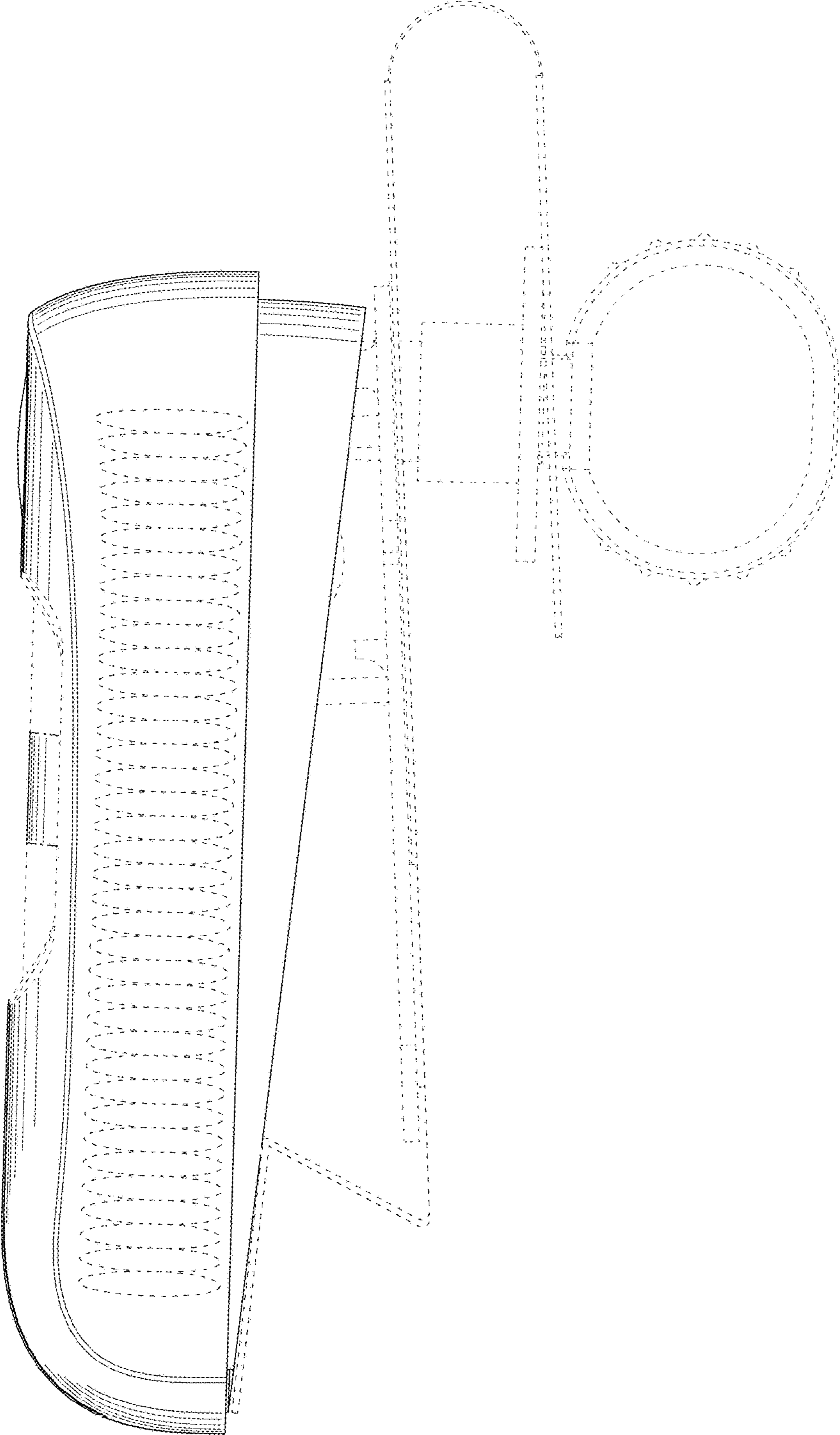

FIG. 5

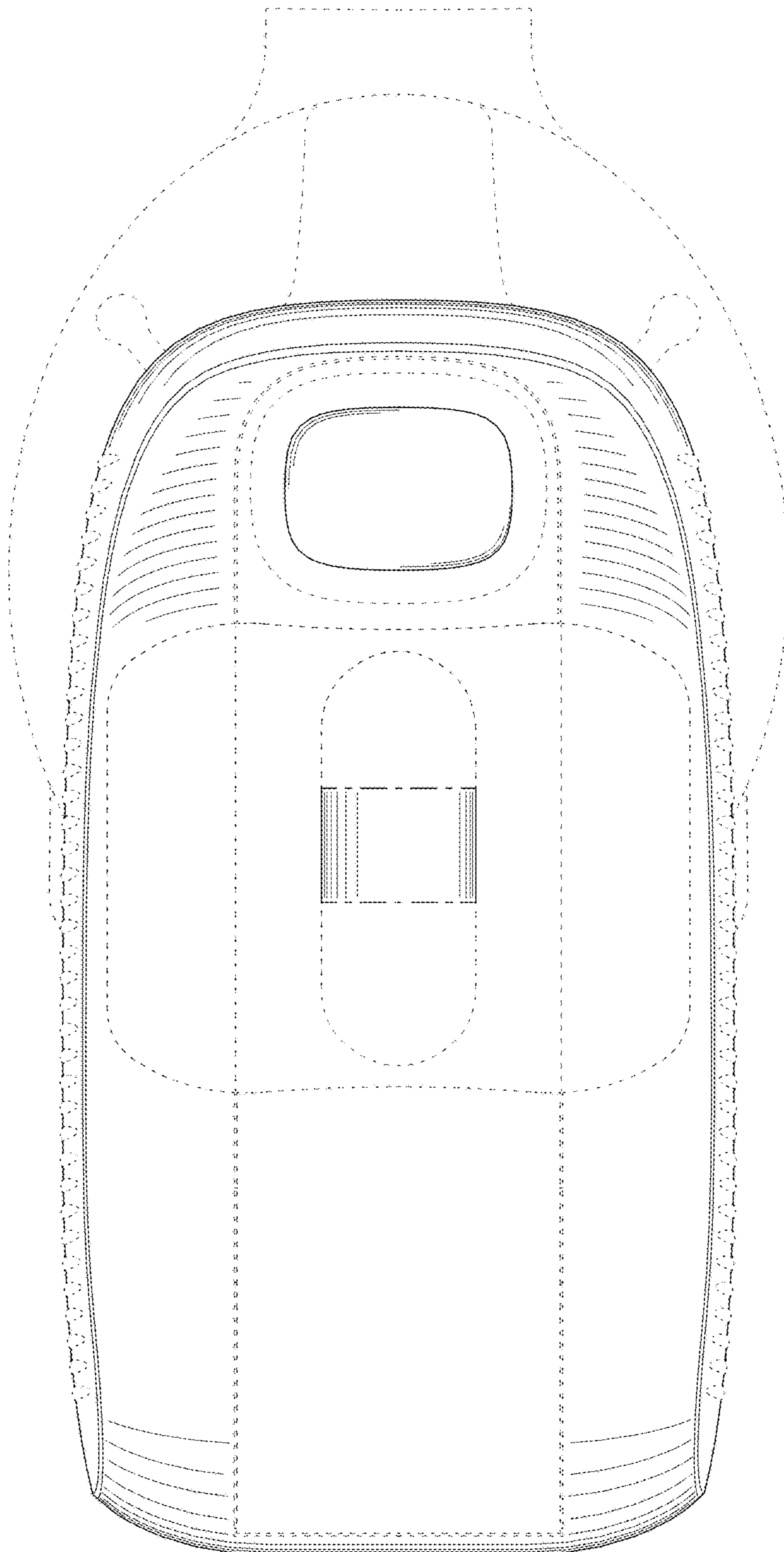

FIG. 6

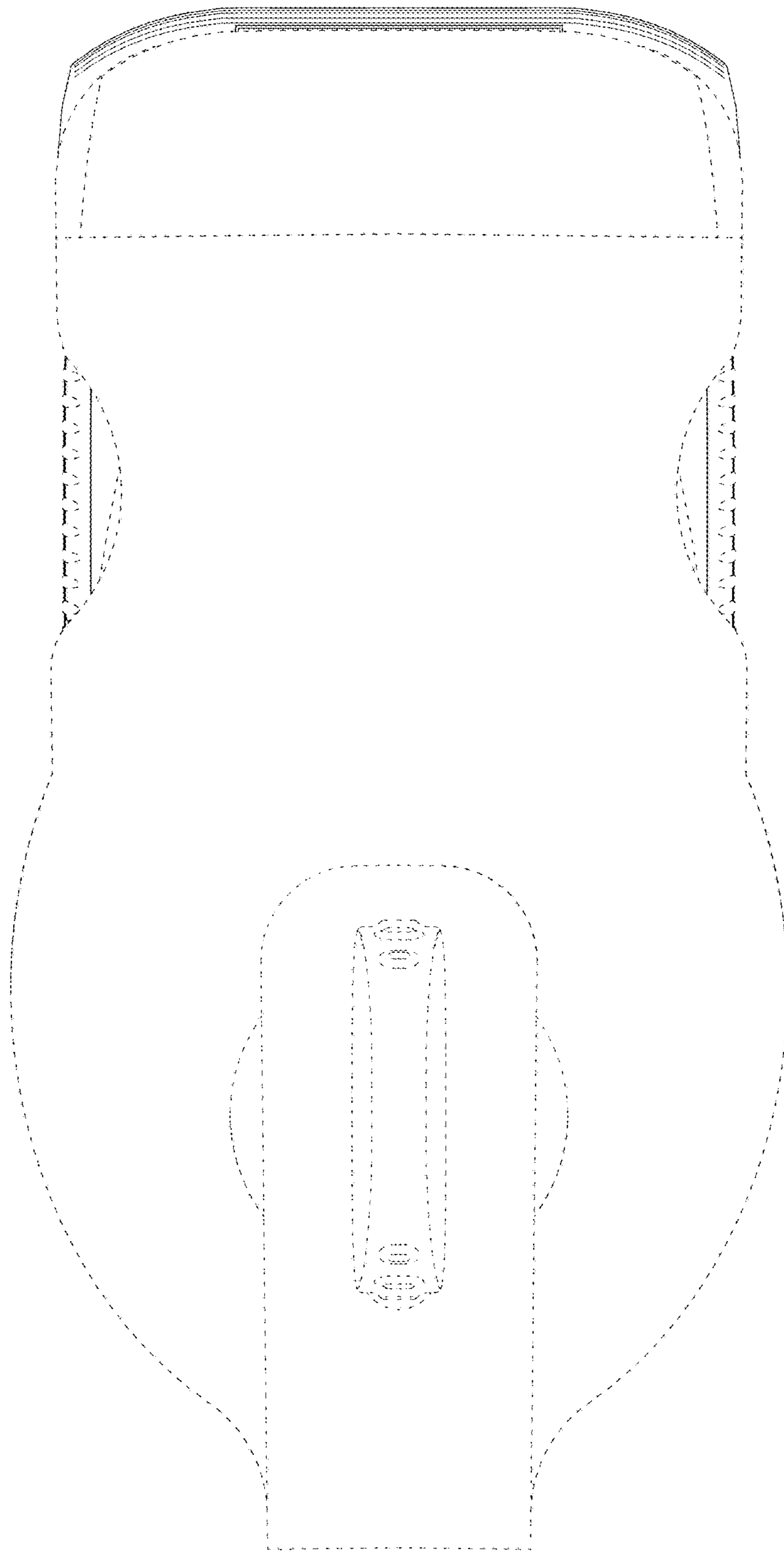

FIG. 7