



US00D806200S

(12) **United States Design Patent** (10) **Patent No.:** **US D806,200 S**
Findlay et al. (45) **Date of Patent:** **** Dec. 26, 2017**

(54) **RIFLE STOCK**

(71) Applicant: **Smith & Wesson Corp.**, Springfield, MA (US)

(72) Inventors: **David S. Findlay**, Athol, MA (US);
Frank Gillette, Liverpool, NY (US)

(73) Assignee: **Smith & Wesson Corp.**, Springfield, MA (US)

(**) Term: **15 Years**

(21) Appl. No.: **29/576,087**

(22) Filed: **Aug. 31, 2016**

Related U.S. Application Data

(62) Division of application No. 29/536,059, filed on Aug. 13, 2015, now Pat. No. Des. 781,391.

(51) **LOC (10) Cl.** **22-01**

(52) **U.S. Cl.**
USPC **D22/108**

(58) **Field of Classification Search**
USPC D21/572, 573, 576; D22/103, 108, 199;
D8/89, 107, 303
CPC F41C 23/04; F41C 23/06; F41C 23/14;
F41C 23/22; F41C 33/007
See application file for complete search history.

(56) **References Cited**

U.S. PATENT DOCUMENTS

D242,984 S *	1/1977	Petty	D8/303
D295,545 S	5/1988	Bell	
D297,855 S *	9/1988	Ruger	D22/103
D304,223 S *	10/1989	Ruger	D22/103
D324,473 S *	3/1992	Chen	D8/80
D381,887 S *	8/1997	Chen	D8/300
D399,282 S *	10/1998	Jarrett	D21/756
D424,399 S *	5/2000	Staton	D8/107
D476,392 S	6/2003	McGarry et al.	

(Continued)

Primary Examiner — Karen S Acker

Assistant Examiner — Steven B Reinholdt, Jr.

(74) *Attorney, Agent, or Firm* — John A. Chionchio, Esquire; Ballard Spahr LLP

(57) **CLAIM**

We claim the ornamental design for a rifle stock, as shown and described.

DESCRIPTION

FIG. 1 is left side view of an embodiment of our design for a rifle stock having gripping grooves;
 FIG. 2 is a magnified view thereof of area 2 circumscribed within FIG. 1;
 FIG. 3 is a right side view of the rifle stock shown in FIG. 1;
 FIG. 4 is a magnified view thereof of area 4 circumscribed within FIG. 3;
 FIG. 5 is a top view of the rifle stock shown in FIG. 1;
 FIG. 6 is a bottom view thereof;
 FIG. 7 is a back view thereof;
 FIG. 8 is a front view thereof;
 FIG. 9 is a left side view of a second embodiment of our design for a rifle stock having gripping grooves;
 FIG. 10 is a magnified view thereof of area 10 circumscribed within FIG. 9;
 FIG. 11 is a right side view of the rifle stock shown in FIG. 9;
 FIG. 12 is a magnified view thereof of area 12 circumscribed within FIG. 11;
 FIG. 13 is a top view of the rifle stock shown in FIG. 9;
 FIG. 14 is a bottom view thereof;
 FIG. 15 is a back view thereof; and,
 FIG. 16 is a front view thereof.

The broken lines illustrate portions of the rifle stock that form no part of the claimed design. The dot-dash-dot broken lines depict the boundaries of the magnified views and form no part of the claimed design.

1 Claim, 14 Drawing Sheets

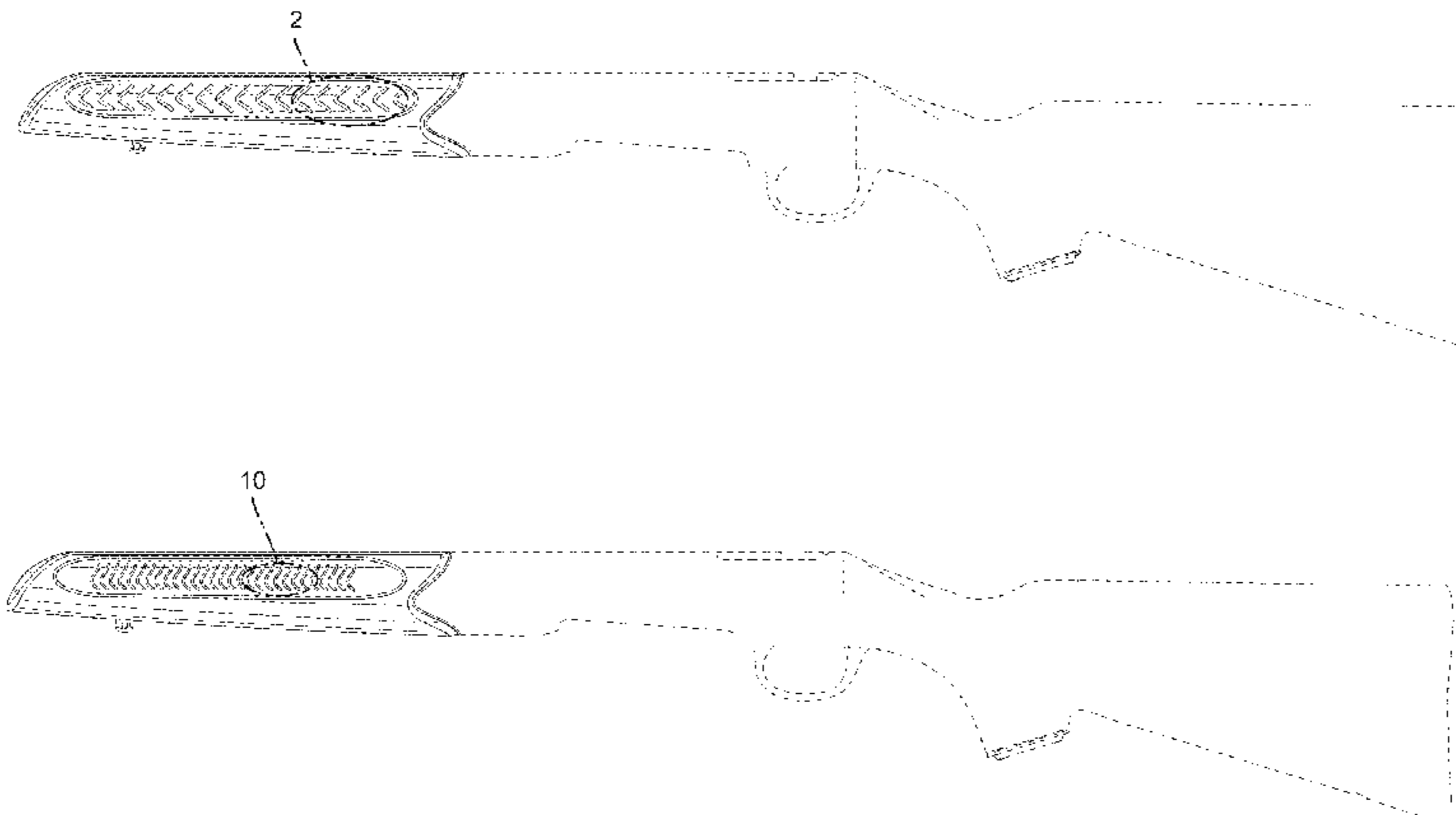

(56)

References Cited

U.S. PATENT DOCUMENTS

D518,351	S	*	4/2006	Hay	D8/1
D581,766	S	*	12/2008	Heneen	D8/107
D605,006	S	*	12/2009	Shiao	D8/107
D618,980	S	*	7/2010	Wang	D8/107
D618,981	S	*	7/2010	Gringer	D32/41
D651,274	S	*	12/2011	Moretti	D22/103
D654,341	S	*	2/2012	Hantke	D8/89
8,151,504	B1	*	4/2012	Aiston	F41C 23/10 42/71.01
D661,569	S	*	6/2012	Chen	D8/107
D679,356	S	*	4/2013	Klotz	D22/103
D692,514	S	*	10/2013	Vera	D22/108
D697,161	S	*	1/2014	Kera	D22/108
D712,498	S		9/2014	DuPlooy		
D723,644	S	*	3/2015	Alis	D22/103
D725,737	S	*	3/2015	Gambill	D22/108
D748,217	S		1/2016	Kera		
D779,619	S	*	2/2017	Findlay	D22/103
D781,391	S	*	3/2017	Findlay	D22/108

* cited by examiner

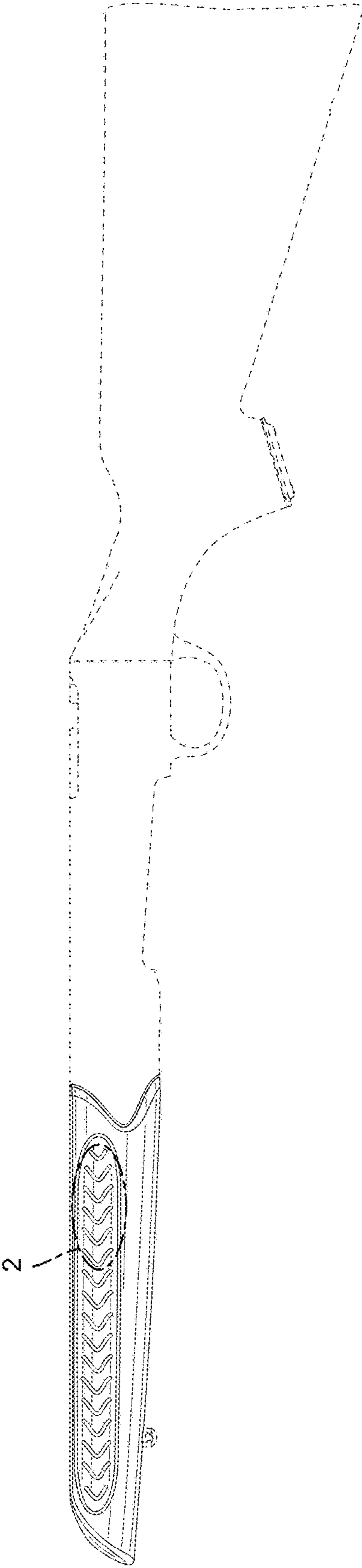

FIG. 1

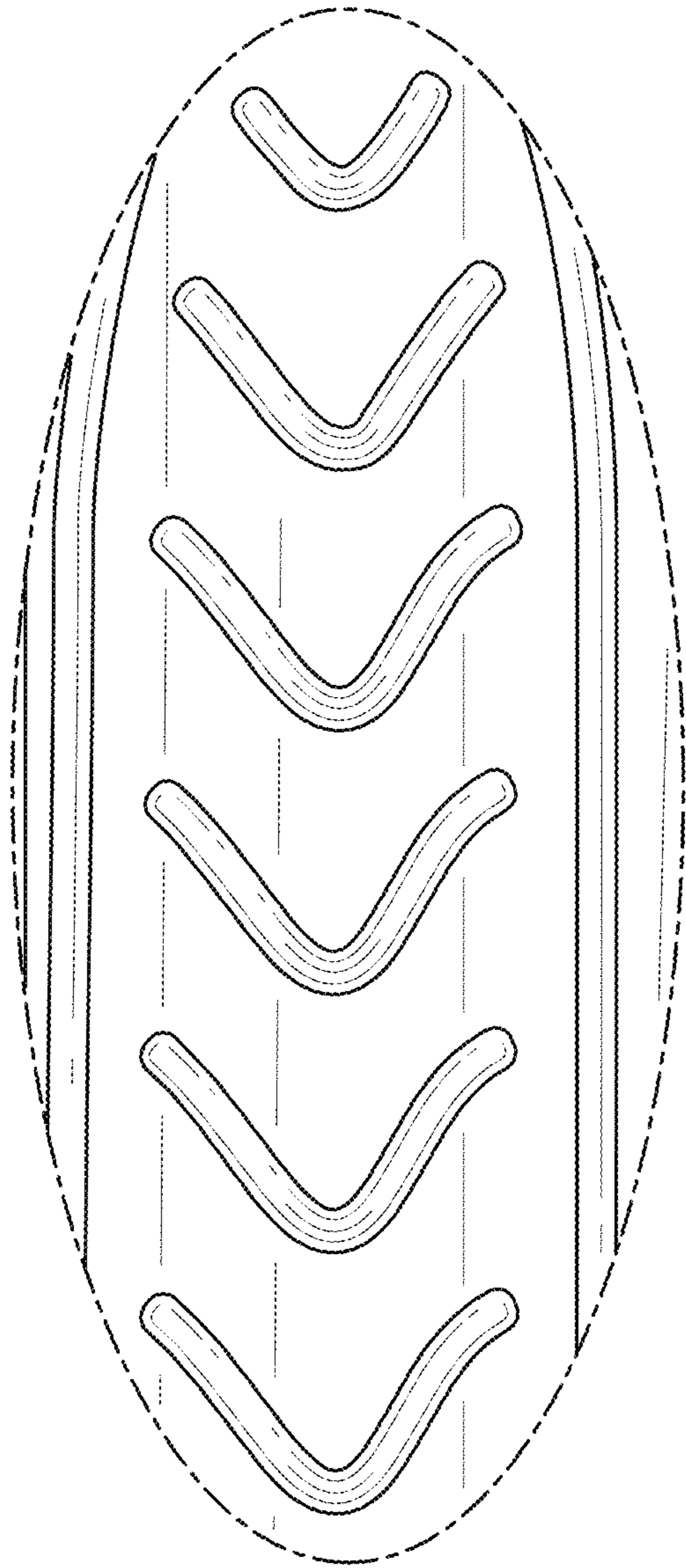

FIG. 2

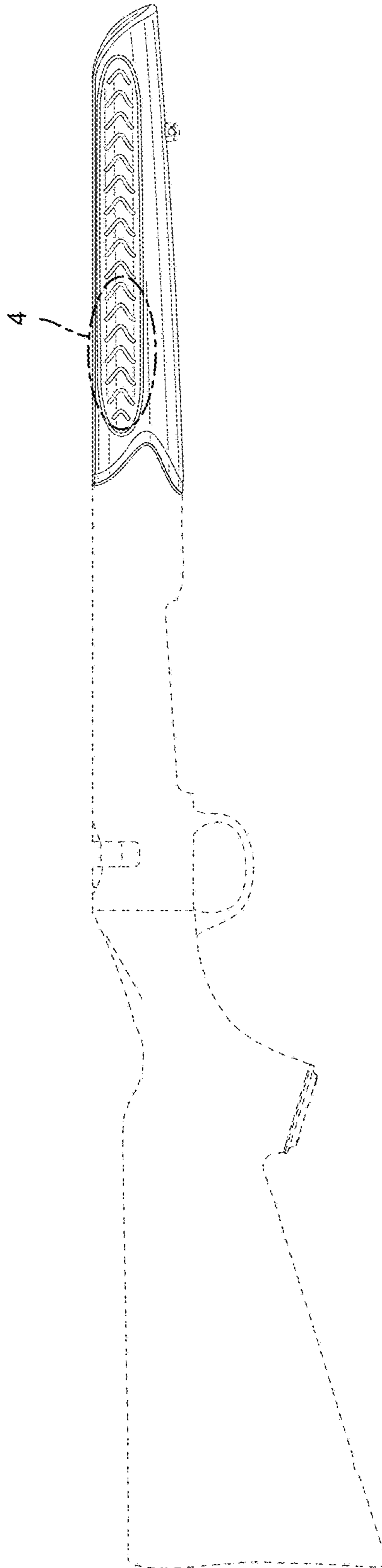

FIG. 3

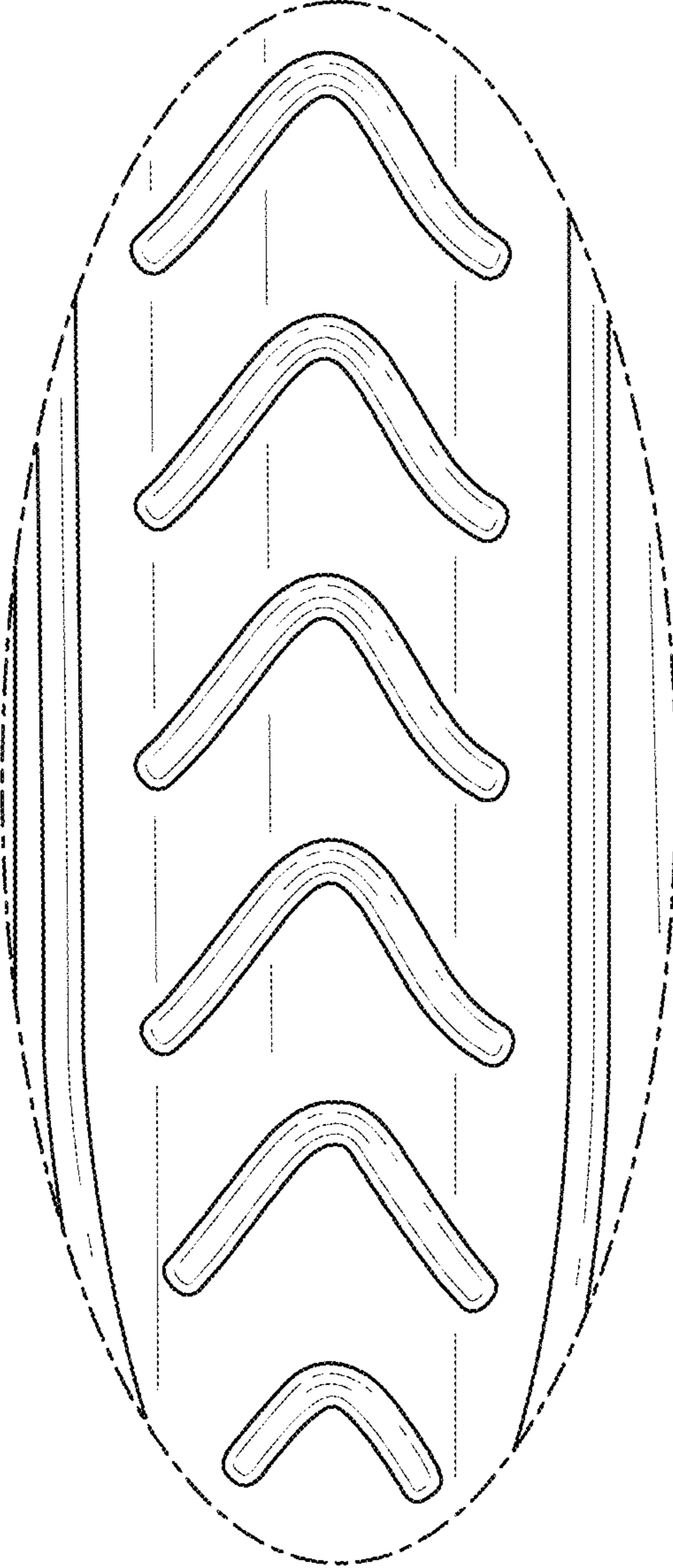

FIG. 4

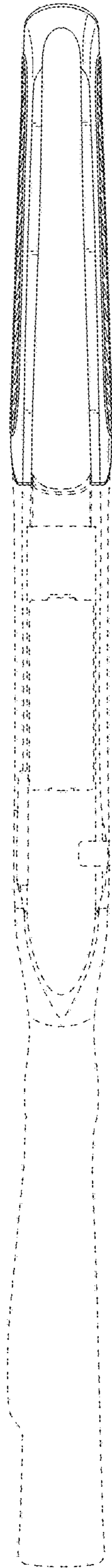

FIG. 5

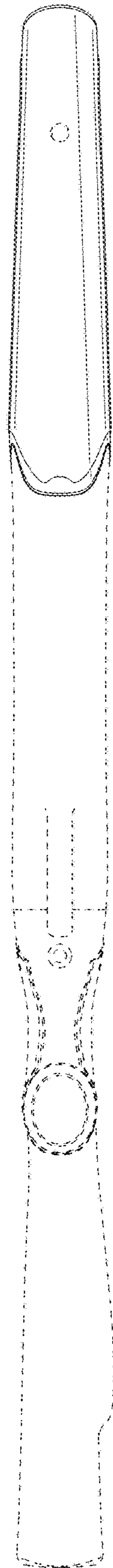

FIG. 6

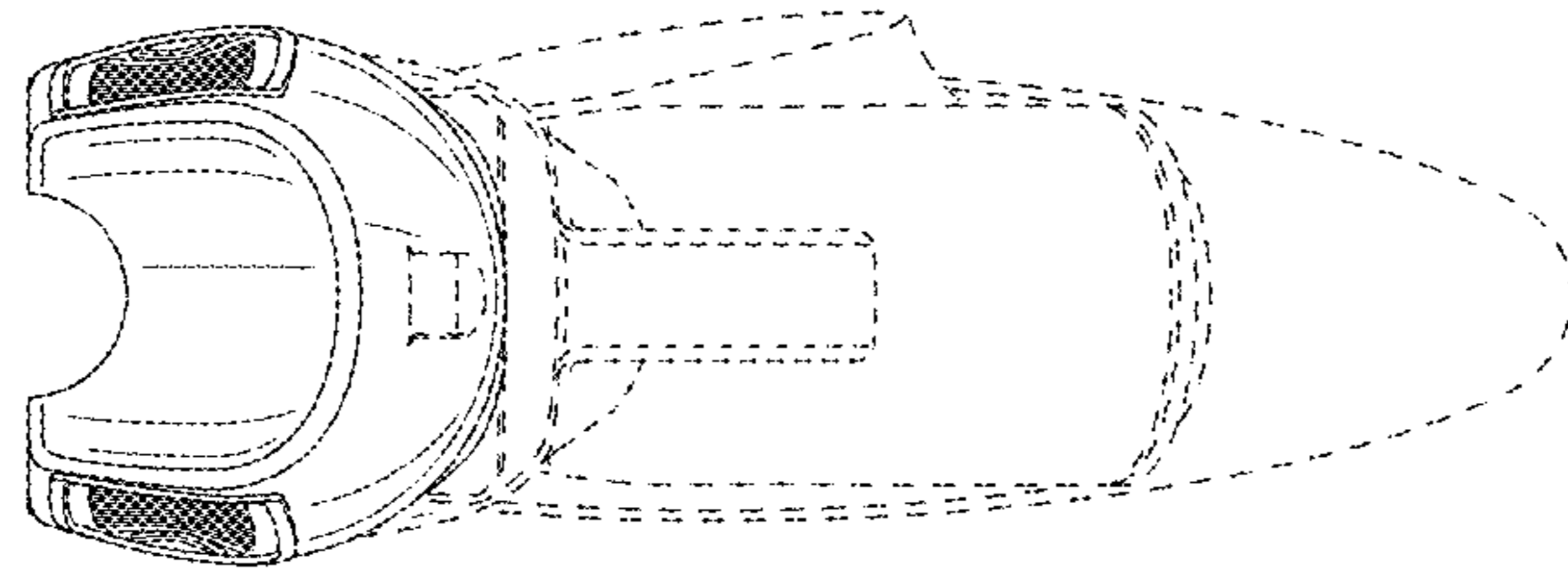

FIG. 8

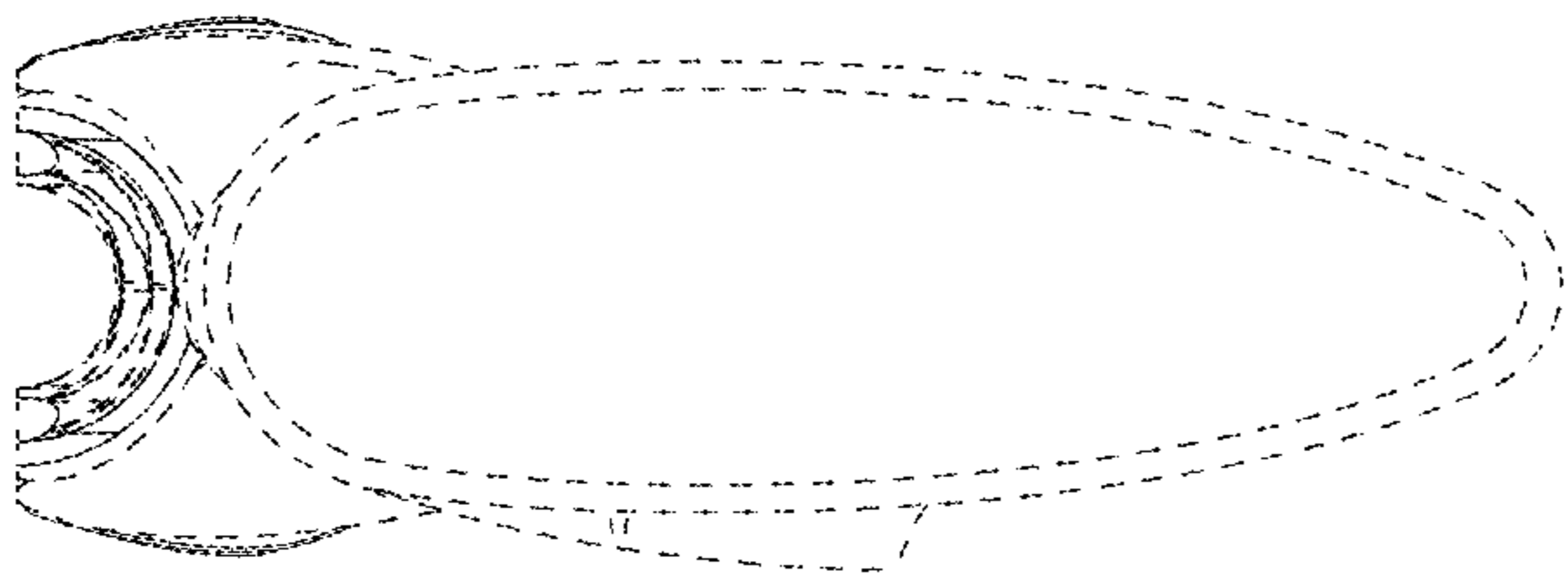

FIG. 7

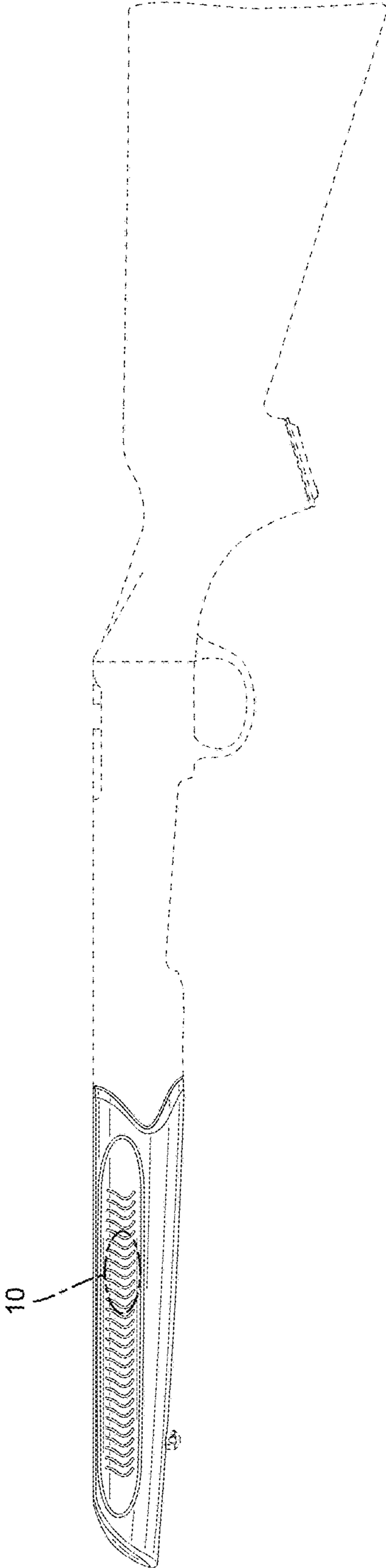

FIG. 9

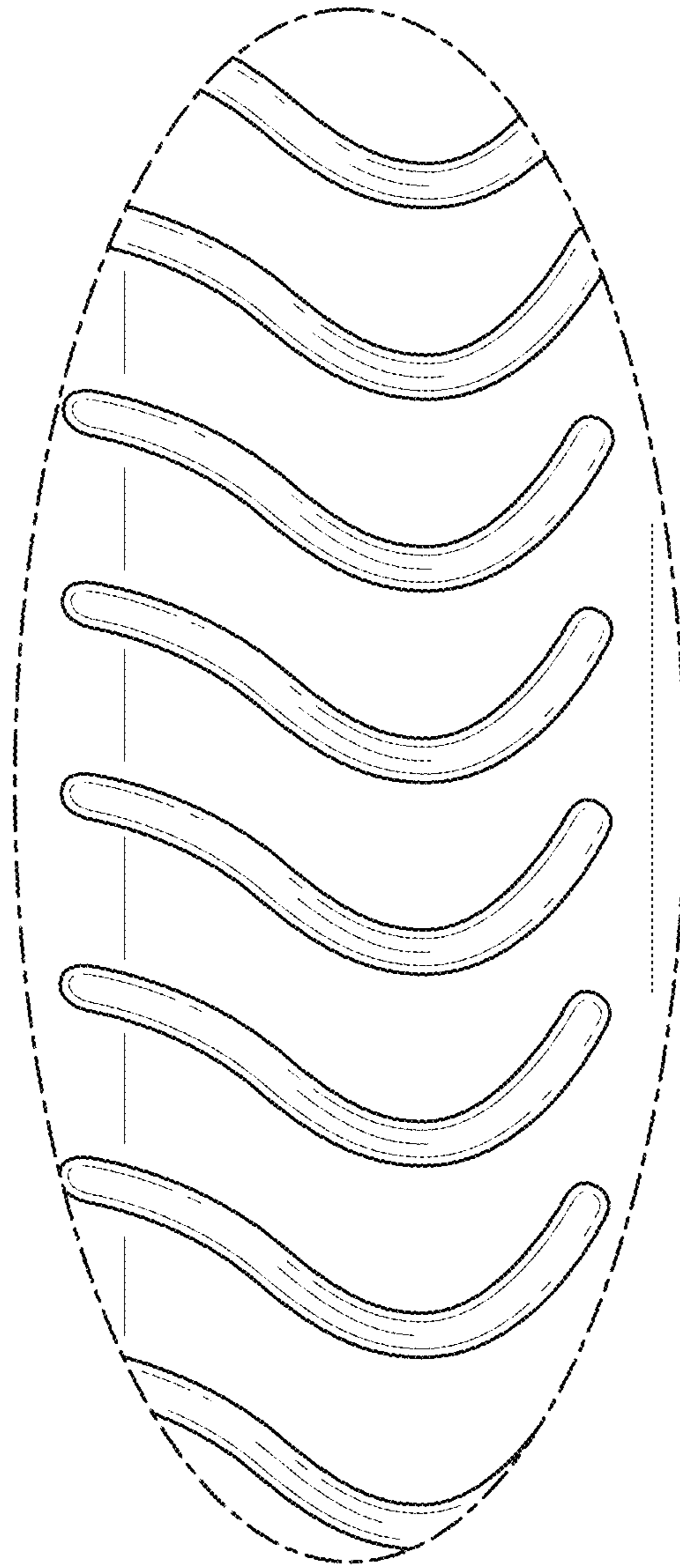

FIG. 10

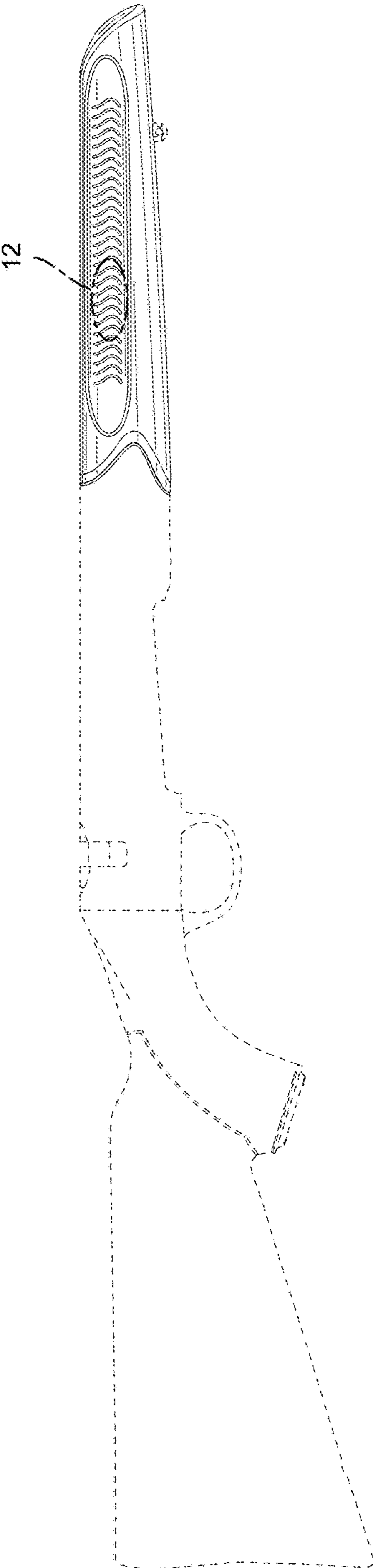

FIG. 11

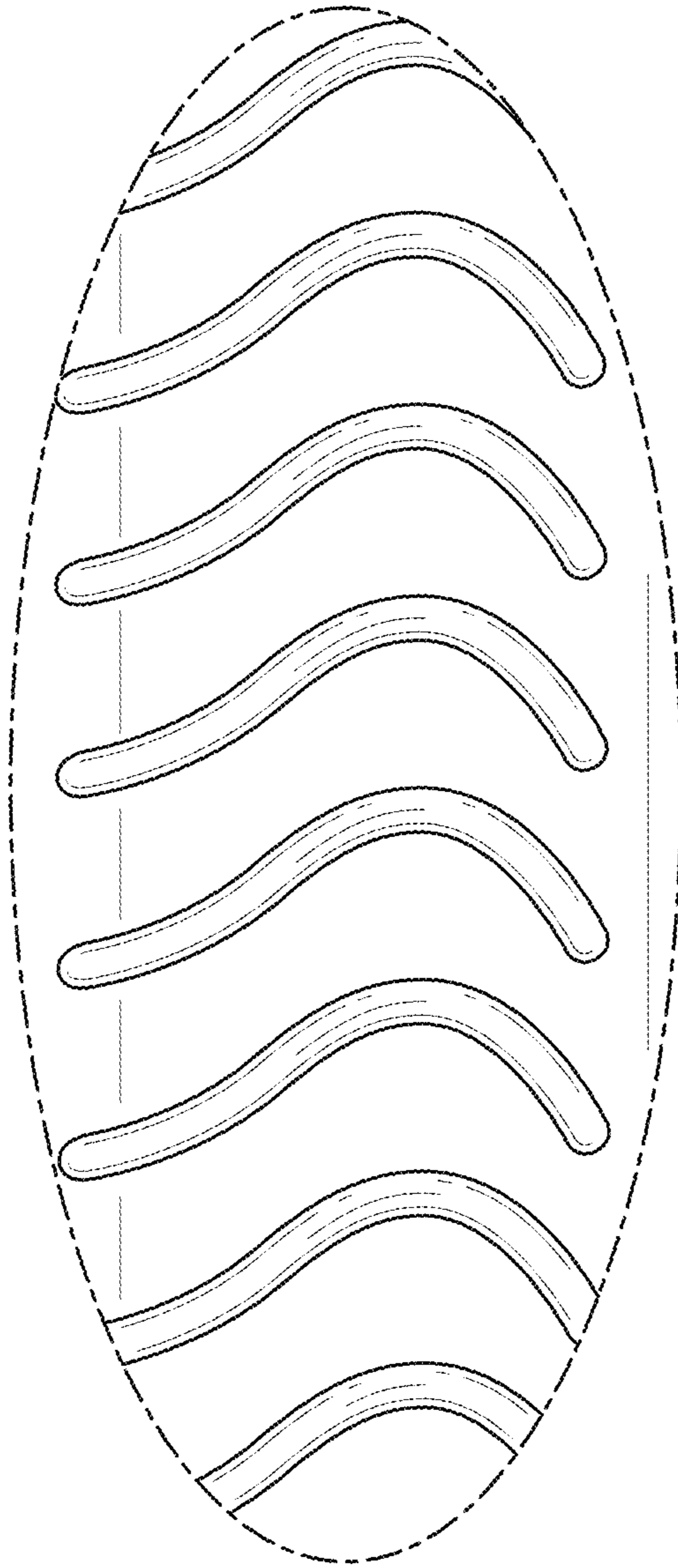

FIG. 12

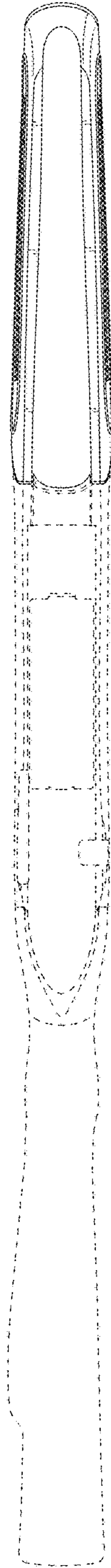

FIG. 13

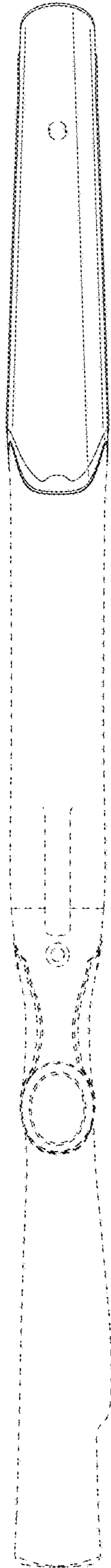

FIG. 14

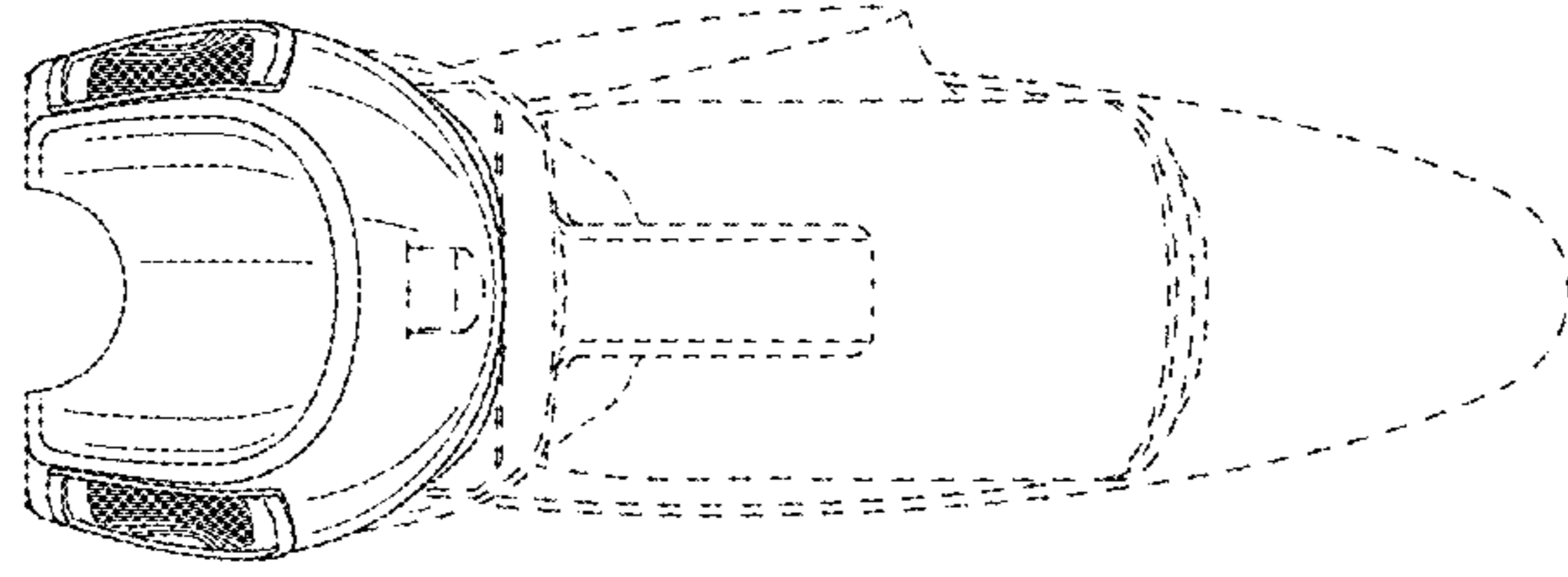

FIG. 16

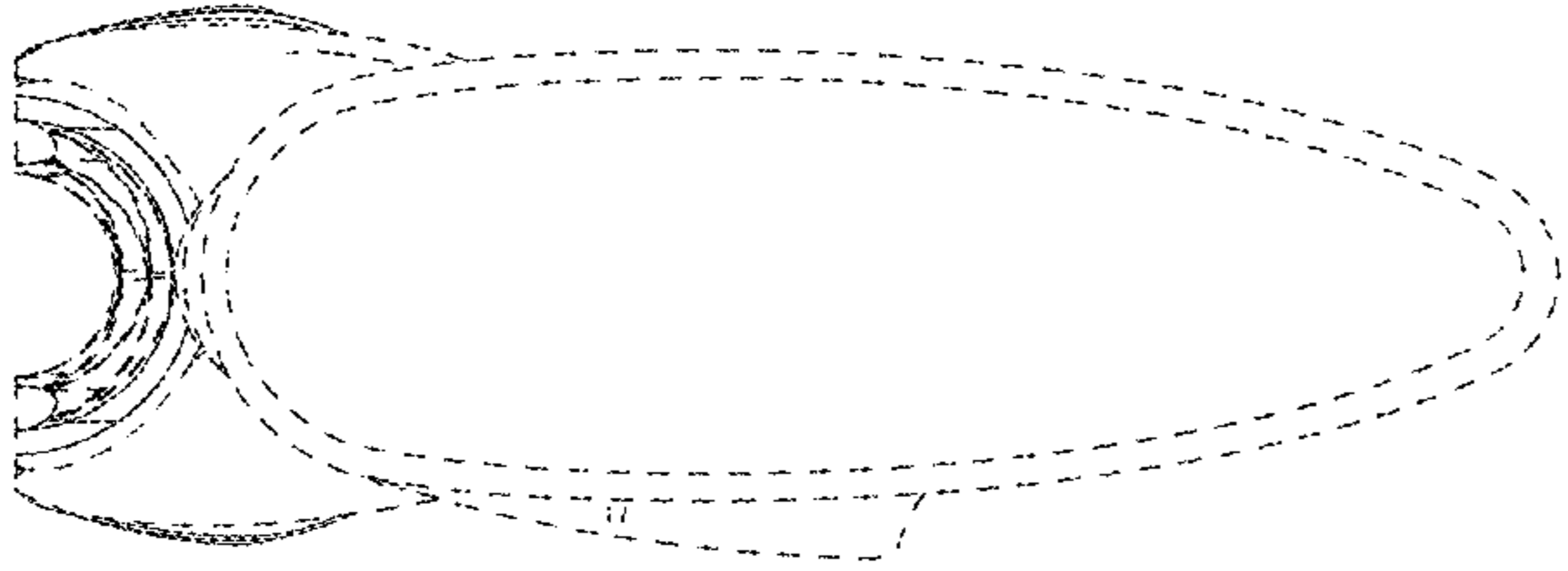

FIG. 15