



US00D805915S

(12) **United States Design Patent**
Albertini

(10) **Patent No.:** **US D805,915 S**

(45) **Date of Patent:** **** Dec. 26, 2017**

(54) **PACKAGING FOR BEAUTY PRODUCTS**

- (71) Applicant: **Christian Louboutin**, Paris (FR)
- (72) Inventor: **Carole Albertini**, Levallois-Perret (FR)
- (73) Assignee: **Christian Louboutin**, Paris (FR)
- (**) Term: **14 Years**

- (21) Appl. No.: **29/510,766**
- (22) Filed: **Dec. 3, 2014**

(30) **Foreign Application Priority Data**

Jun. 3, 2014 (EM) 002475509-0001

(51) **LOC (10) Cl.** **09-01**

(52) **U.S. Cl.**
USPC **D9/657**; D9/521; D9/558

(58) **Field of Classification Search**
USPC D9/439, 449, 452, 454, 516, 521, 529,
D9/530, 539, 544, 552, 554, 558, 715,
D9/719; D28/76, 81, 82, 90
CPC B65D 1/0223; B65D 85/34; B65D 35/44;
B65D 3/06
See application file for complete search history.

(56) **References Cited**

U.S. PATENT DOCUMENTS

D63,610 S	*	12/1923	Breeden	D9/521
D101,901 S	*	11/1936	Vuilleminot	D9/529
D286,747 S	*	11/1986	Kostanecki	D9/447
D286,984 S	*	12/1986	Durand	D9/552
D309,566 S	*	7/1990	Mileos	D9/695
D312,392 S	*	11/1990	Mileos	D9/697
D319,010 S	*	8/1991	Kotyuk	D9/521
D324,174 S	*	2/1992	Litton	D9/435
D353,773 S	*	12/1994	Desgrippes	D9/451
D372,869 S	*	8/1996	Mahlmann	D9/504
D387,989 S	*	12/1997	Chahed	D9/516

(Continued)

OTHER PUBLICATIONS

Louboutin, C., Compte rendu de recherches de Dessins & Modèles, RCD140004—Trois tubes de rouge à lèvres. Mar. 4, 2014.

Primary Examiner — Ian Simmons

Assistant Examiner — Keith Frank

(74) *Attorney, Agent, or Firm* — Fross Zelnick Lehrman & Zissu, P.C.; Charles T. J. Weigell, Esq.

(57) **CLAIM**

The ornamental design for packaging for beauty products, as shown and described.

DESCRIPTION

FIG. 1 is a front perspective view of the cap portion of the packaging for beauty products shown removed from the body portion;

FIG. 2 is a front elevation view thereof, the rear being the same;

FIG. 3 is a right side elevation view thereof, the left side elevation being the same;

FIG. 4 is a top plan view thereof;

FIG. 5 is a bottom plan view thereof;

FIG. 6 is a front perspective view of the packaging for beauty products showing my new design;

FIG. 7 is a front elevation view thereof, with the rear elevation being the same;

FIG. 8 is a right side elevation view thereof, with the left side elevation being the same;

FIG. 9 is a top plan view thereof;

FIG. 10 is a bottom plan view thereof;

FIG. 11 is a front perspective view of the body portion of FIG. 6, shown with the cap portion removed;

FIG. 12 is a front elevation view thereof, the rear, right side and left side views being the same;

FIG. 13 is a top plan view thereof; and,

FIG. 14 is a bottom plan view thereof.

The broken lines in the drawings illustrate the portions that form no part of the claimed design.

1 Claim, 11 Drawing Sheets

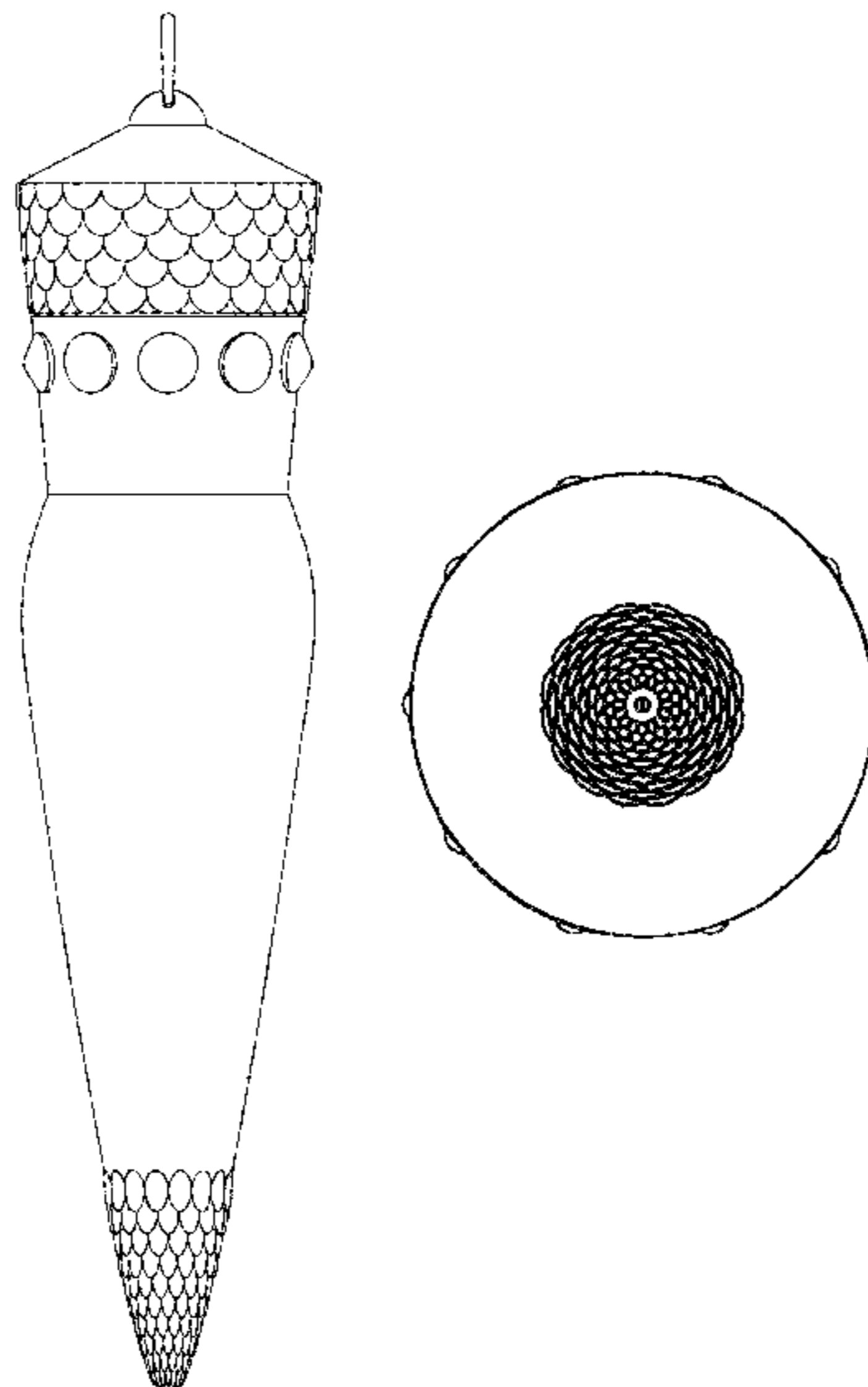

(56)

References Cited

U.S. PATENT DOCUMENTS

D395,239	S	*	6/1998	Davis	D9/521
D404,647	S	*	1/1999	Federighi	D9/439
D418,062	S	*	12/1999	de Baschmakoff	D9/520
D485,167	S	*	1/2004	Chan	D1/116
D522,375	S	*	6/2006	Archeny	D9/521
D666,459	S	*	9/2012	Kolano	D7/628
D708,063	S	*	7/2014	Jones	D9/503
D736,624	S	*	8/2015	Berlepsch	D9/451
D746,681	S	*	1/2016	Jasso Gomez	D9/451
D749,420	S	*	2/2016	Kahlau	D9/420
D754,541	S	*	4/2016	Jasso Gomez	D9/451

* cited by examiner

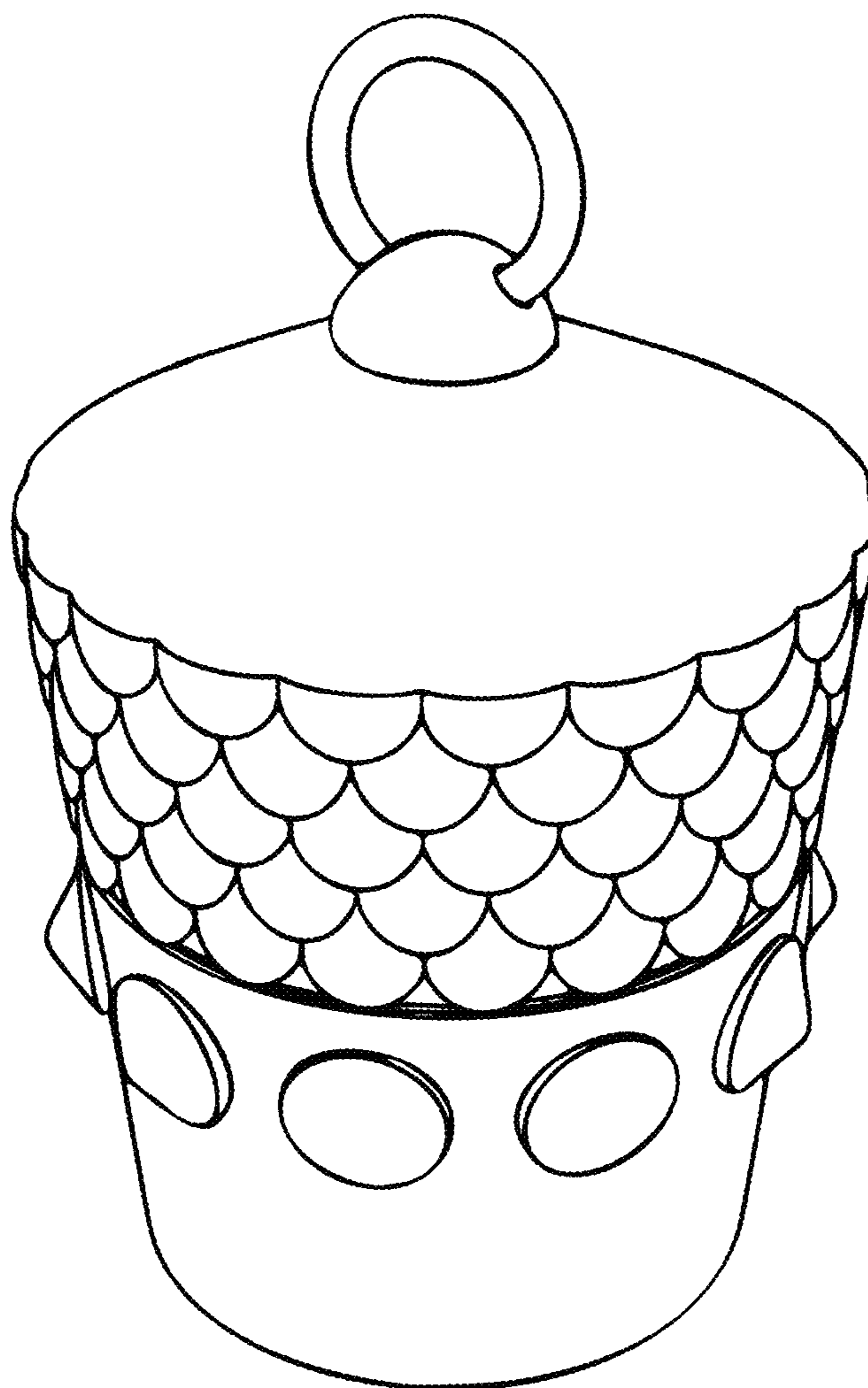

FIG. 1

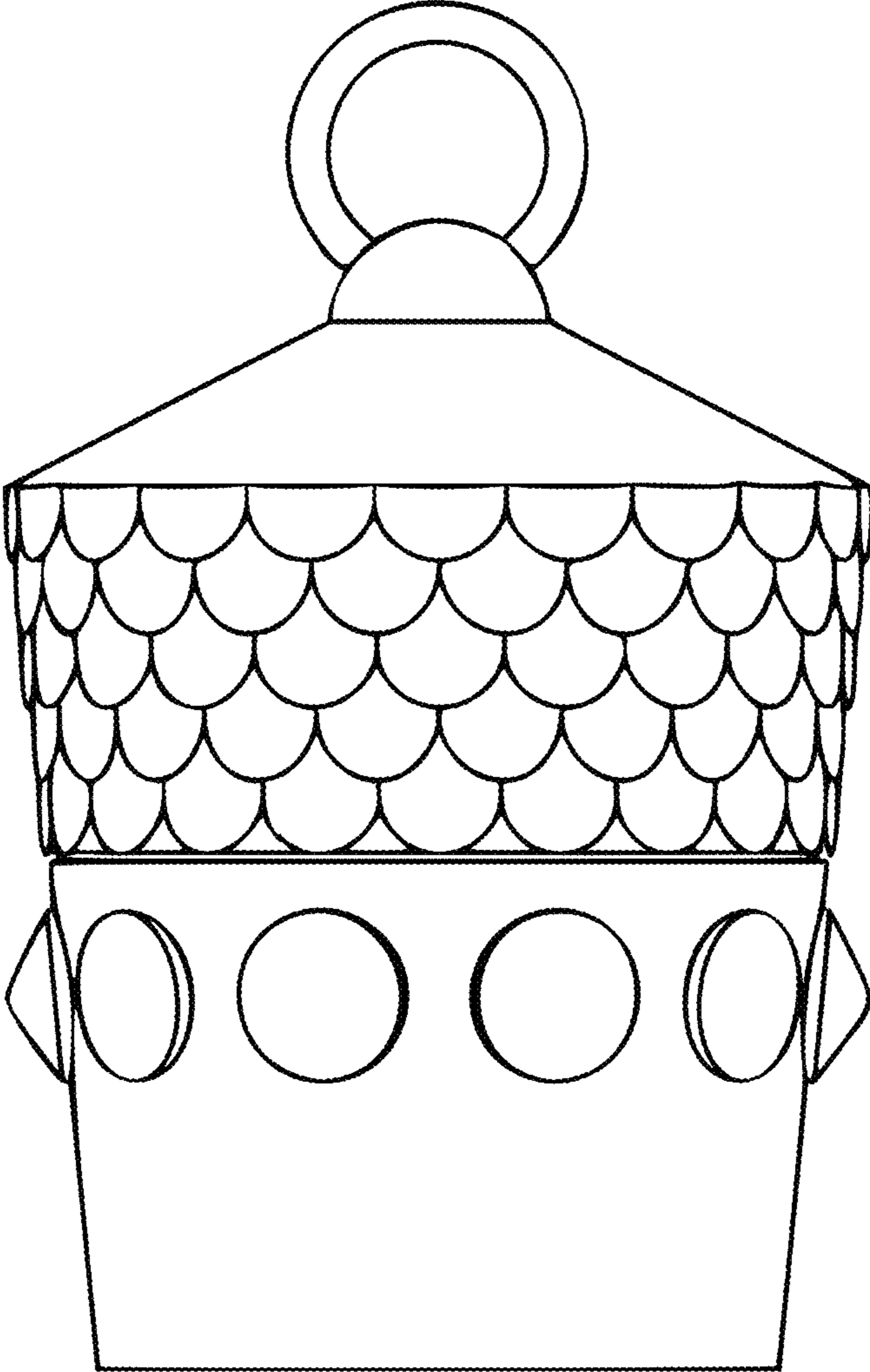

FIG. 2

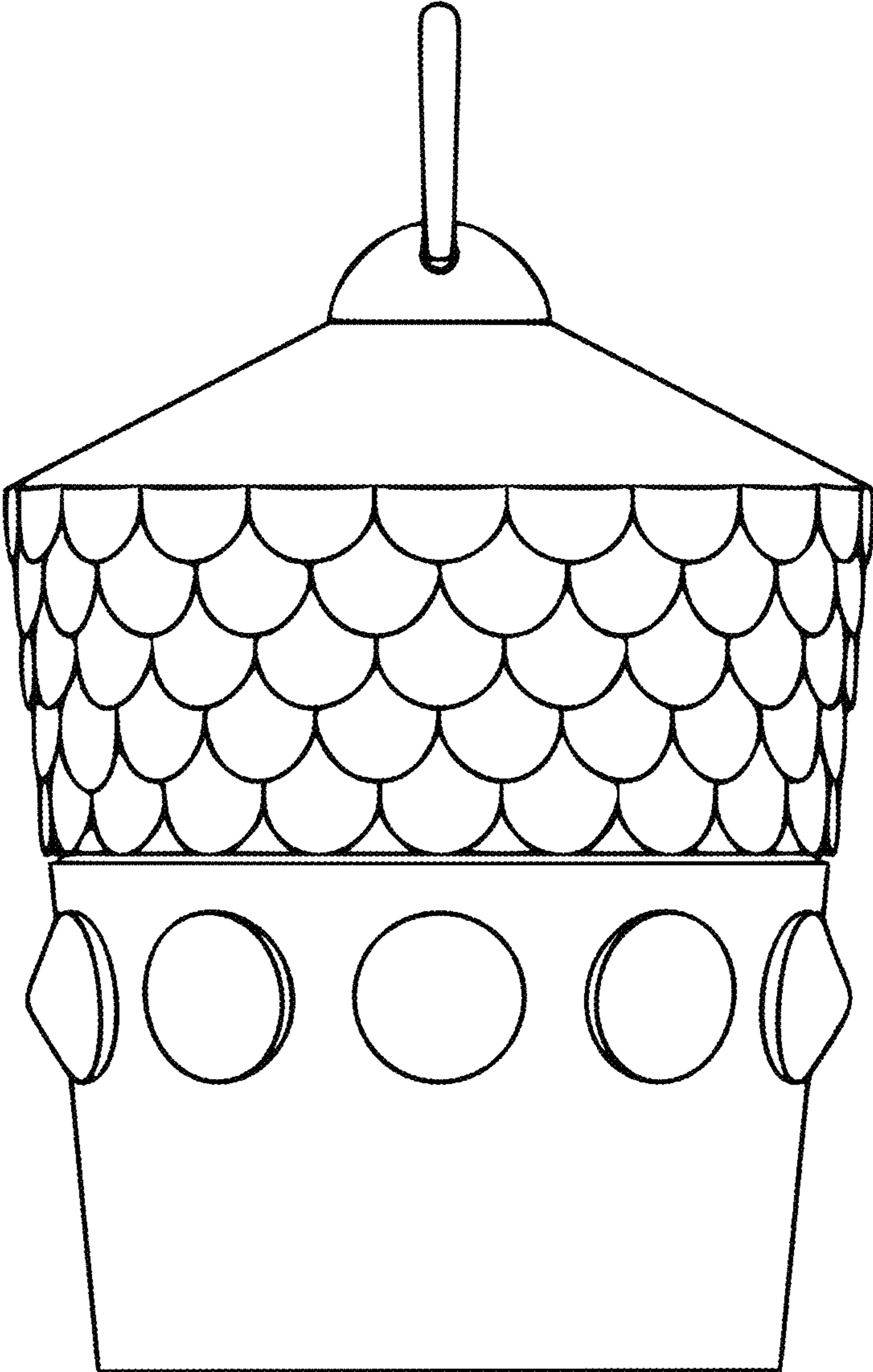

FIG. 3

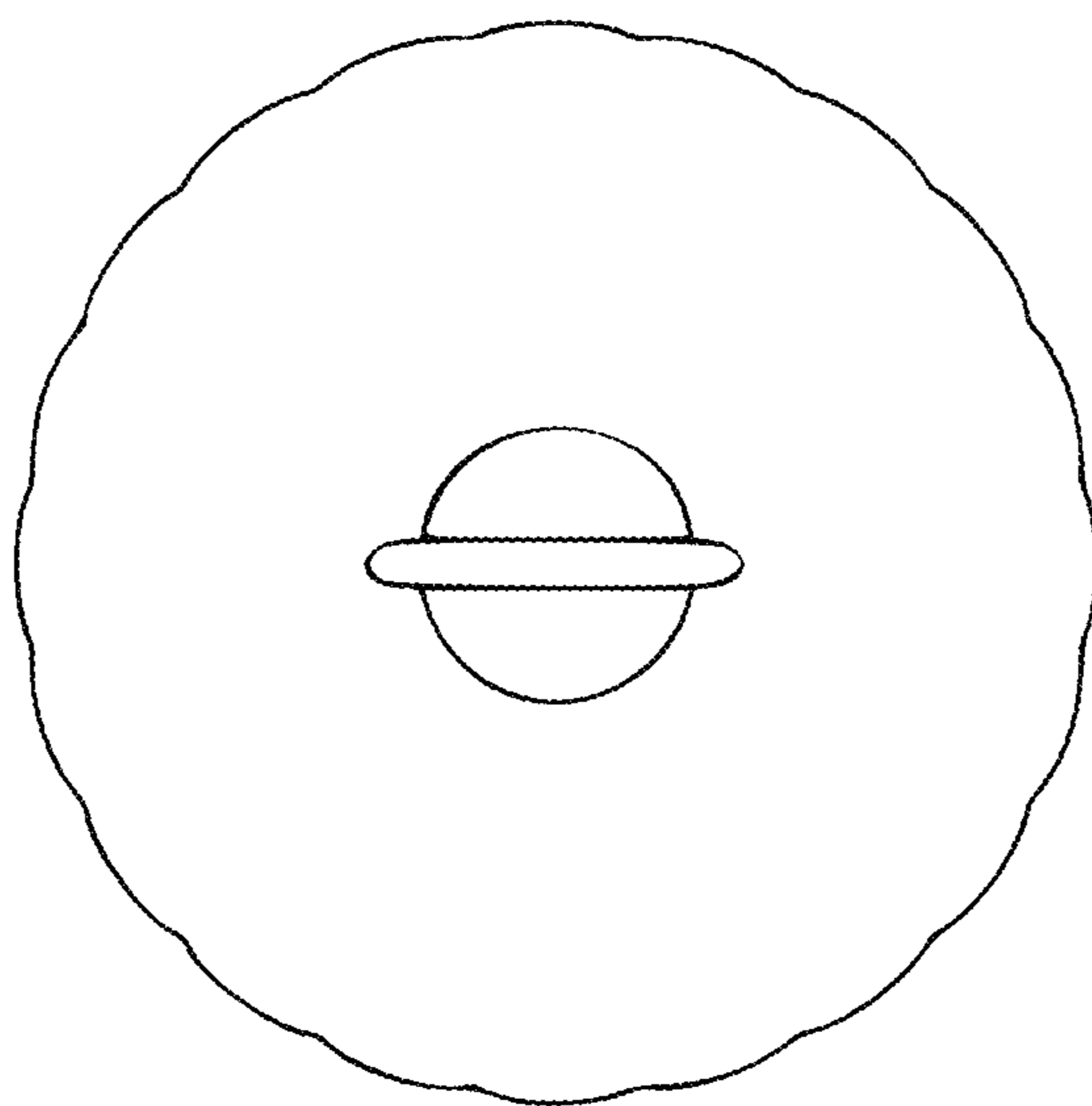

FIG. 4

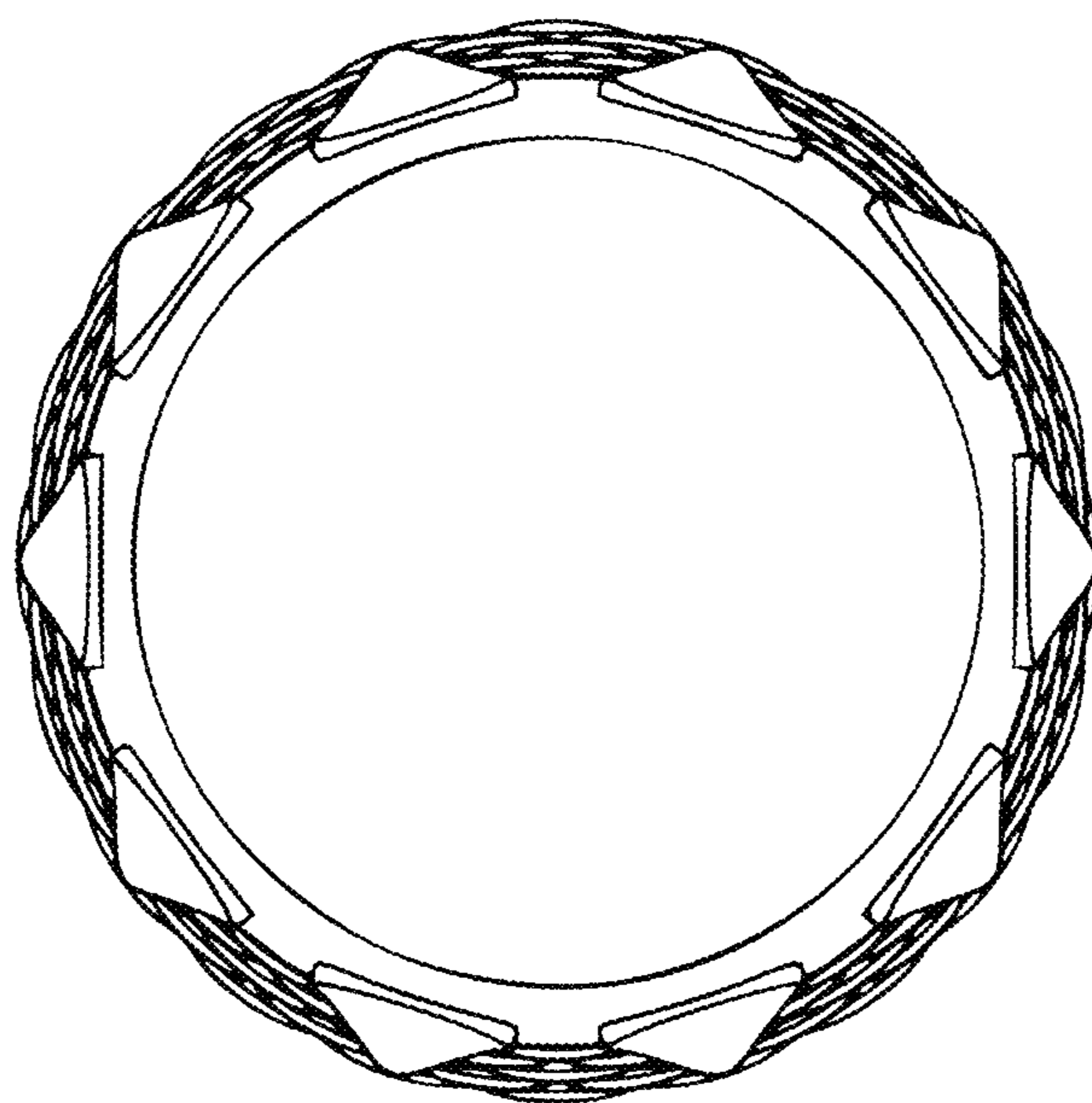

FIG. 5

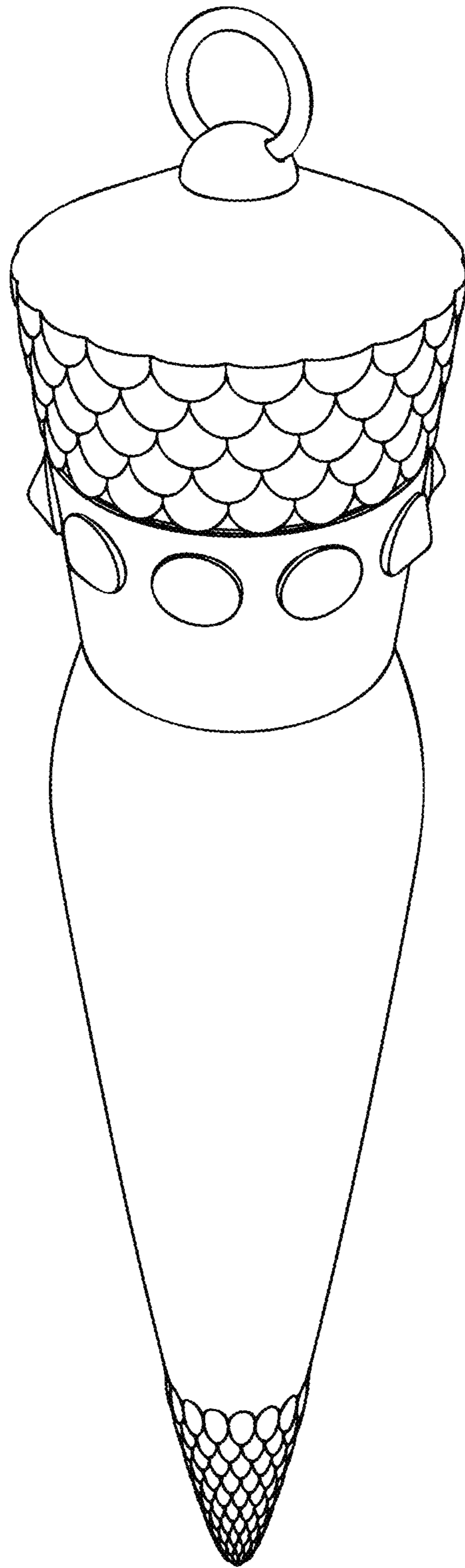

FIG. 6

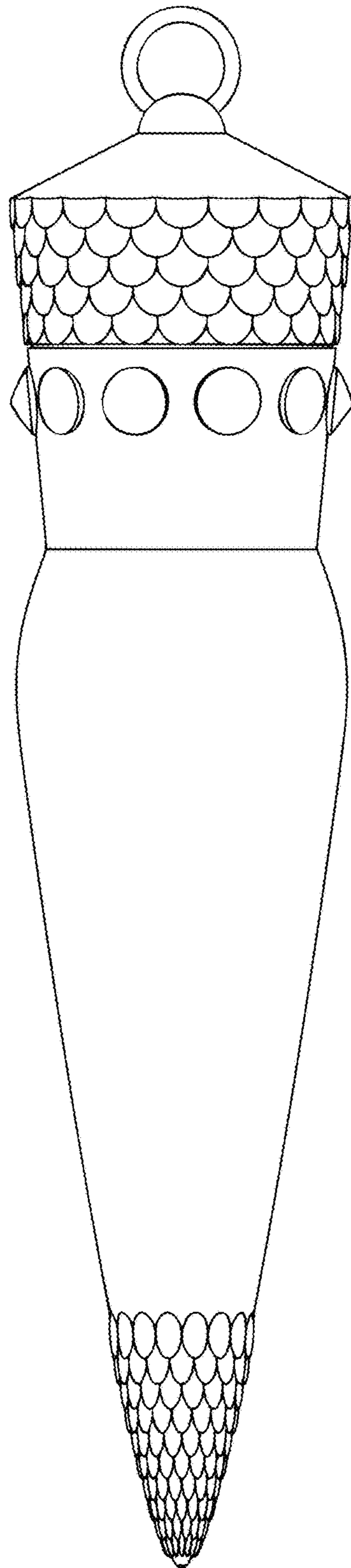

FIG. 7

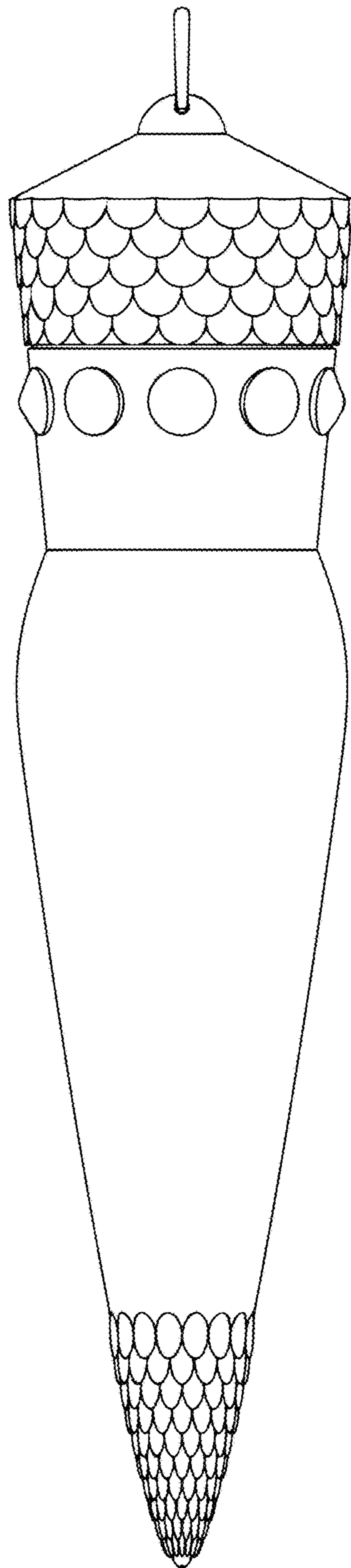

FIG. 8

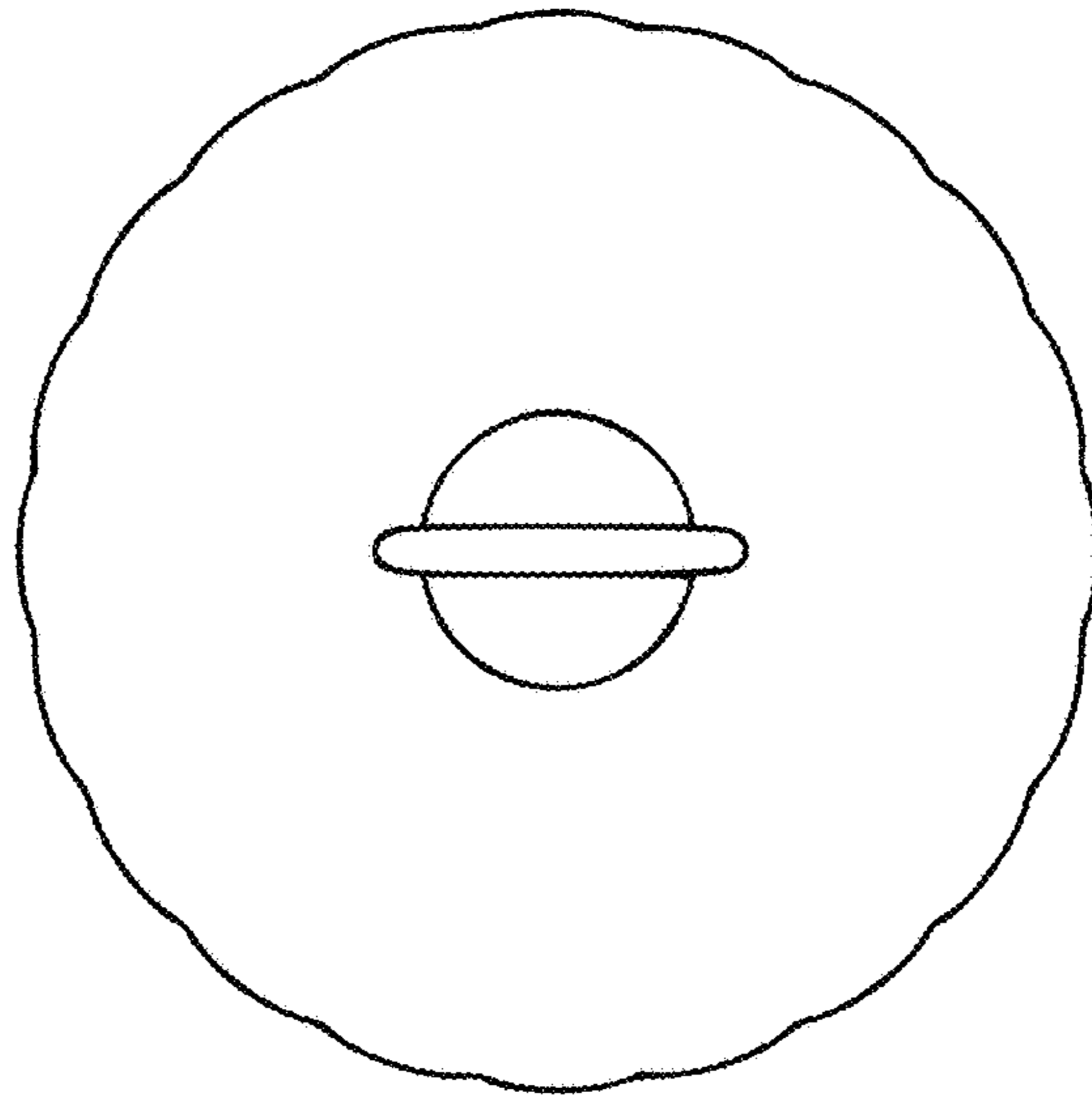

FIG. 9

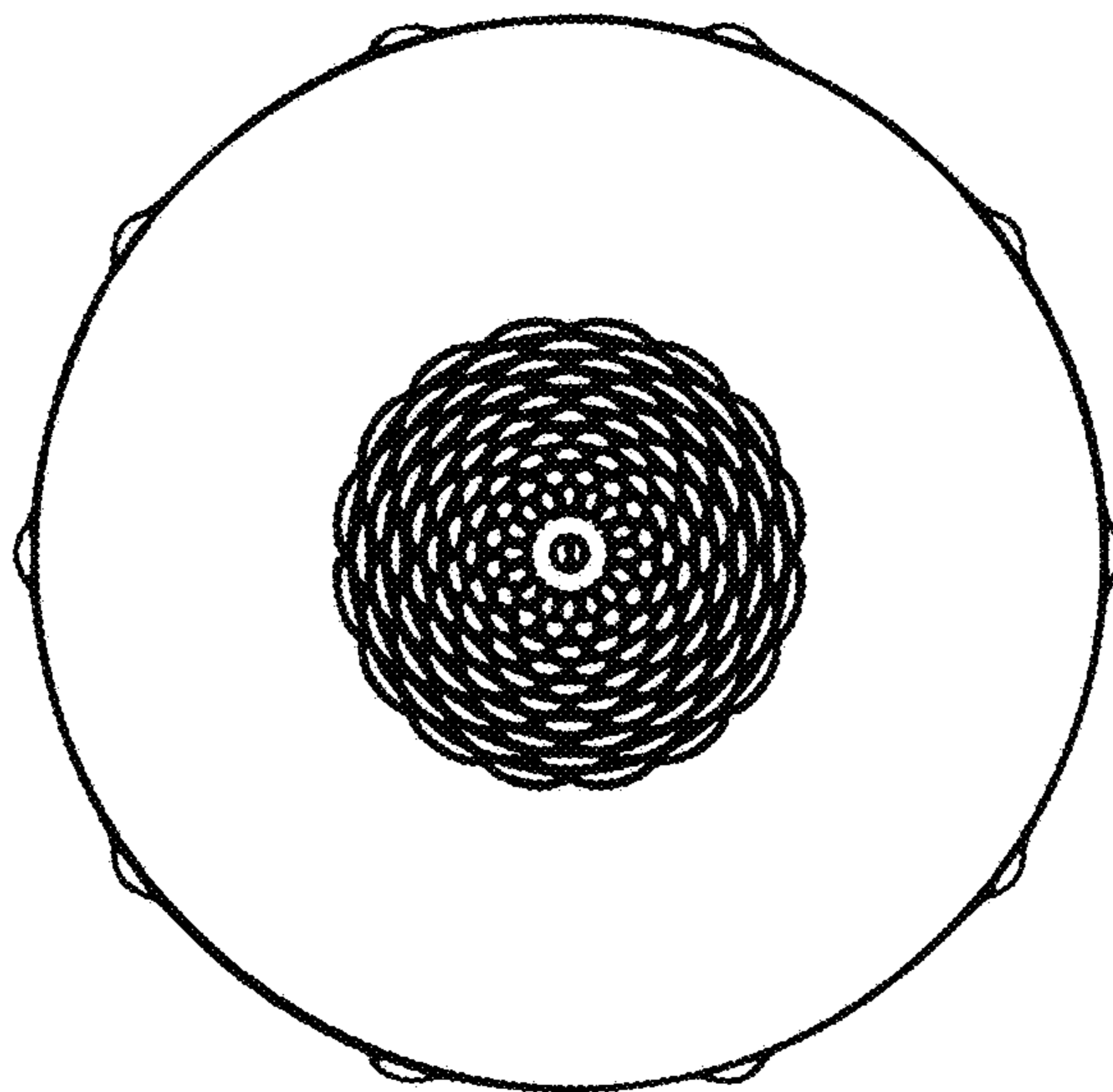

FIG. 10

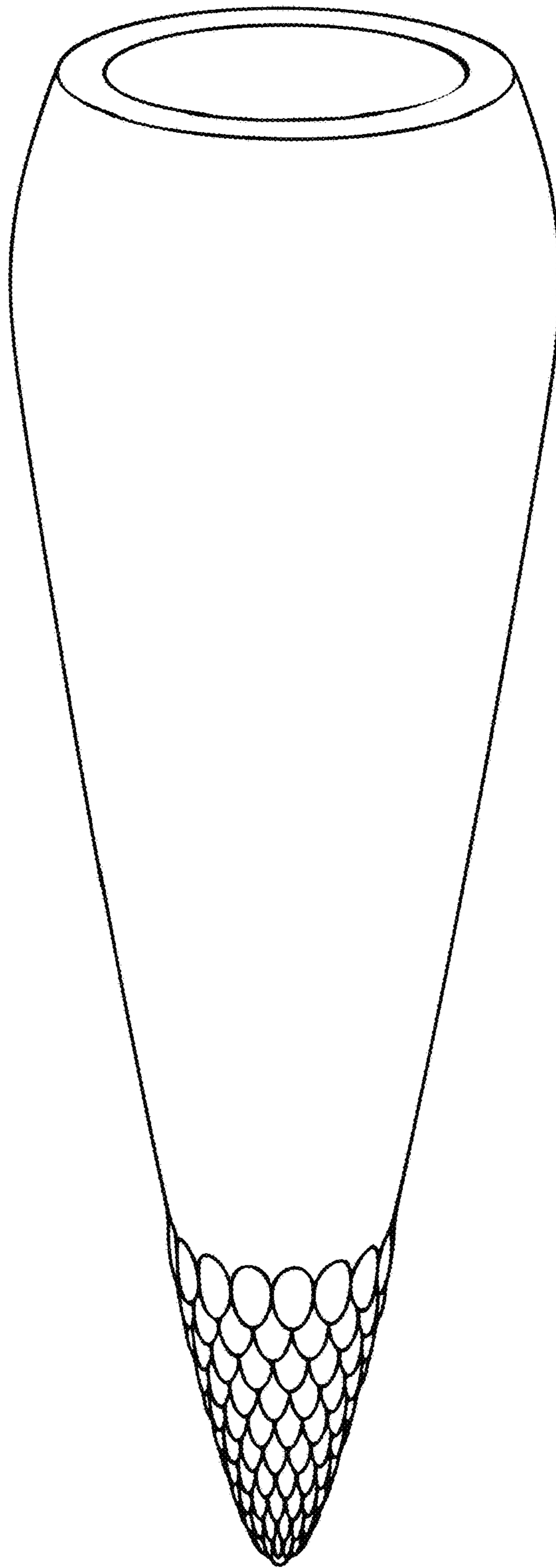

FIG. 11

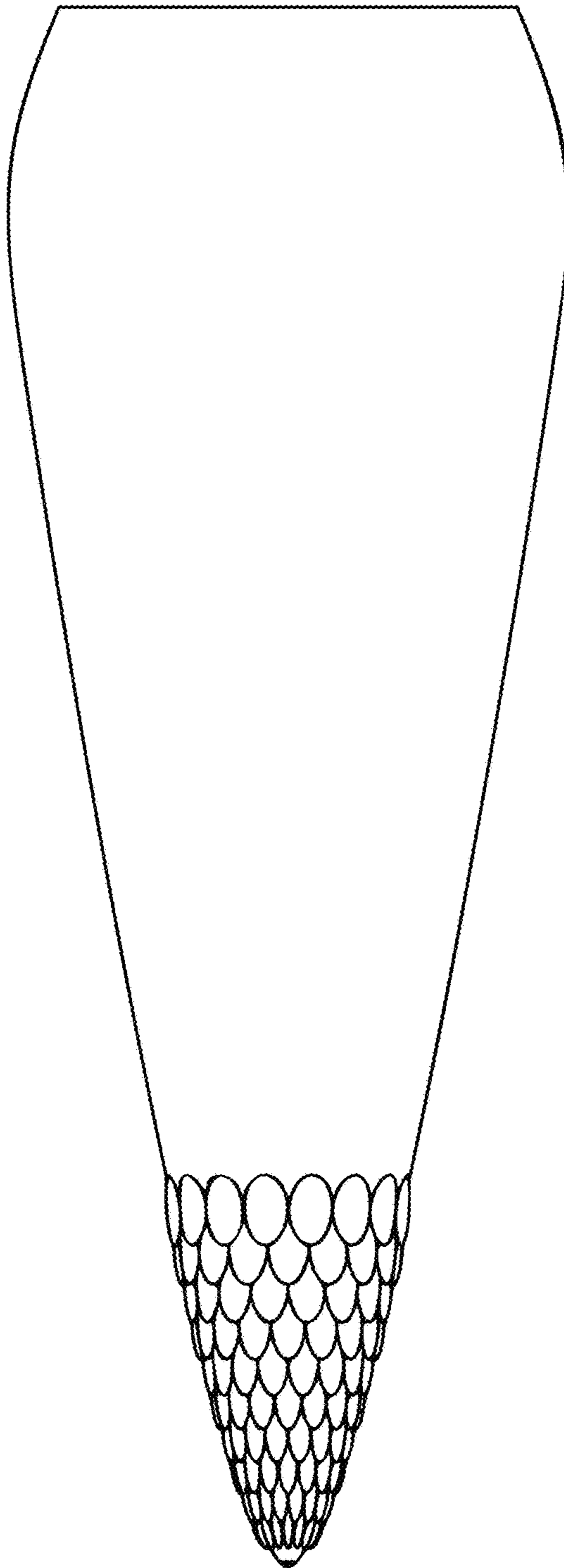

FIG. 12

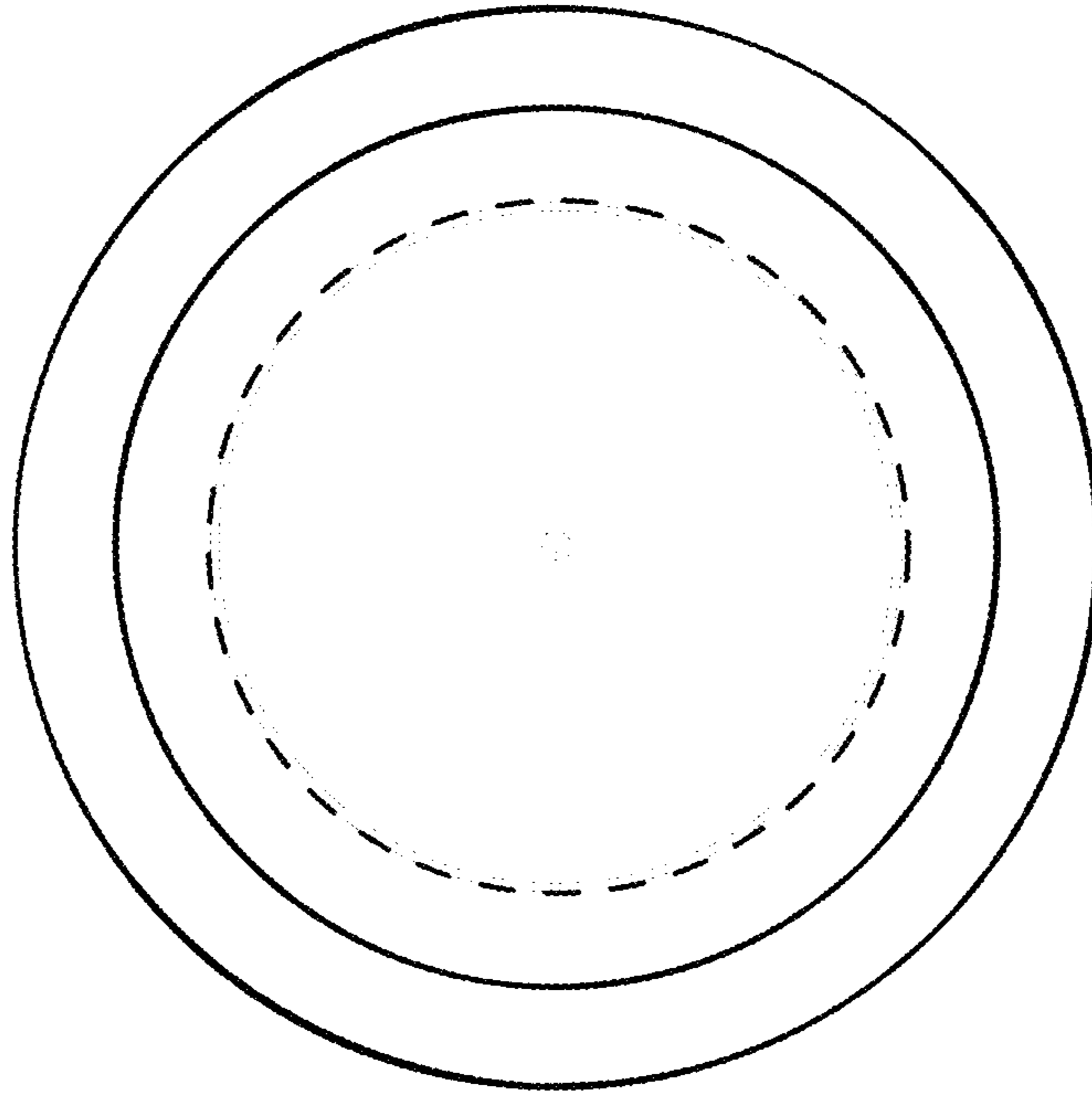

FIG. 13

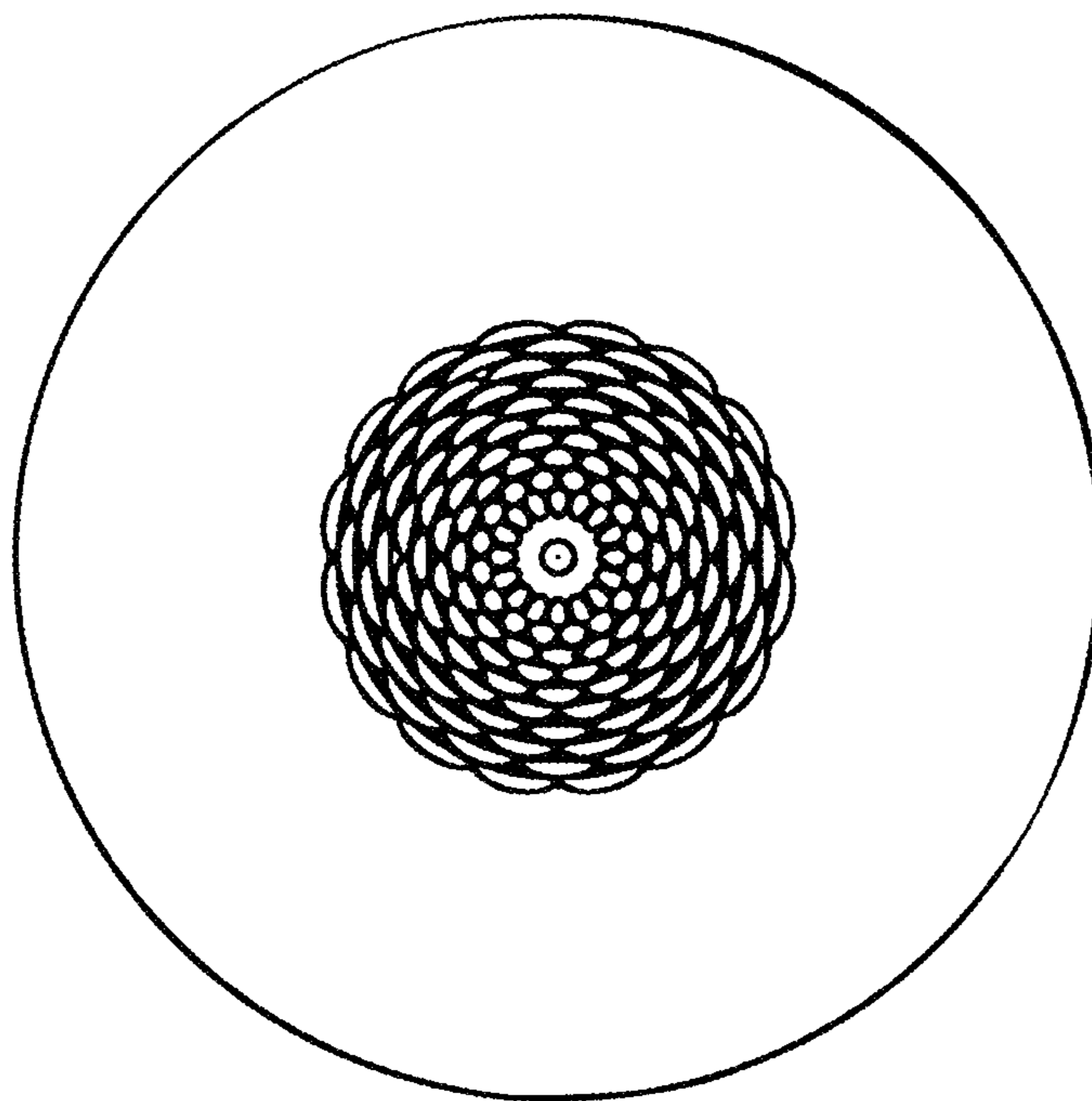

FIG. 14

UNITED STATES PATENT AND TRADEMARK OFFICE
CERTIFICATE OF CORRECTION

PATENT NO. : D805,915 S
APPLICATION NO. : 29/510766
DATED : December 26, 2017
INVENTOR(S) : Carole Albertini

Page 1 of 1

It is certified that error appears in the above-identified patent and that said Letters Patent is hereby corrected as shown below:

On the Title Page

(30) Foreign Application Priority Data should read:

(30) Foreign Application Priority Data

June 3, 2014 (EM)002475509

Signed and Sealed this
Twenty-eighth Day of May, 2019

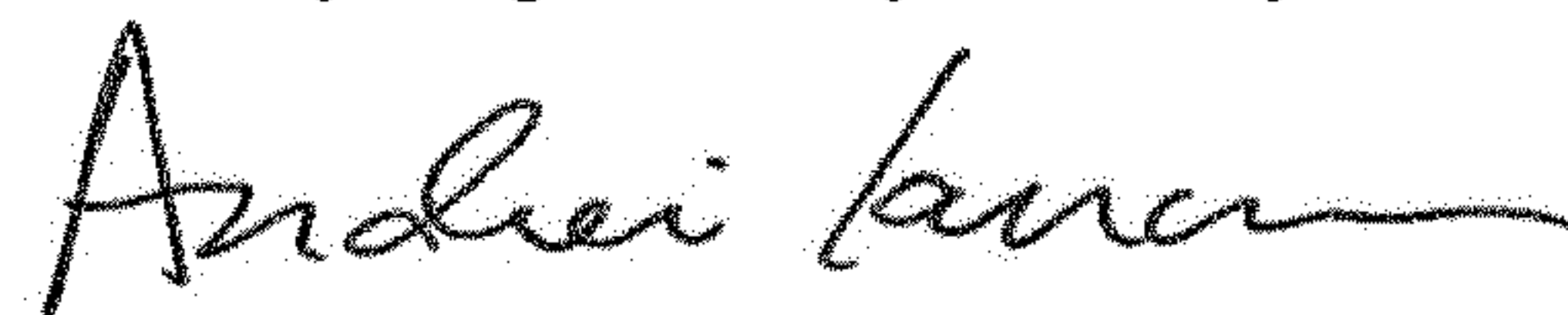

Andrei Iancu
Director of the United States Patent and Trademark Office