



US00D805815S

(12) **United States Design Patent** (10) **Patent No.:** **US D805,815 S**
Leonorovitz (45) **Date of Patent:** **** Dec. 26, 2017**

(54) **JEWELRY BOX**

(71) Applicant: **GLENOR INC**, Brooklyn, NY (US)

(72) Inventor: **Goldy Leonorovitz**, Brooklyn, NY (US)

(73) Assignee: **Glenor Inc.**, Brooklyn, NY (US)

(**) Term: **15 Years**

(21) Appl. No.: **29/581,102**

(22) Filed: **Oct. 17, 2016**

(51) **LOC (10) Cl.** **06-04**

(52) **U.S. Cl.**
USPC **D6/667**

(58) **Field of Classification Search**
USPC D6/384, 515, 663, 667, 671, 671.1,
D6/675.1; D3/269, 296, 304, 307, 309;
(Continued)

(56) **References Cited**

U.S. PATENT DOCUMENTS

310,088 A * 12/1884 Sherry E04B 2/14
52/270
D21,631 S * 6/1892 Crossley D25/113
(Continued)

OTHER PUBLICATIONS

“Sale Black Watch Display Case Large . . .” Jul. 19, 2013, etsy.com, site visited Oct. 10, 2017 <https://www.etsy.com/listing/170593689/sale-black-watch-display-case-large?ga_order=most_relevant&ga_search_type=all&ga_view_type=gallery&ga_search_query=black%20jewelry%20box&ref=sr_gallery_31> (Year: 2013).*

(Continued)

Primary Examiner — Kevin K Rudzinski

Assistant Examiner — Paul D Bohannon

(74) *Attorney, Agent, or Firm* — Baker and Rannells, PA

(57) **CLAIM**

The ornamental design for a jewelry box, as shown and described.

DESCRIPTION

FIG. 1 is a perspective view of a first embodiment of a jewelry box in accordance with the new design, whereby the box is in a closed configuration;
FIG. 2 is a front elevational view thereof;
FIG. 3 is a rear elevational view thereof;
FIG. 4 is a right side elevational view thereof, whereby, the opposite left side is a mirror image thereof;
FIG. 5 is a top plan view thereof;
FIG. 6 is a bottom view thereof;
FIG. 7 is a perspective view of the first embodiment of a jewelry box in accordance with the new design, showing the box in an opened configuration; wherein the lid is open;
FIG. 8 is a top plan view thereof;
FIG. 9 is a perspective view of the first embodiment of a jewelry box in accordance with the new design, showing the box in an opened configuration, wherein the lid and drawer are open;
FIG. 10 is a top plan view thereof;
FIG. 11 is a perspective view of a second embodiment of a jewelry box in accordance with the new design, whereby the box is in a closed configuration;
FIG. 12 is a front elevational view thereof;
FIG. 13 is a rear elevational view thereof;
FIG. 14 is a right side elevational view thereof, whereby, the opposite left side is a mirror image thereof;
FIG. 15 is a top plan view thereof;
FIG. 16 is a bottom view thereof;
FIG. 17 is a perspective view of the second embodiment of a jewelry box in accordance with the new design, showing the box in an opened configuration, wherein the lid is open;
FIG. 18 is a top plan view thereof;
FIG. 19 is a perspective view of the second embodiment of a jewelry box in accordance with the new design, showing the box is in an opened configuration, wherein the lid and drawer are open; and,
FIG. 20 is a top plan view thereof.

1 Claim, 20 Drawing Sheets

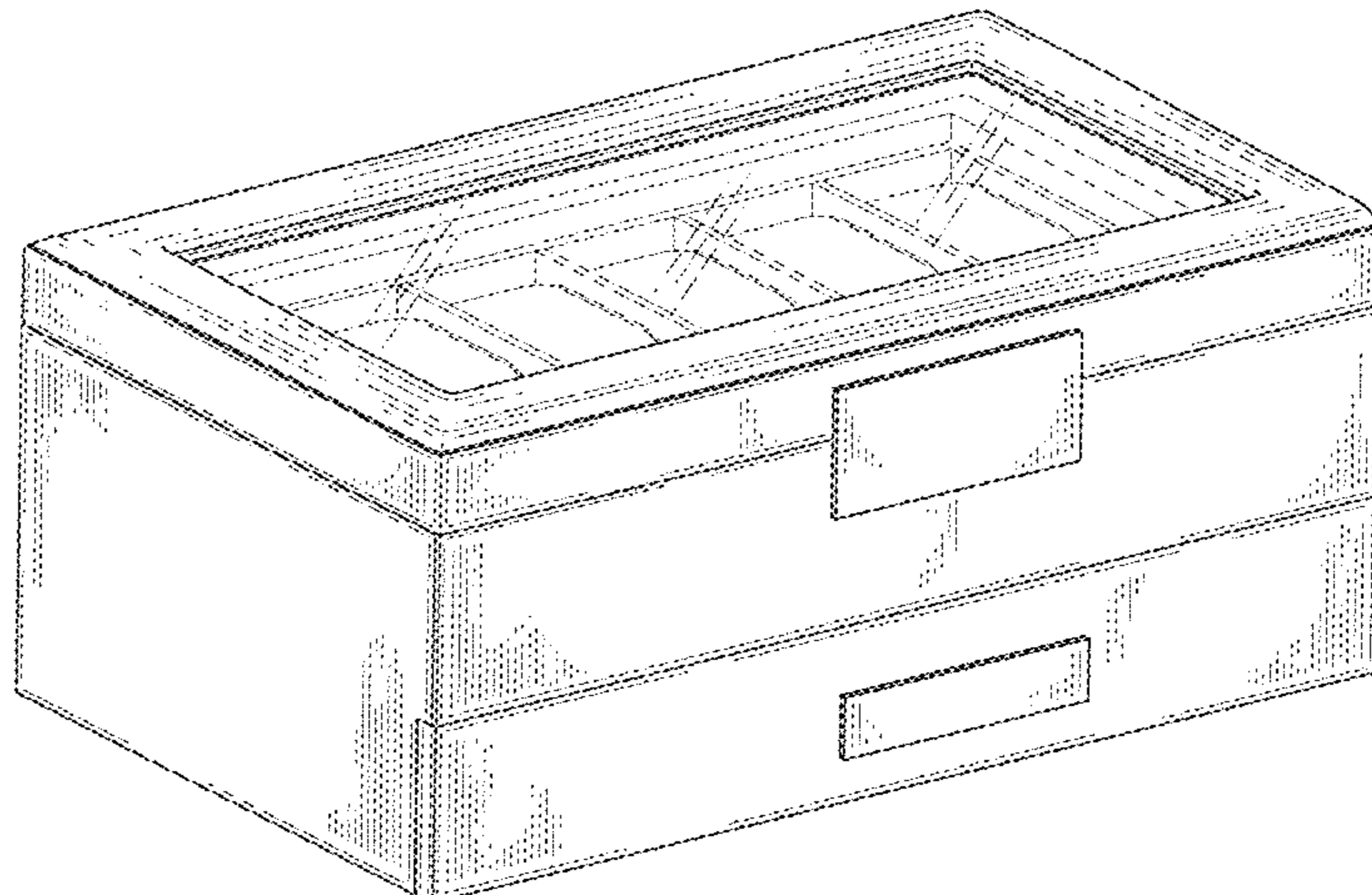

(58) **Field of Classification Search**

USPC D7/333, 368; D23/286, 343, 342;
 D24/227–230; D25/48.4, 113, 163
 CPC . A47F 3/043; A47F 7/03; A47F 7/021; A47B
 49/004; A47B 88/90; A47B 2095/024;
 F25D 23/026

See application file for complete search history.

D422,810 S * 4/2000 Rasp D6/691.4
 D423,249 S * 4/2000 Hawang D6/667
 D506,867 S * 7/2005 Galan D3/273
 D587,495 S * 3/2009 Levinger D3/295
 D613,522 S * 4/2010 Kanthasamy D6/667
 D788,462 S * 6/2017 Zhu D3/294
 2001/0017509 A1* 8/2001 Hallsten E05B 65/46
 312/333
 2003/0205577 A1* 11/2003 Au A45C 11/10
 220/9.1

(56) **References Cited**

U.S. PATENT DOCUMENTS

2,793,925 A * 5/1957 Rosen A47F 3/043
 312/139.2
 2,985,333 A * 5/1961 Kirkman A47B 88/90
 220/533
 D257,496 S * 11/1980 Berkman D6/631
 D284,424 S * 7/1986 Gotlib D3/296
 D287,800 S * 1/1987 Lance D6/559
 D334,308 S * 3/1993 Verina D3/284
 D351,073 S * 10/1994 Palka D6/671.1
 5,692,605 A * 12/1997 Lai A45C 11/16
 206/566
 D390,106 S * 2/1998 Dauphin D9/760
 D403,534 S * 1/1999 Gregory D6/559
 D416,736 S * 11/1999 Bergin D6/559

OTHER PUBLICATIONS

“Blush Shagreen Jewellery Box—Large” Mar. 9, 2016, amara.com, site visited Oct. 10, 2017 <<https://www.amara.com/products/blush-shagreen-jewellery-box-1>> (Year: 2016).*

“Ebony Watch Case Jewelry Box” Mar. 25, 2014, annsfinegiftsblog.com, site visited Oct. 10, 2017 <http://www.annsfinegiftsblog.com/img_8263/> (Year: 2014).*

“Dumena jewelry box 6 watch box storage box factory custom watch box wholesale jewelry box can be customized” Jul. 24, 2013, shop.xilu.com, site visited Oct. 10, 2017 <http://shop.xilu.com/product/0002_2013_07_24_18_7553508.html> (Year: 2013).*

* cited by examiner

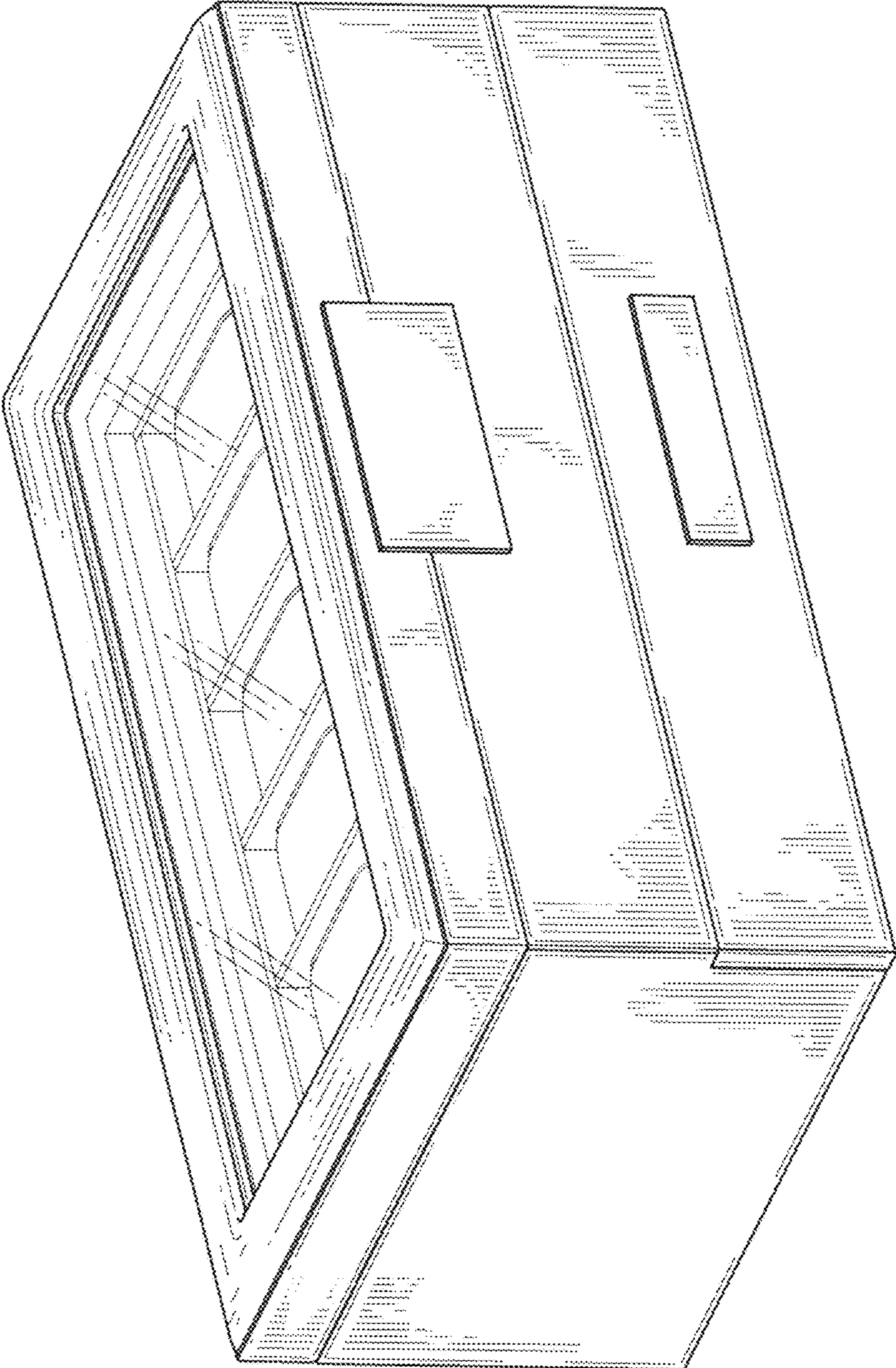

FIG. 1

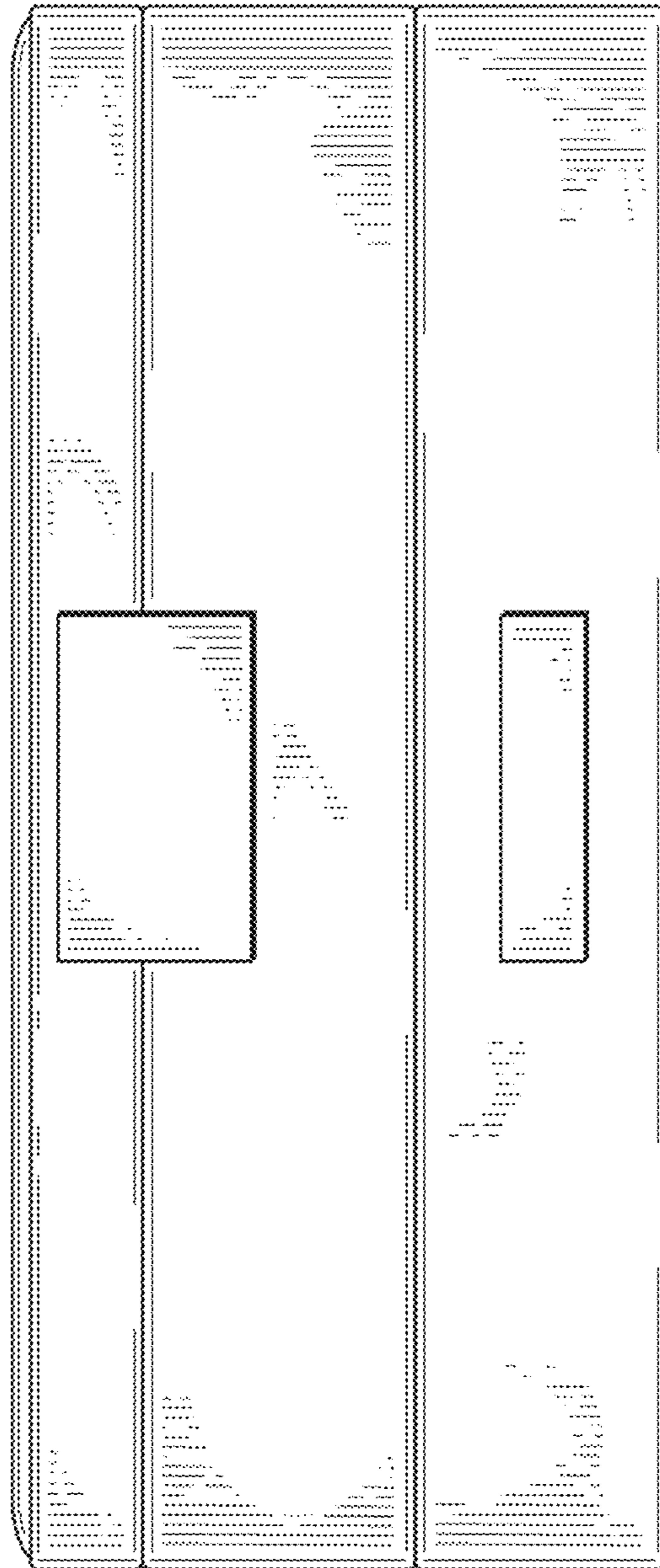

FIG. 2

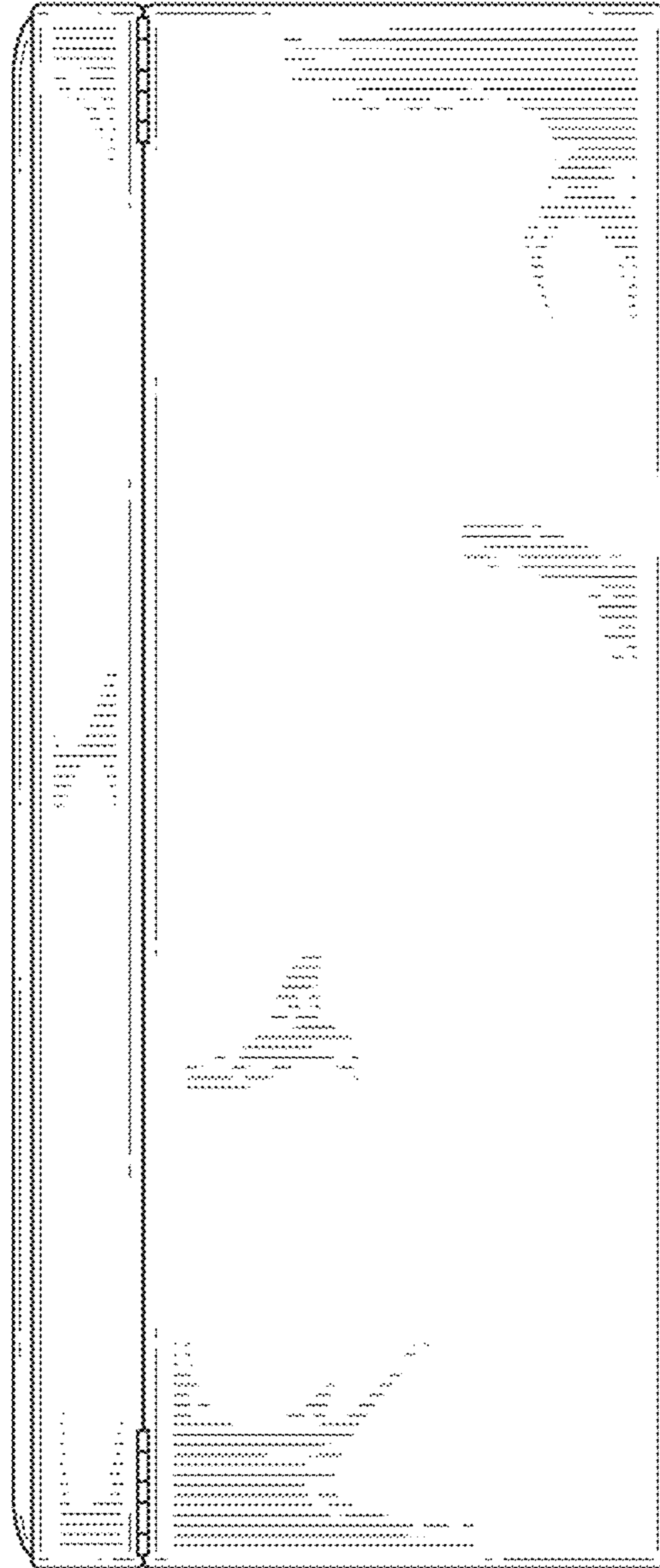

FIG. 3



FIG. 4

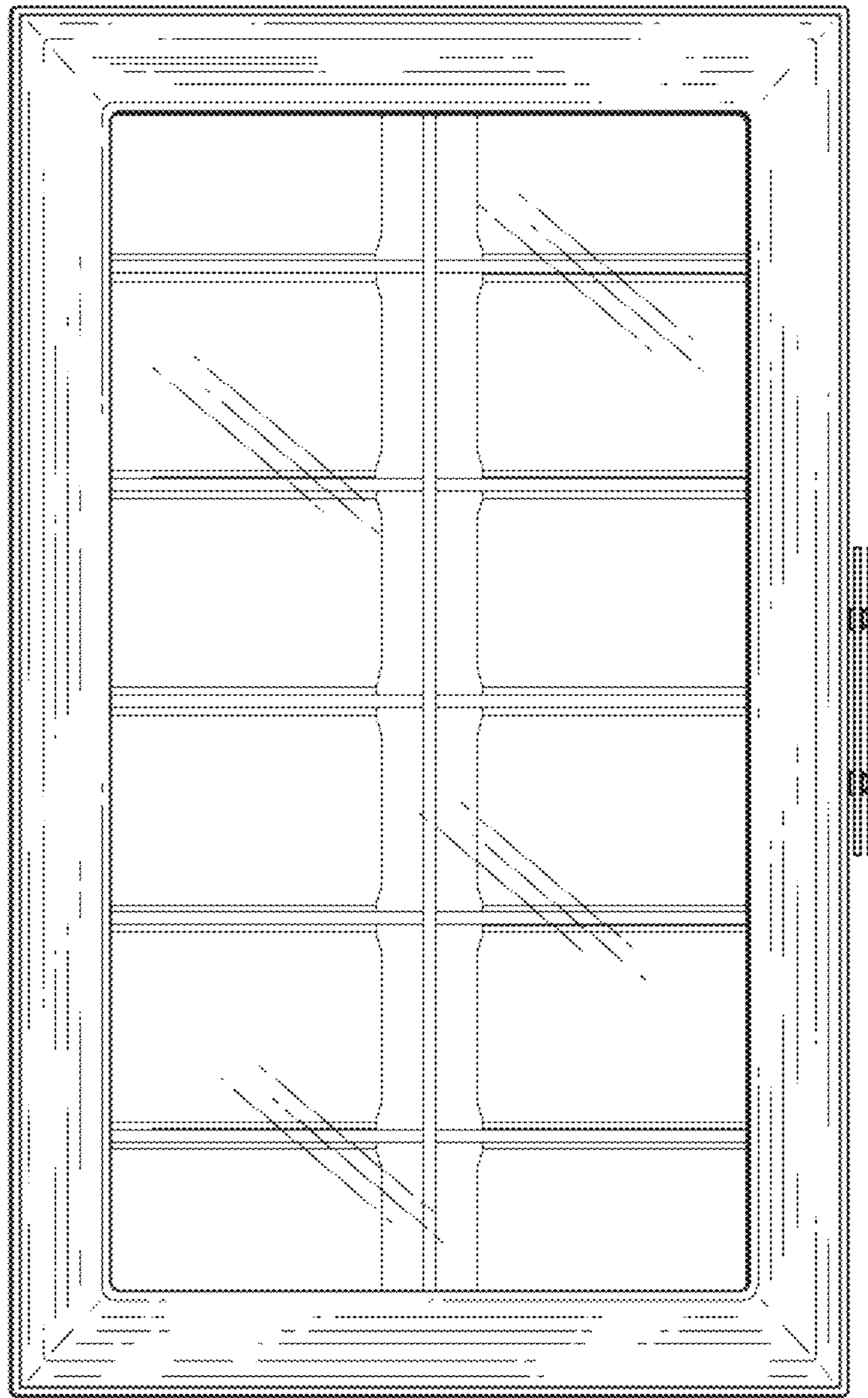

FIG. 5

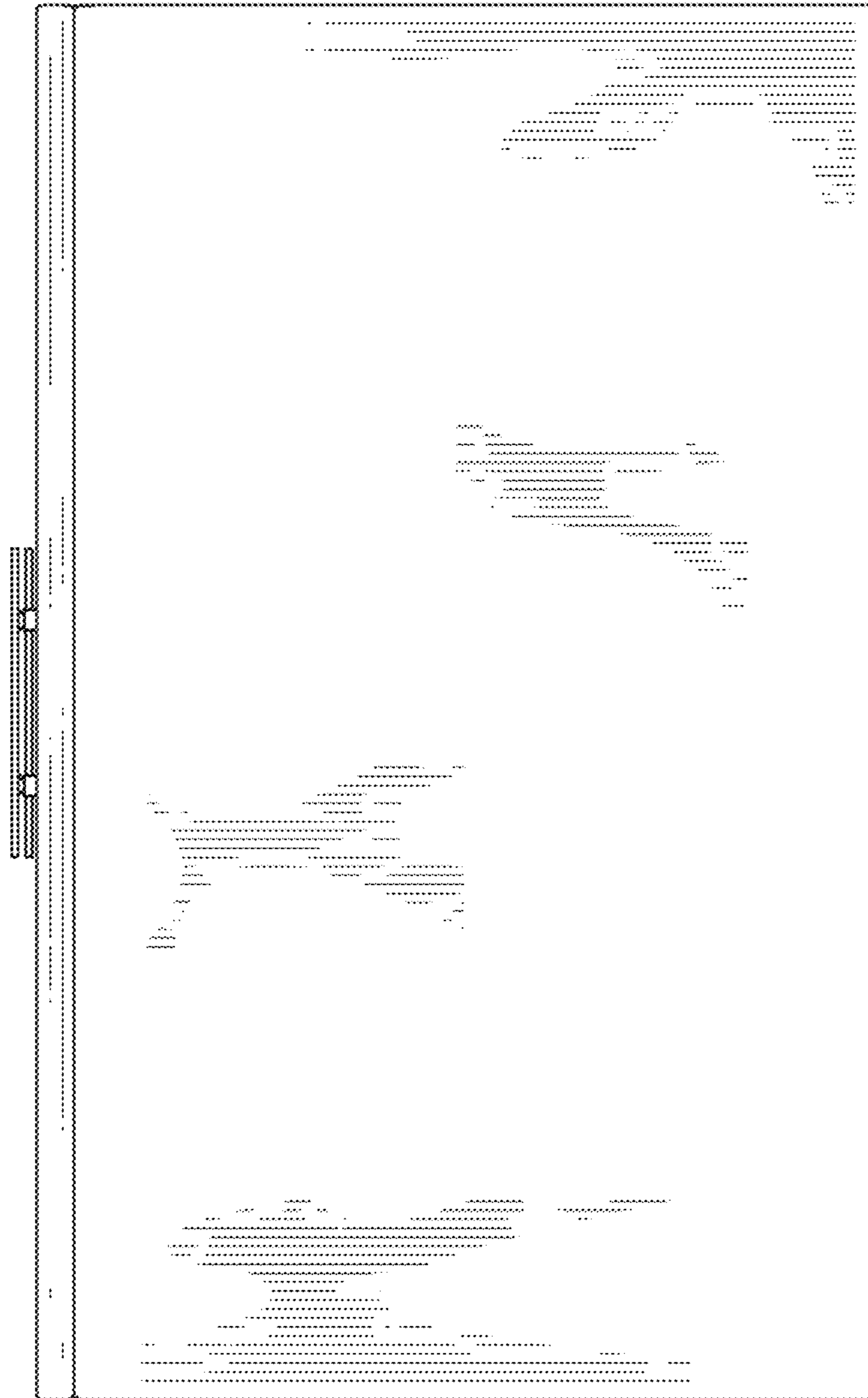

FIG. 6

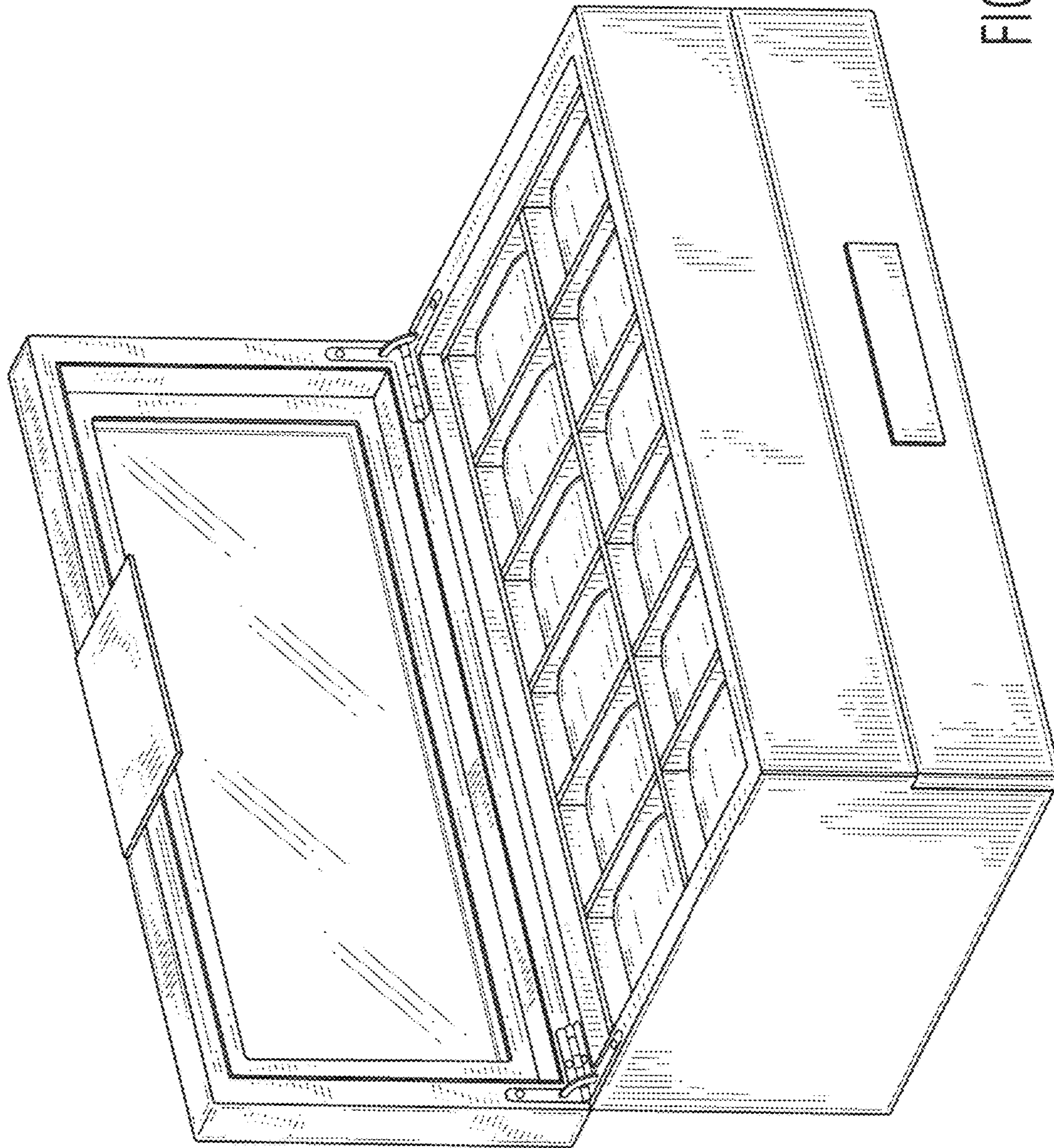

FIG. 7

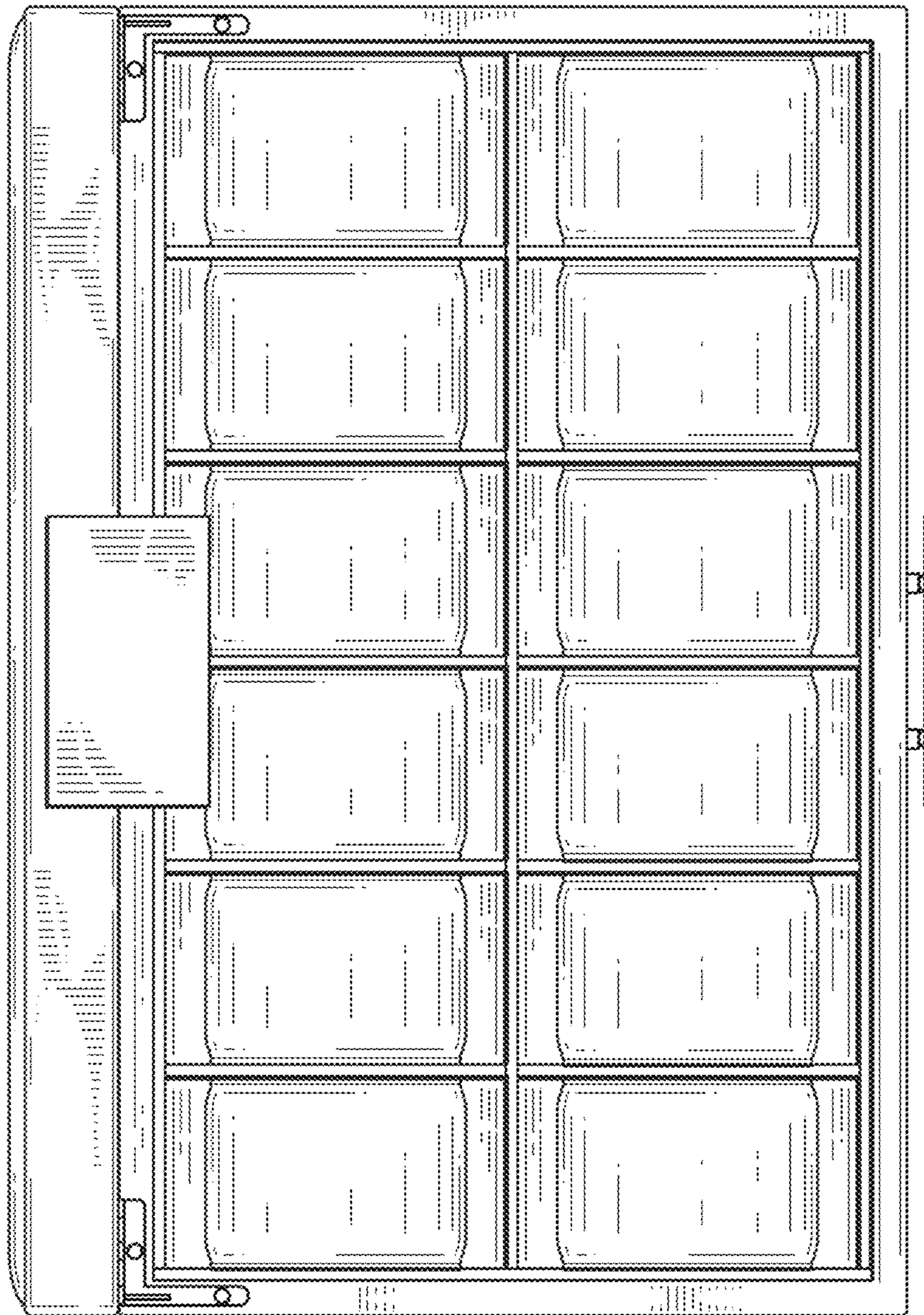

FIG. 8

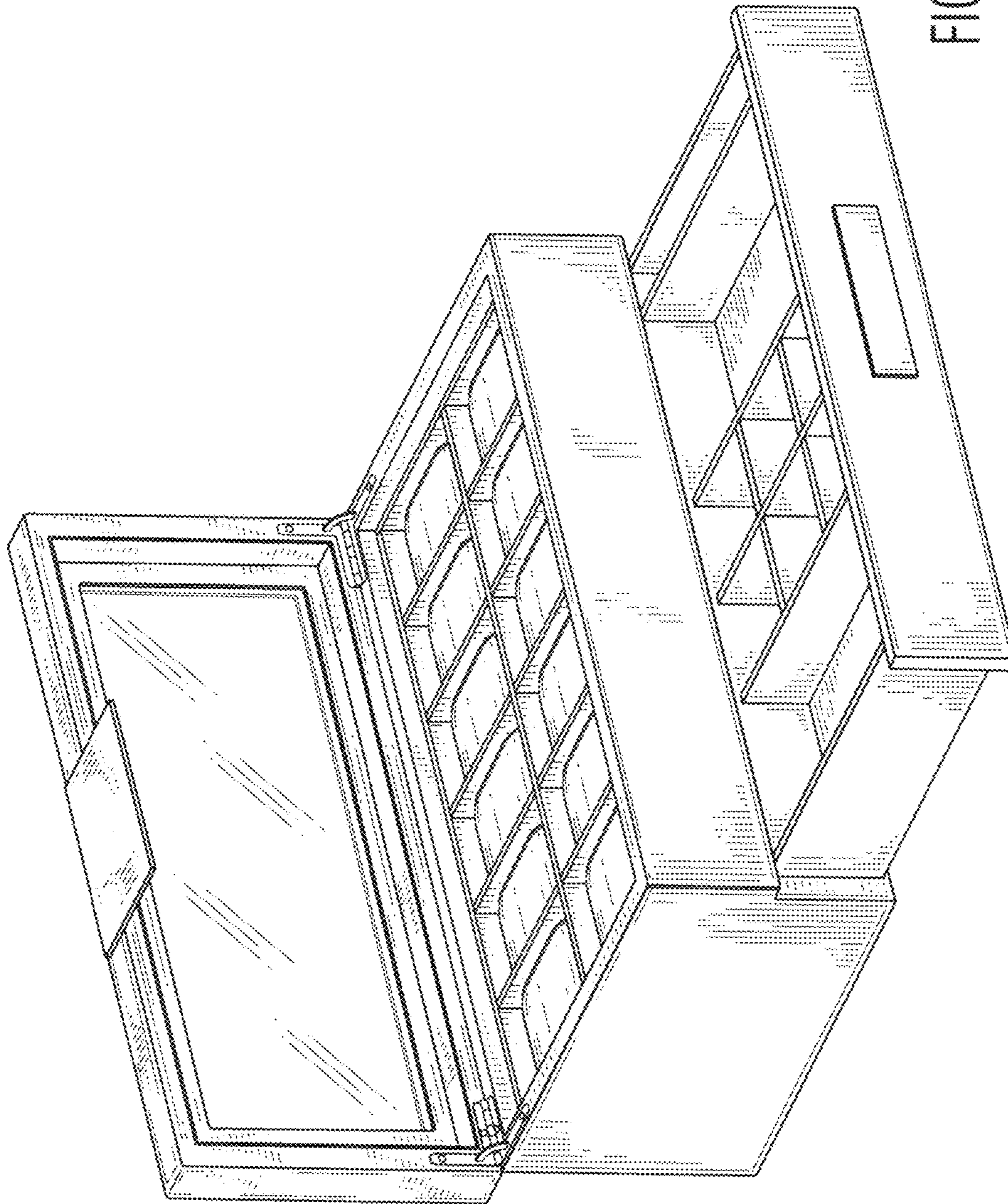

FIG. 9

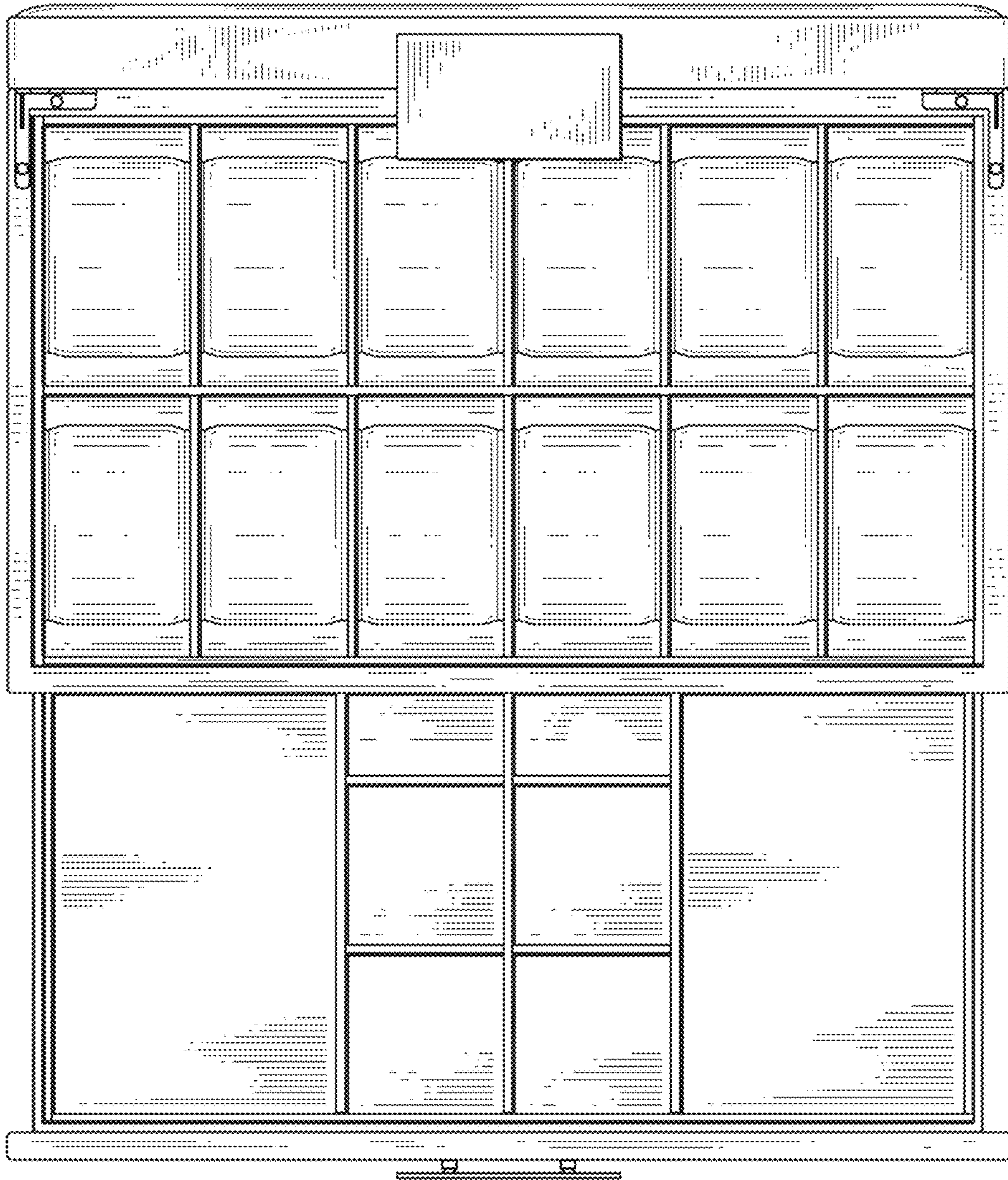

FIG. 10

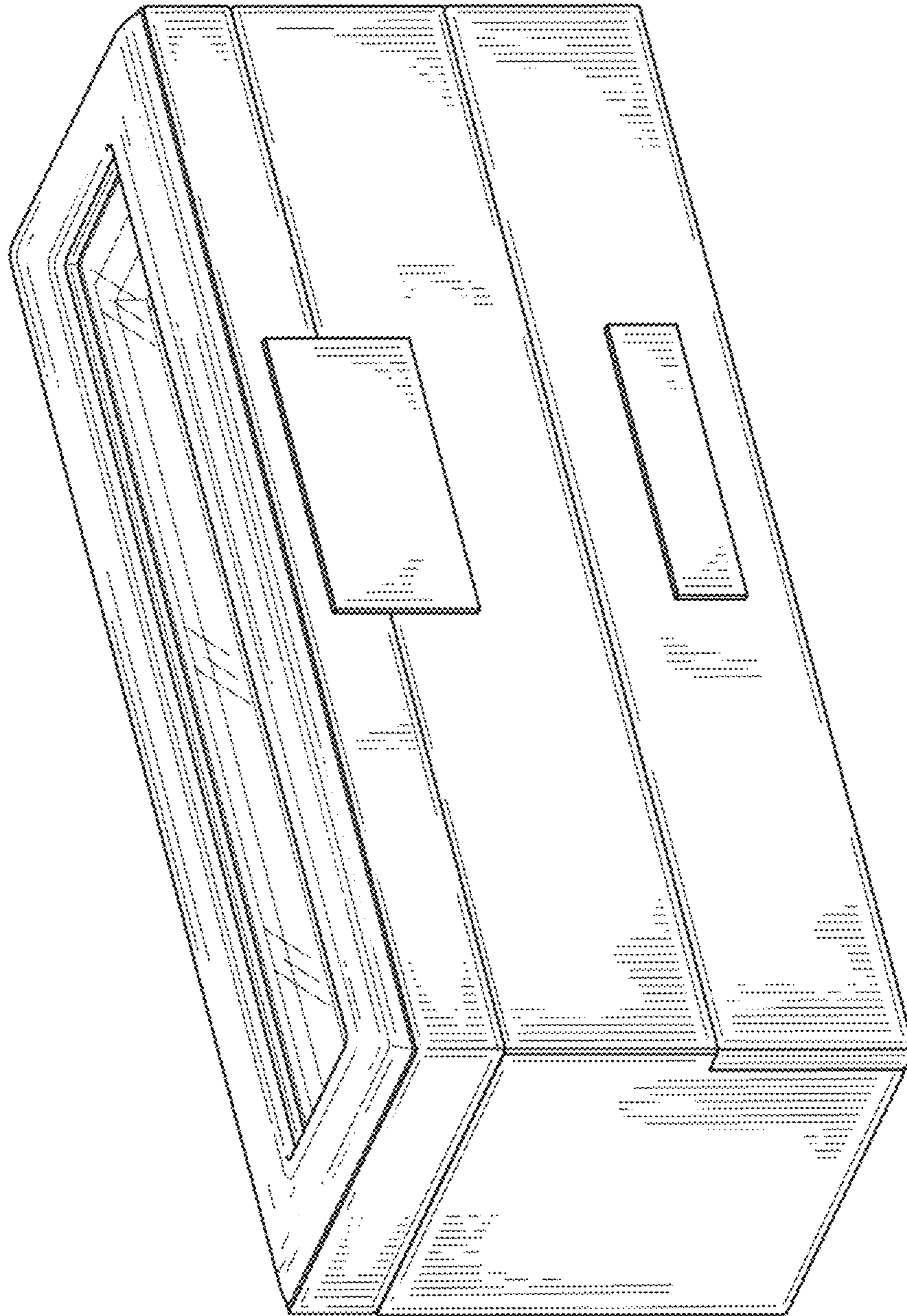

FIG. 11

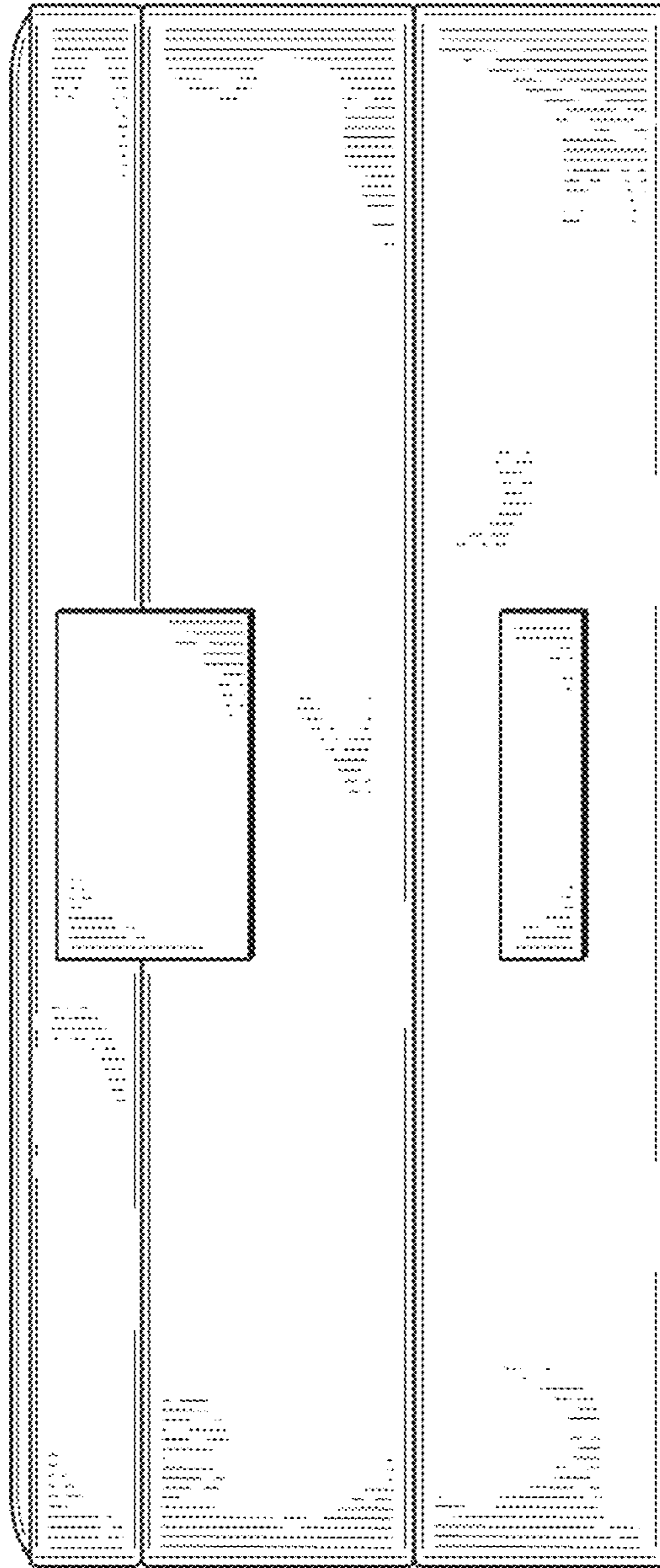

FIG. 12

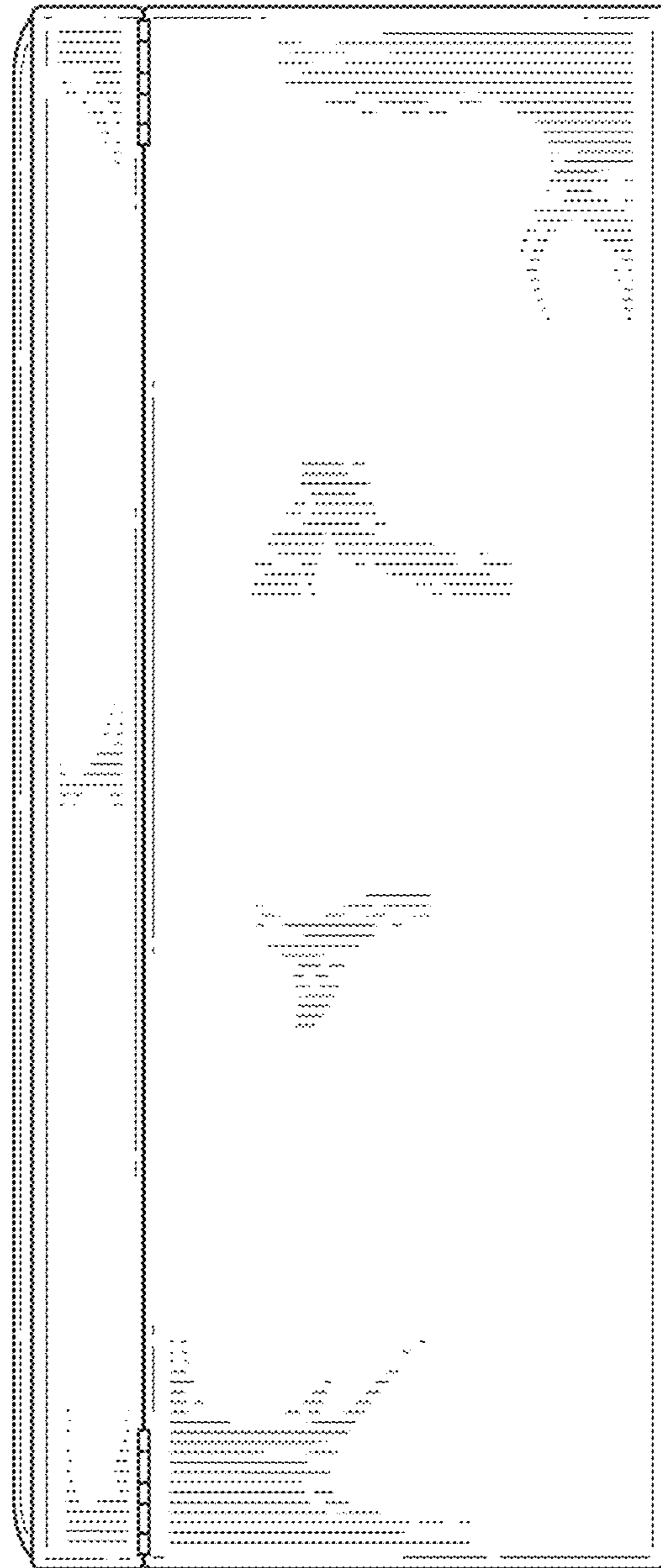

FIG. 13

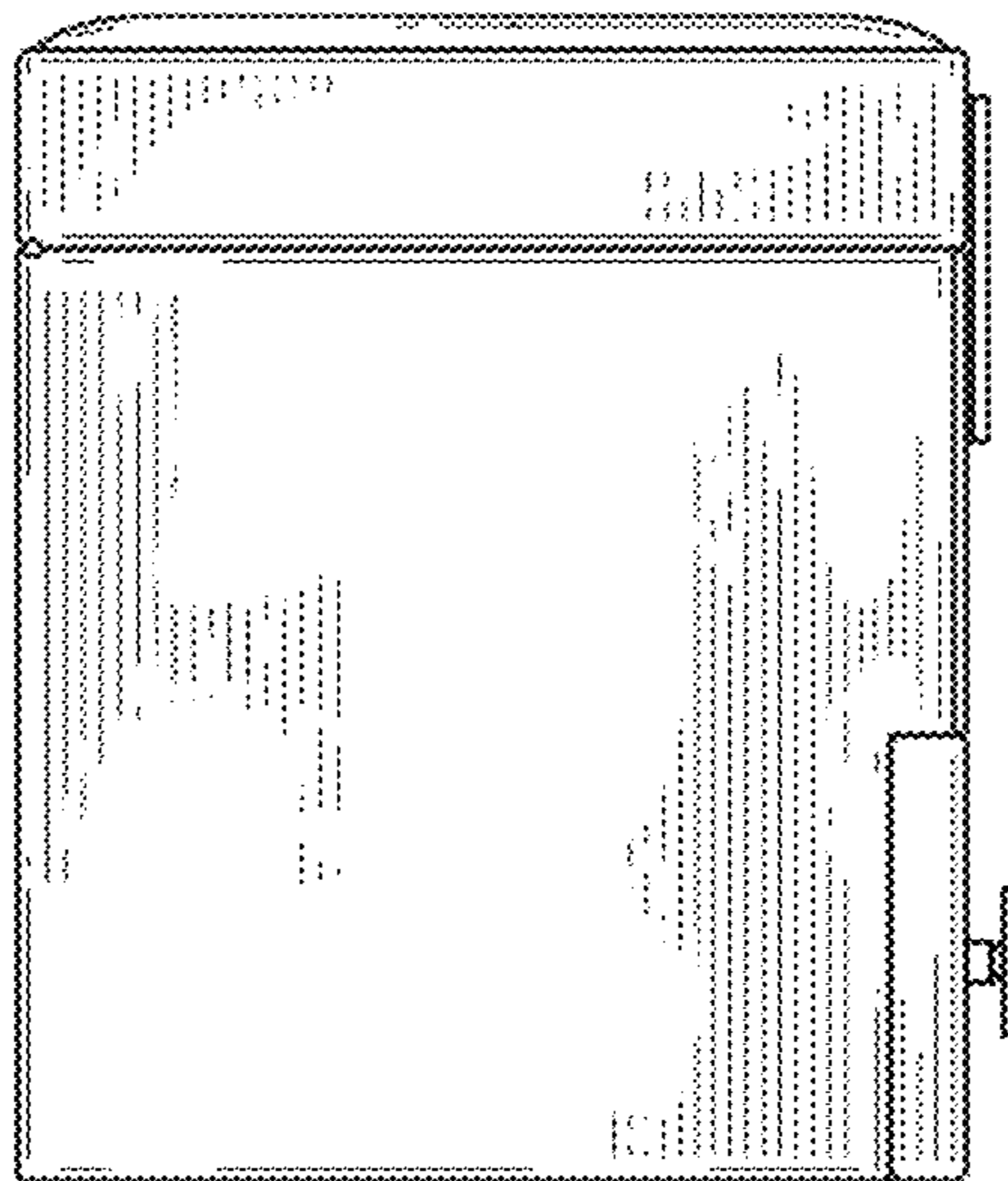

FIG. 14

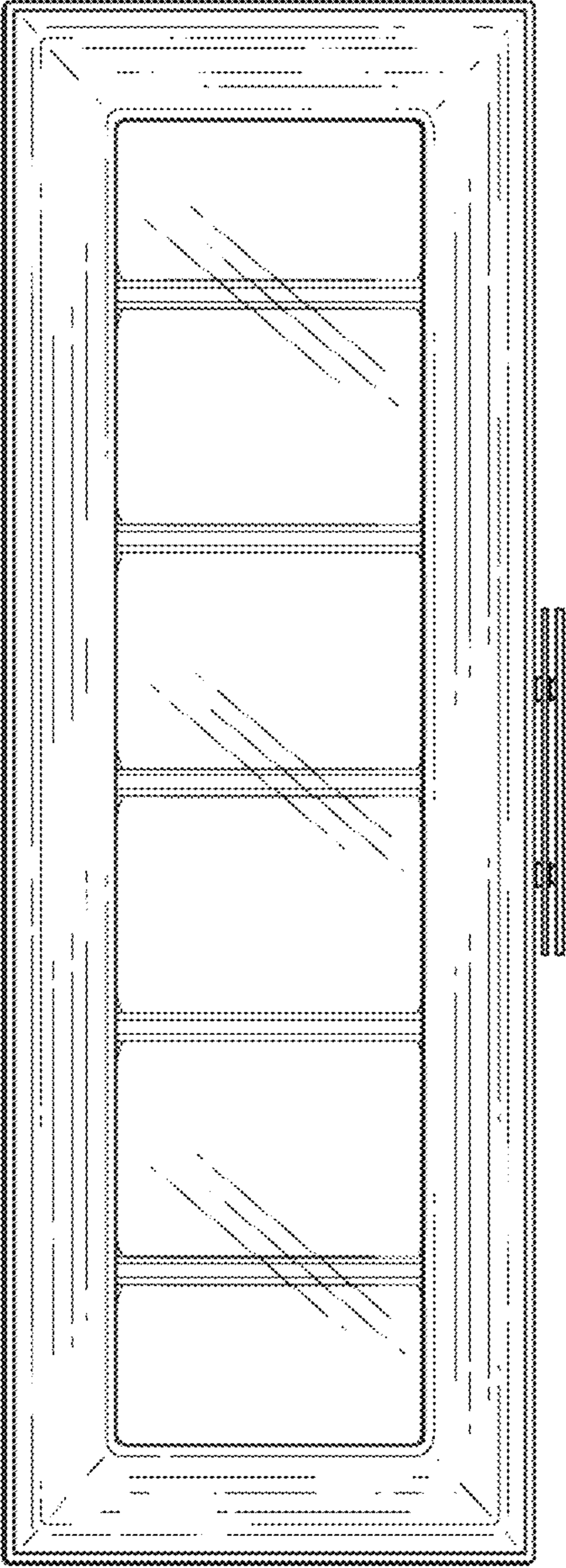

FIG. 15

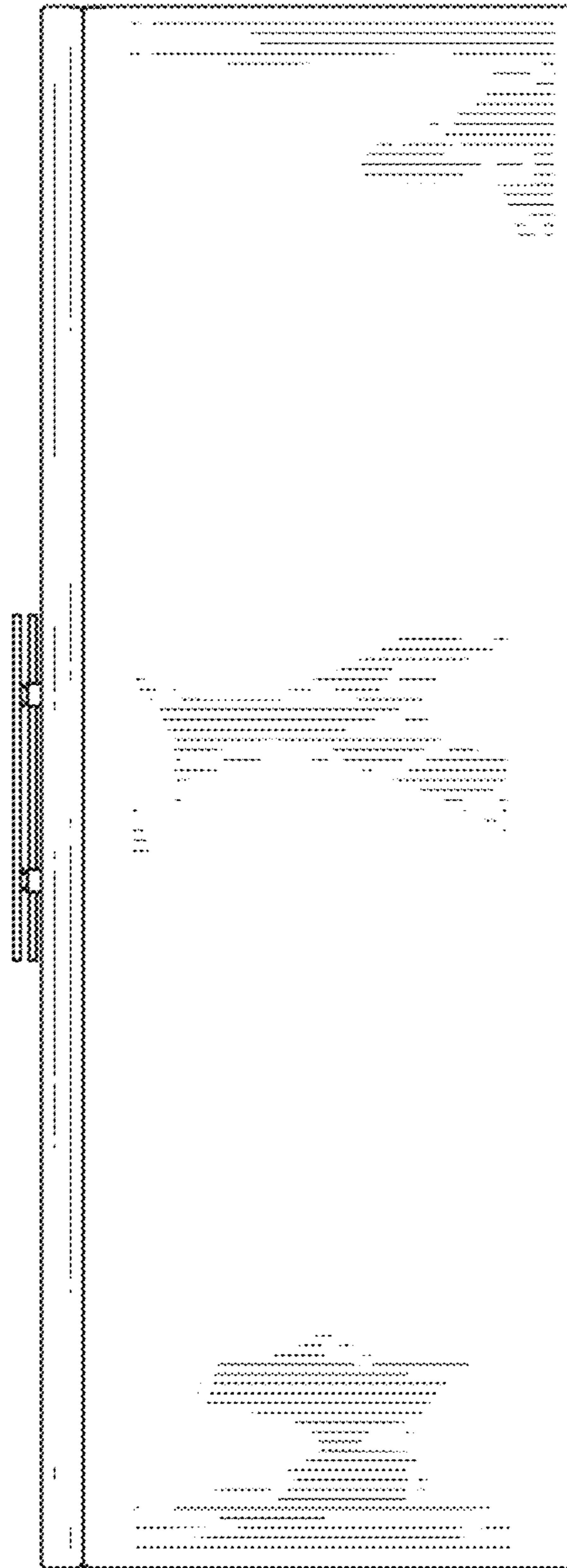

FIG. 16

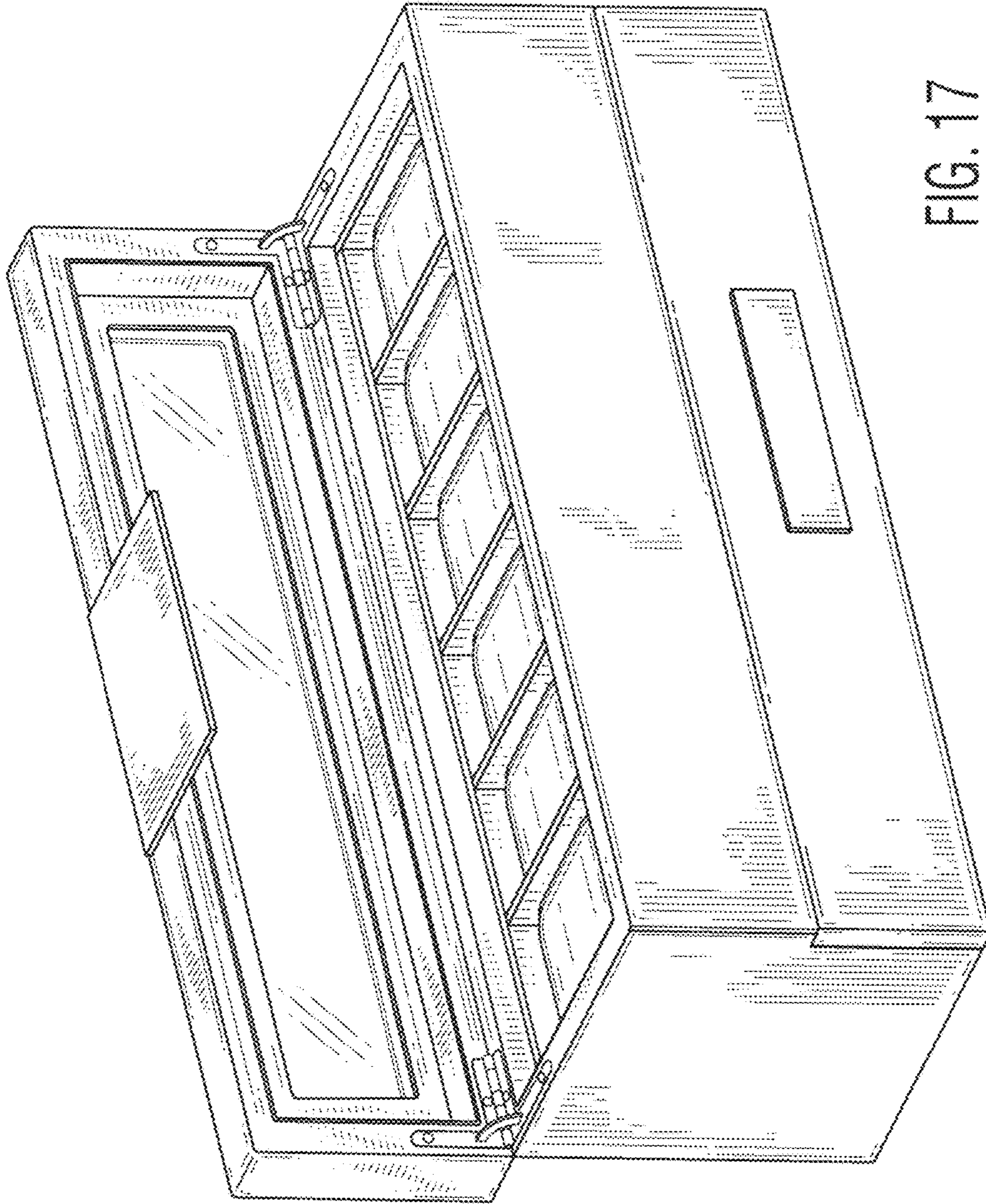

FIG. 17

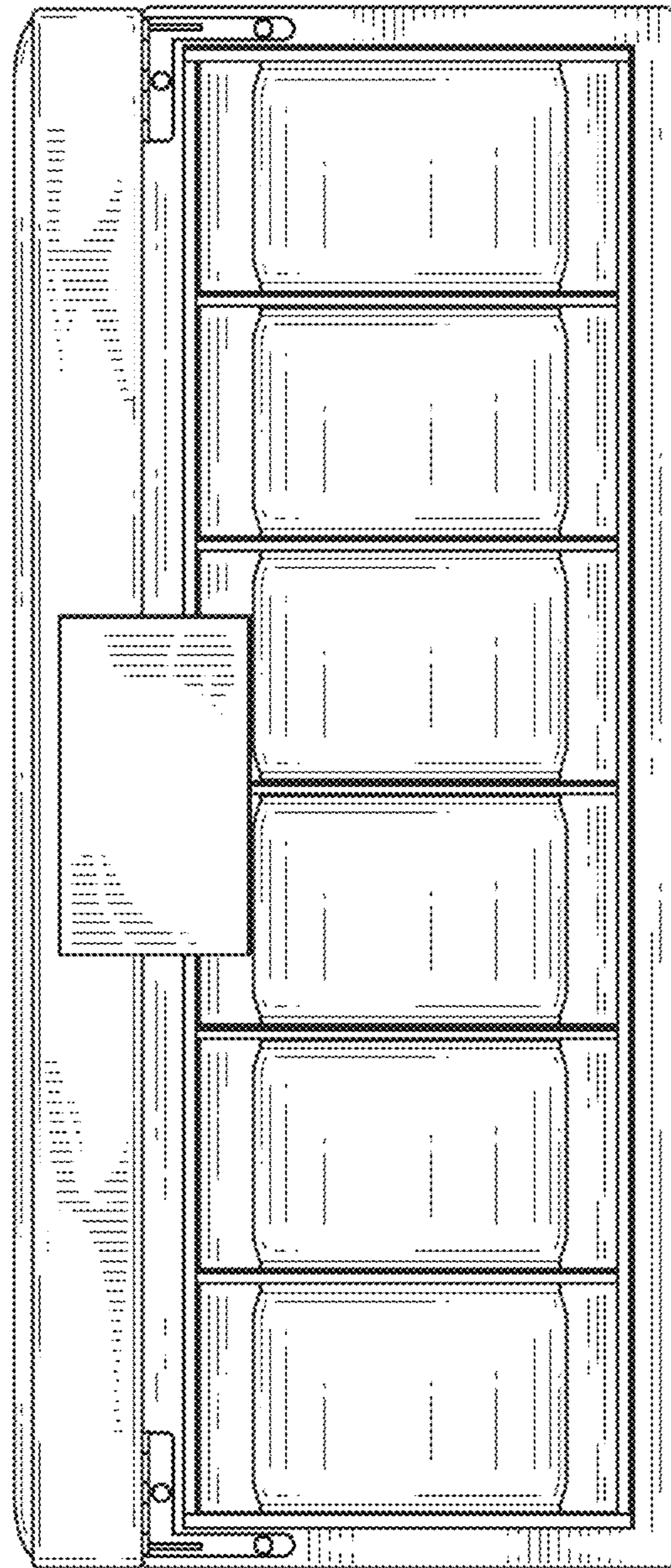

FIG. 18

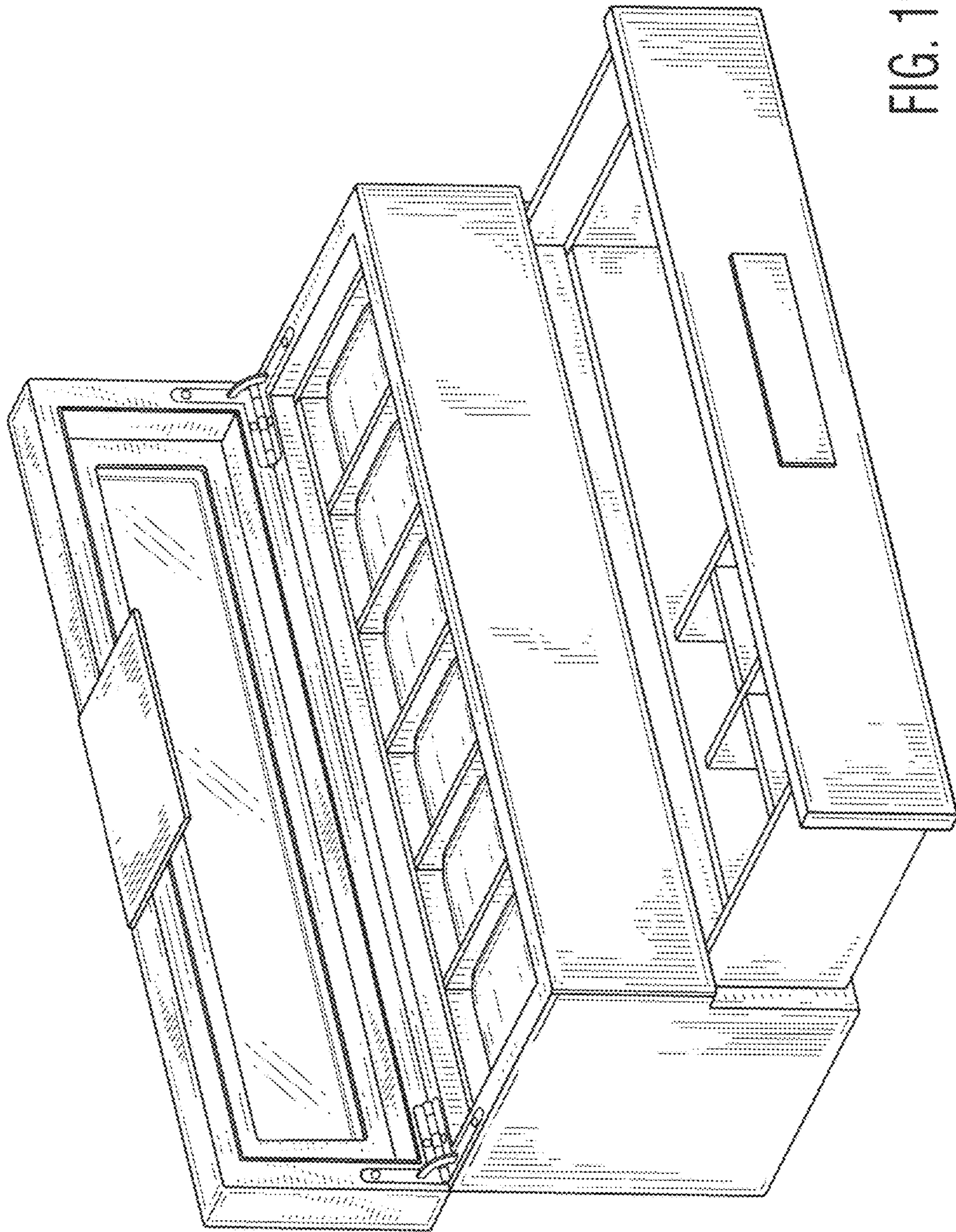

FIG. 19

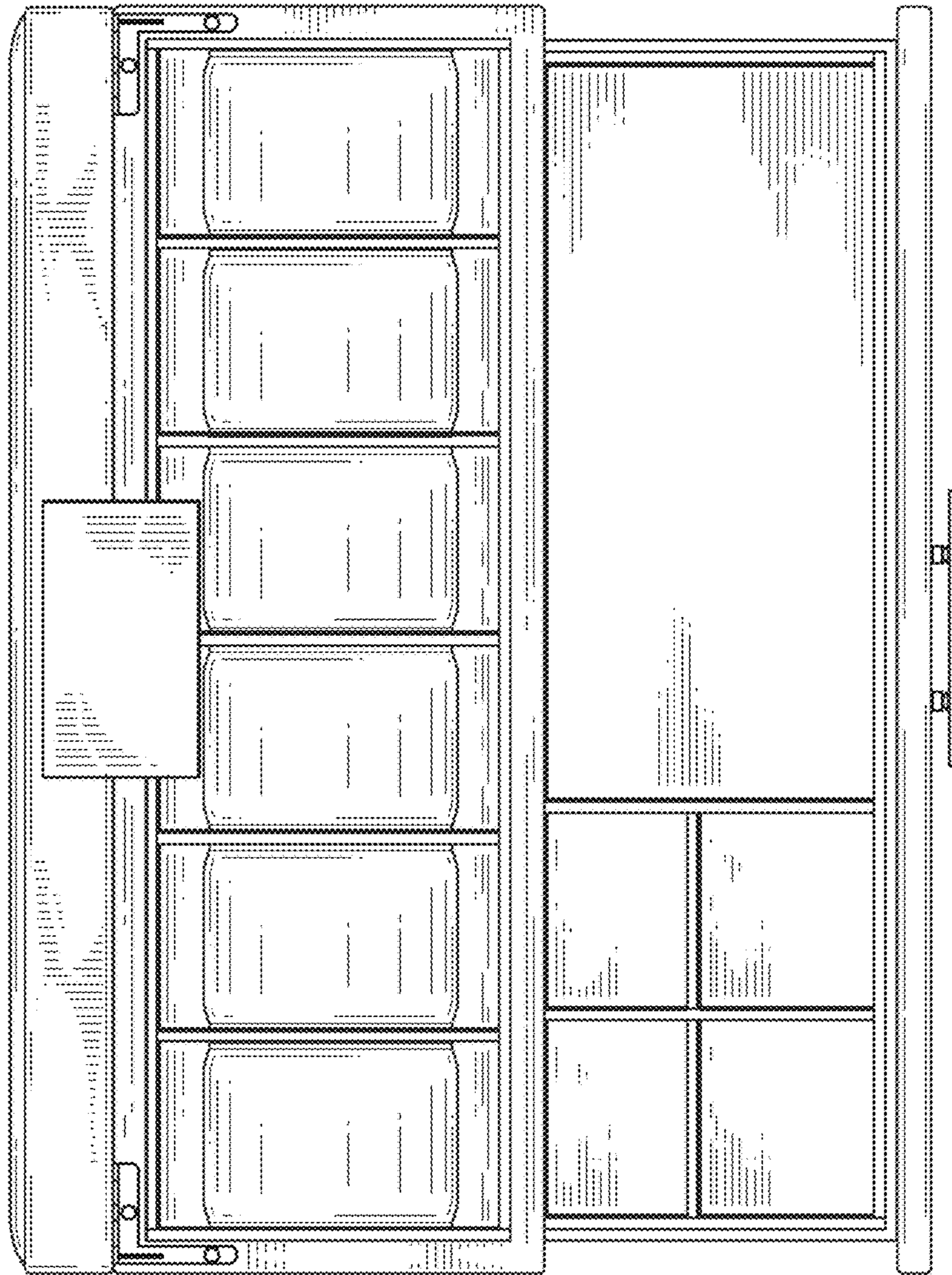

FIG. 20