



US00D805578S

(12) **United States Design Patent**  
**Mita et al.**

(10) **Patent No.:** **US D805,578 S**

(45) **Date of Patent:** **\*\* Dec. 19, 2017**

(54) **PRINTER**

(71) Applicant: **BROTHER INDUSTRIES, LTD.**,  
Nagoya-shi, Aichi-ken (JP)

(72) Inventors: **Masayoshi Mita**, Nagoya (JP); **Jihoon Kil**, Nagoya (JP); **Kowalski Marcin**,  
Nagoya (JP)

(73) Assignee: **BROTHER INDUSTRIES, LTD.**,  
Nagoya (JP)

(\*\*) Term: **15 Years**

(21) Appl. No.: **29/568,142**

(22) Filed: **Jun. 15, 2016**

(30) **Foreign Application Priority Data**

Dec. 15, 2015 (JP) ..... 2015-27908

(51) **LOC (10) Cl.** ..... **18-02**

(52) **U.S. Cl.**  
USPC ..... **D18/55**

(58) **Field of Classification Search**  
USPC ..... D18/12, 14, 18, 19, 36, 37, 38, 39, 43,  
D18/50, 54, 54.1, 55, 56, 99; D14/420,  
D14/421, 422, 423, 424, 425, 462, 463,  
D14/464, 465, 466, 467, 668, 469, 470,  
D14/480.5, 483, 484

CPC . B41J 31/16; B41J 32/02; B41J 19/202; B41J  
29/377; B41J 15/042; B41J 3/4075; B41J  
11/58; B41J 15/12; B41J 29/02; B41J  
17/00

See application file for complete search history.

(56) **References Cited**

**U.S. PATENT DOCUMENTS**

D544,906 S \* 6/2007 Alfonso ..... D18/55  
D639,847 S \* 6/2011 Nakata ..... D18/50

D653,703 S \* 2/2012 Seki ..... D18/55  
D653,704 S \* 2/2012 Seki ..... D18/55  
D697,964 S \* 1/2014 Fukasawa ..... D18/55  
D697,965 S \* 1/2014 Fukasawa ..... D18/55  
D722,339 S \* 2/2015 Nakagawa ..... D18/55  
D725,184 S \* 3/2015 Kim ..... D18/55  
D749,169 S 2/2016 Kil et al.  
D749,170 S 2/2016 Nakagawa et al.  
D749,171 S 2/2016 Nakagawa et al.  
D749,172 S 2/2016 Nakagawa et al.  
D765,772 S \* 9/2016 Clark, III ..... D18/55  
D771,183 S \* 11/2016 Kim ..... D18/55

**OTHER PUBLICATIONS**

HLL5100DN Black & white printer, [online], [site visited Feb. 25, 2017]. Available from Internet, <URL: <http://www.brother.co.nz/Public/ViewProduct/HLL5100DN>>.\*  
Kil, et al, Design U.S. Appl. No. 29/540,441.

\* cited by examiner

*Primary Examiner* — Caron D Veynar

*Assistant Examiner* — Katrina N Gonzalez

(74) *Attorney, Agent, or Firm* — Oliff PLC

(57) **CLAIM**

The ornamental design for a printer, as shown and described.

**DESCRIPTION**

FIG. 1 is a perspective view of a printer;  
FIG. 2 is a front view thereof;  
FIG. 3 is a top view thereof;  
FIG. 4 is a right-side view thereof;  
FIG. 5 is a left-side view thereof;  
FIG. 6 is a rear view thereof; and,  
FIG. 7 is a bottom view thereof.

The broken lines are shown for the purpose of describing parts of the article that form no part of the claim.

**1 Claim, 7 Drawing Sheets**

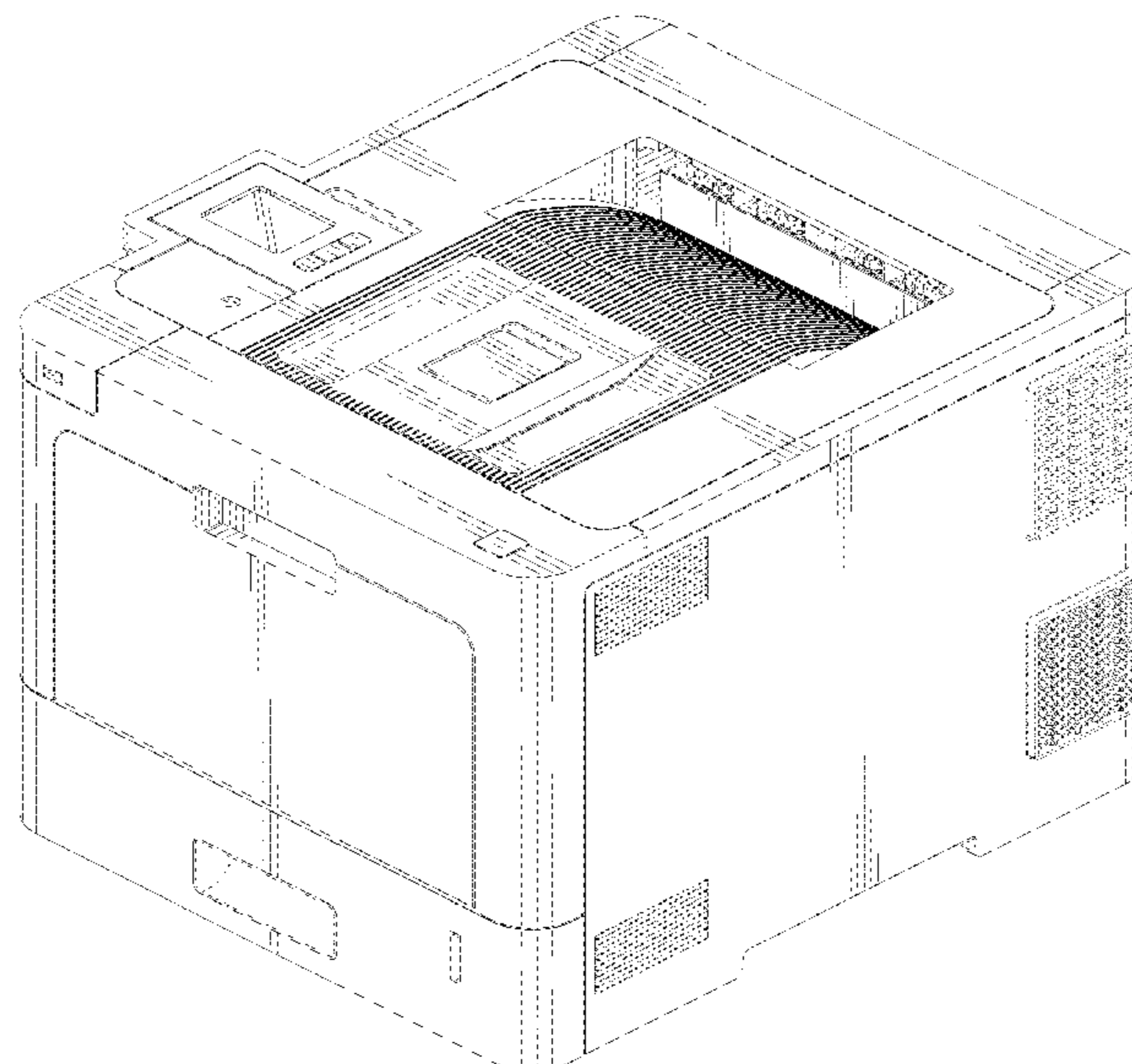

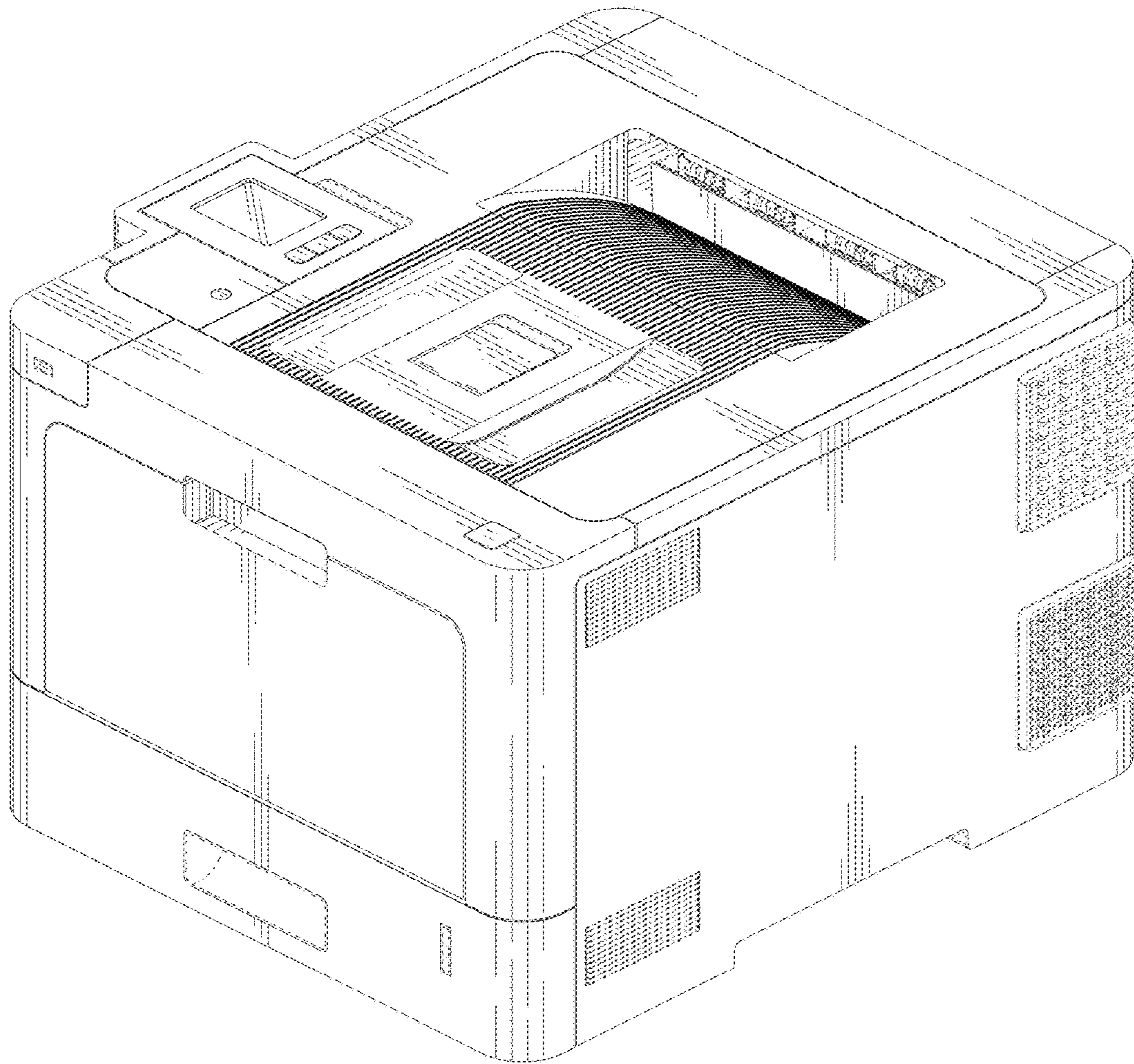

FIG. 1

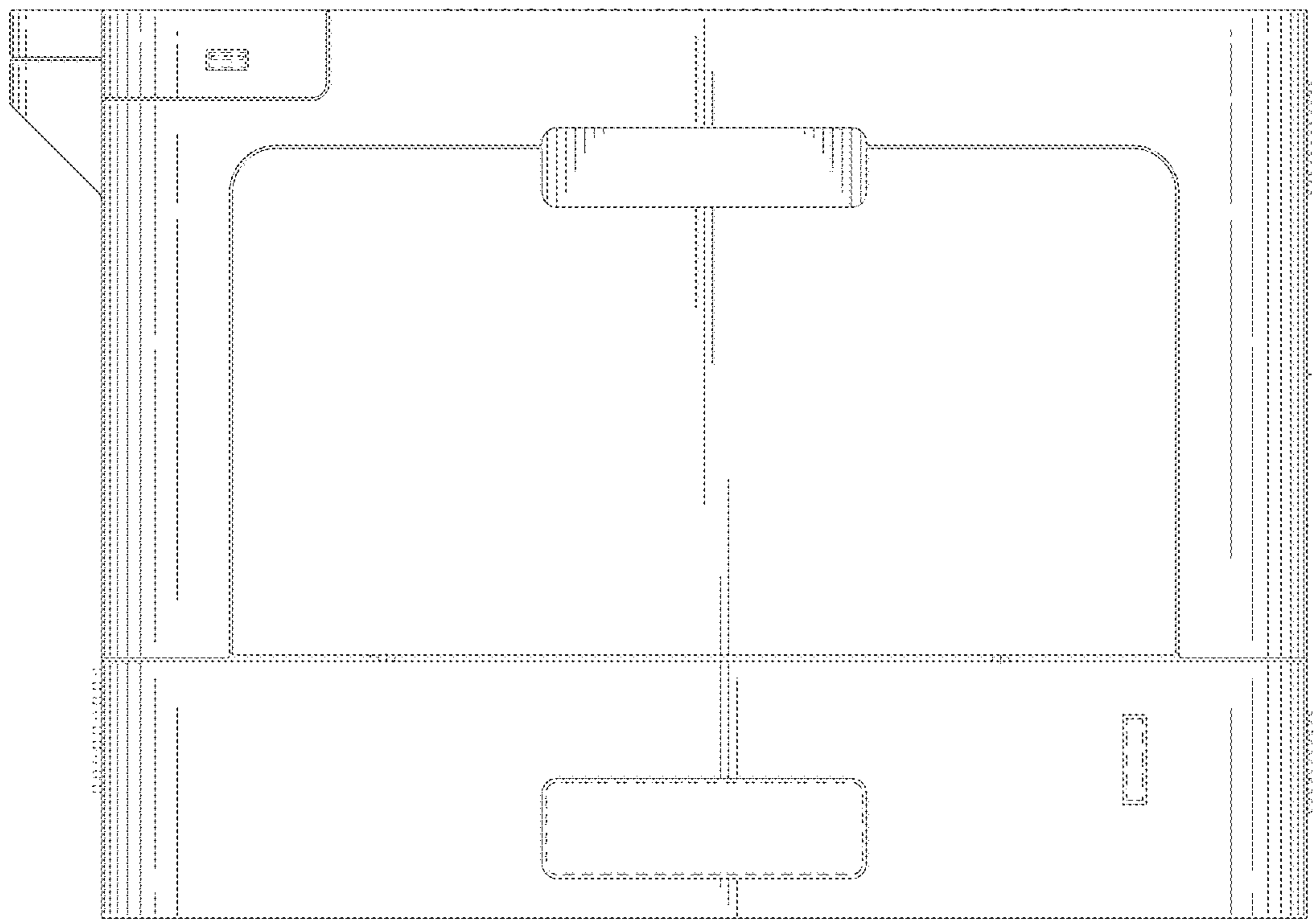

FIG. 2

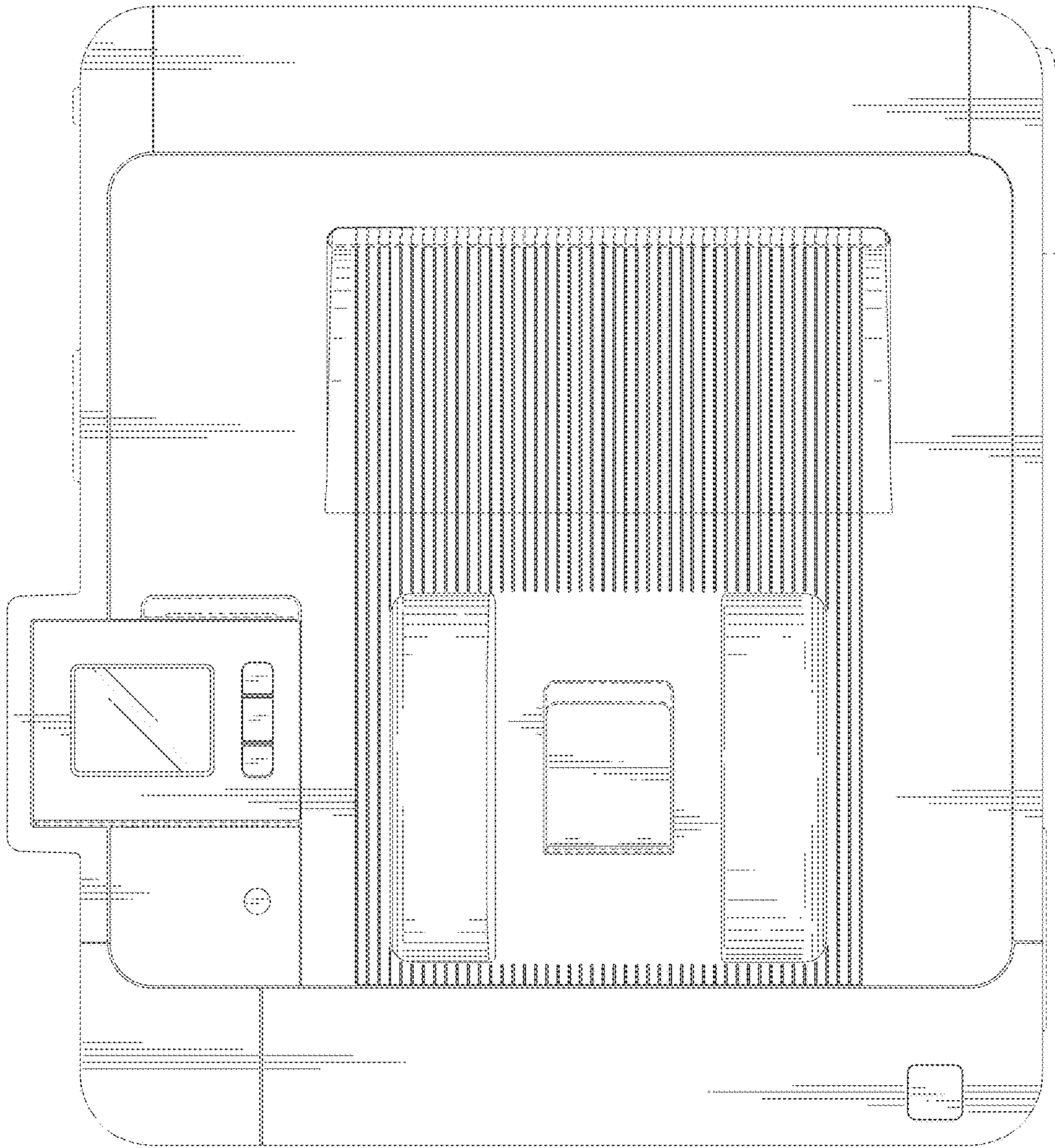

FIG. 3

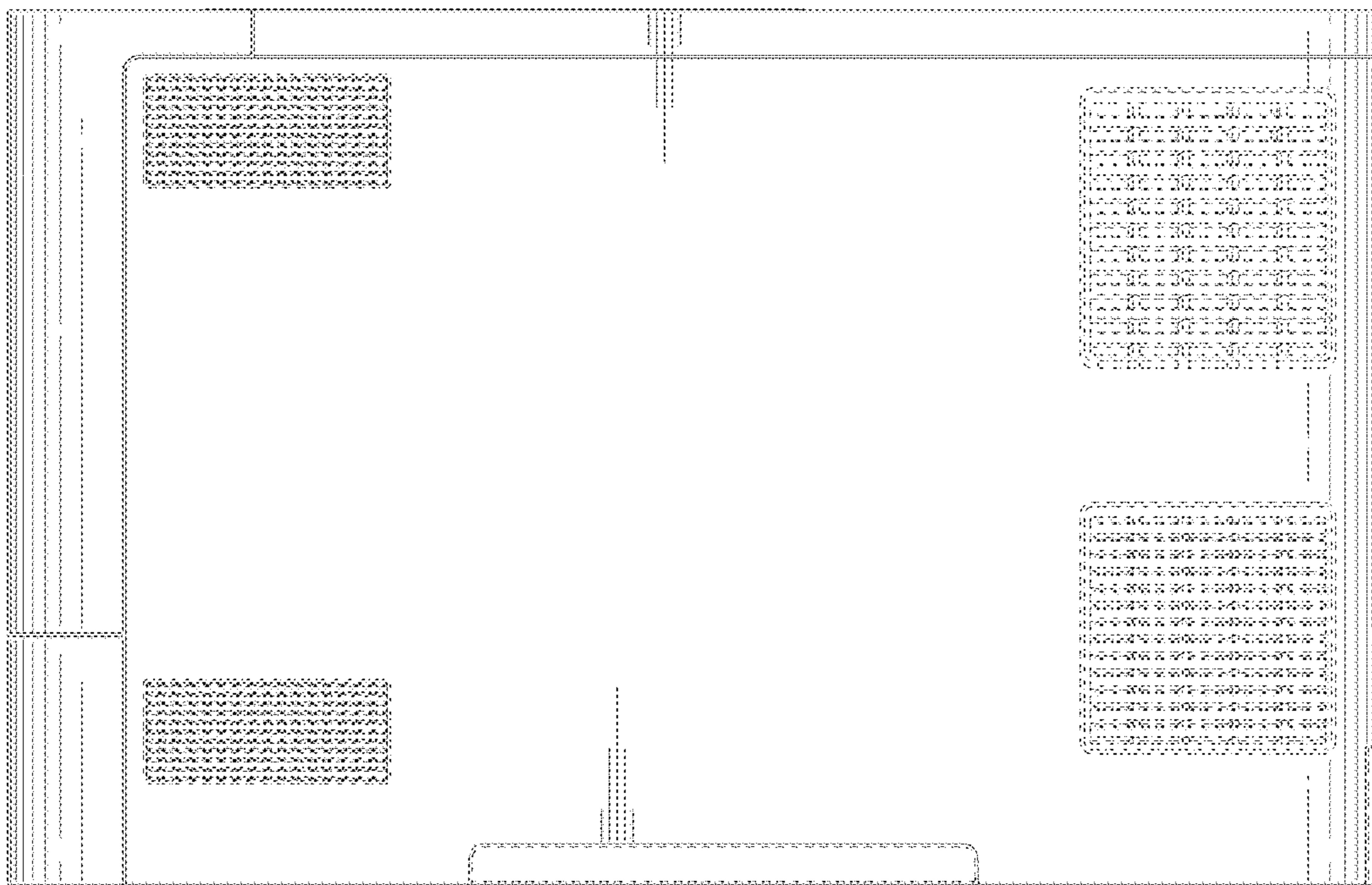

FIG. 4

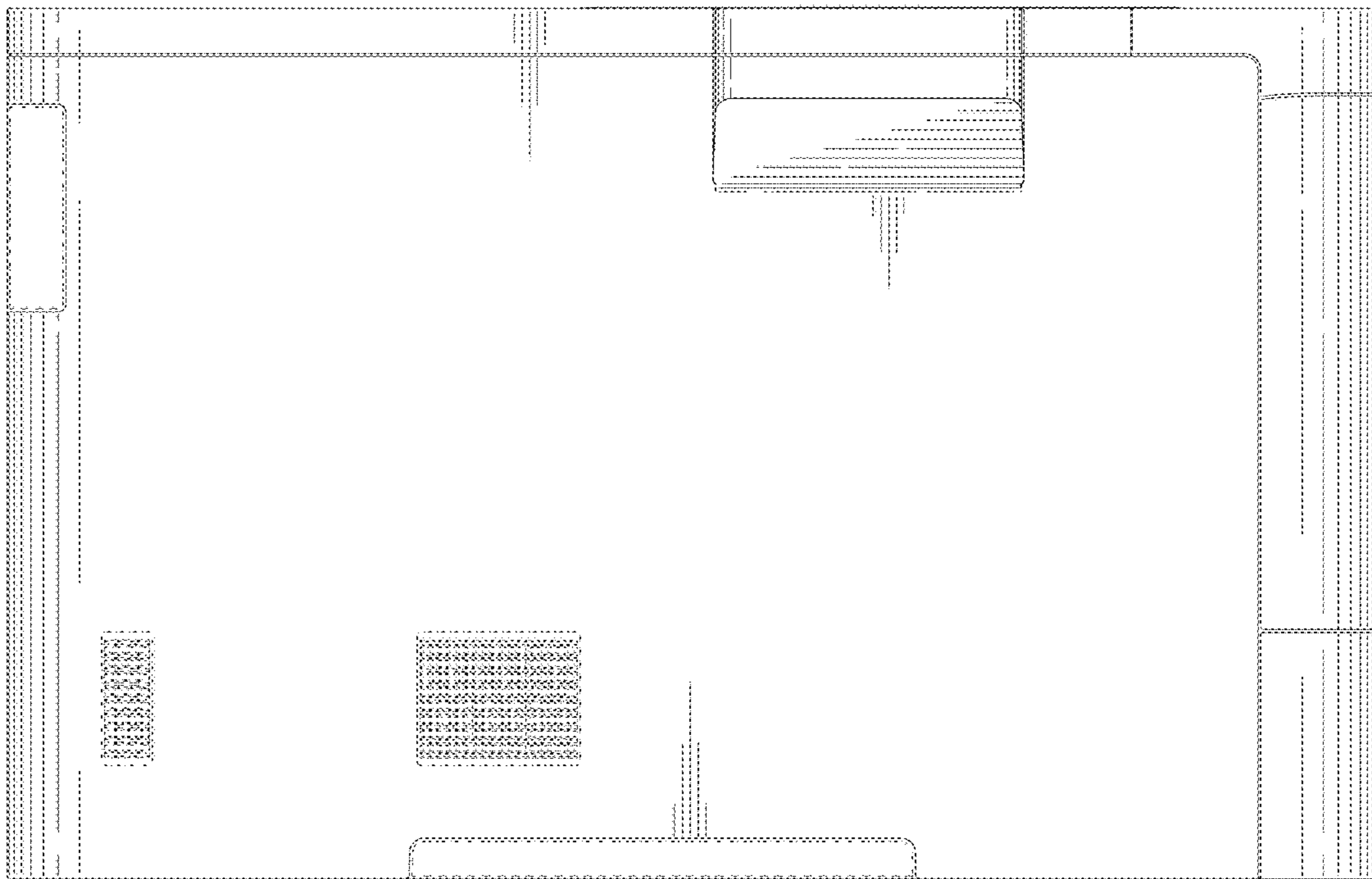

FIG. 5

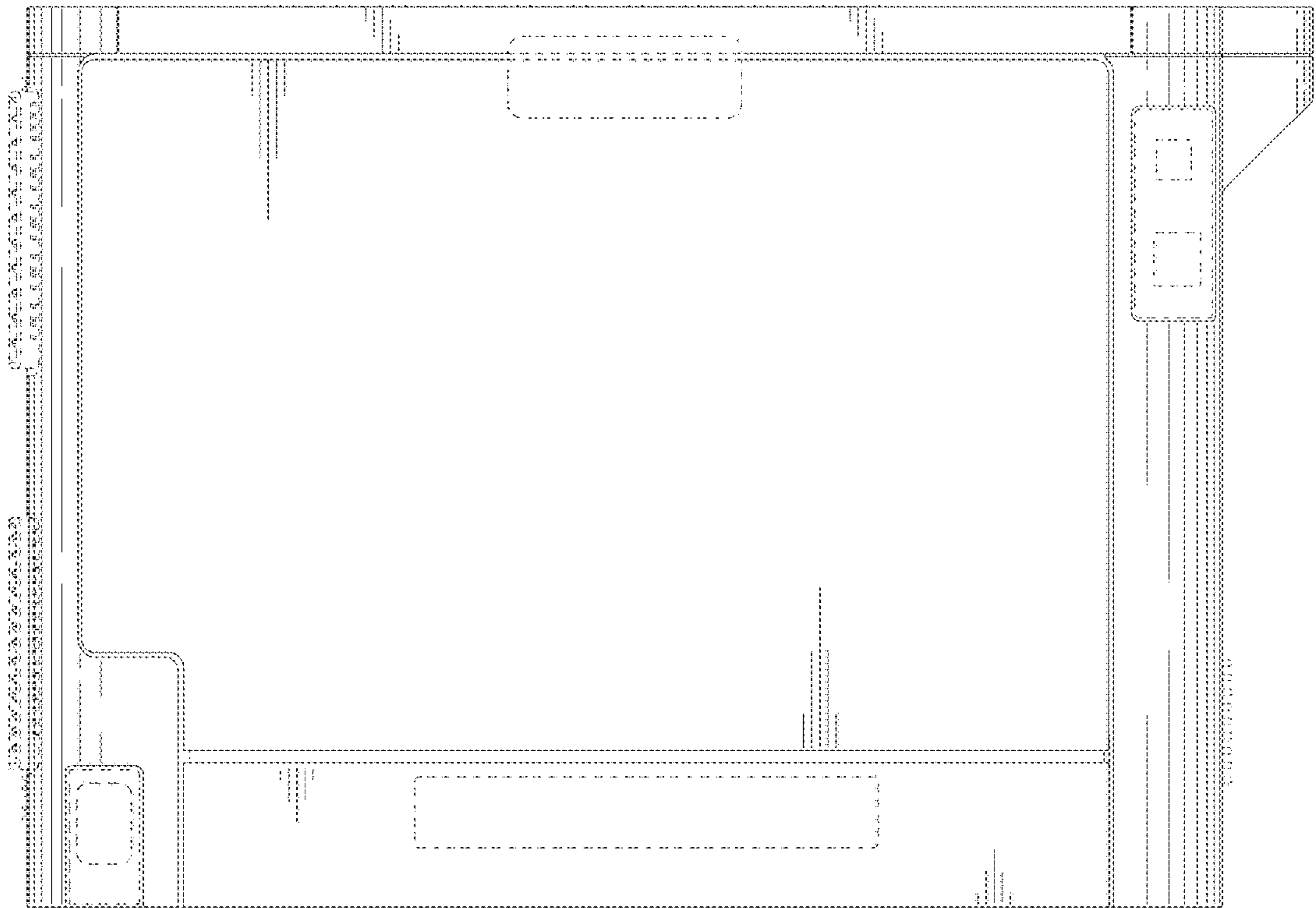

FIG. 6

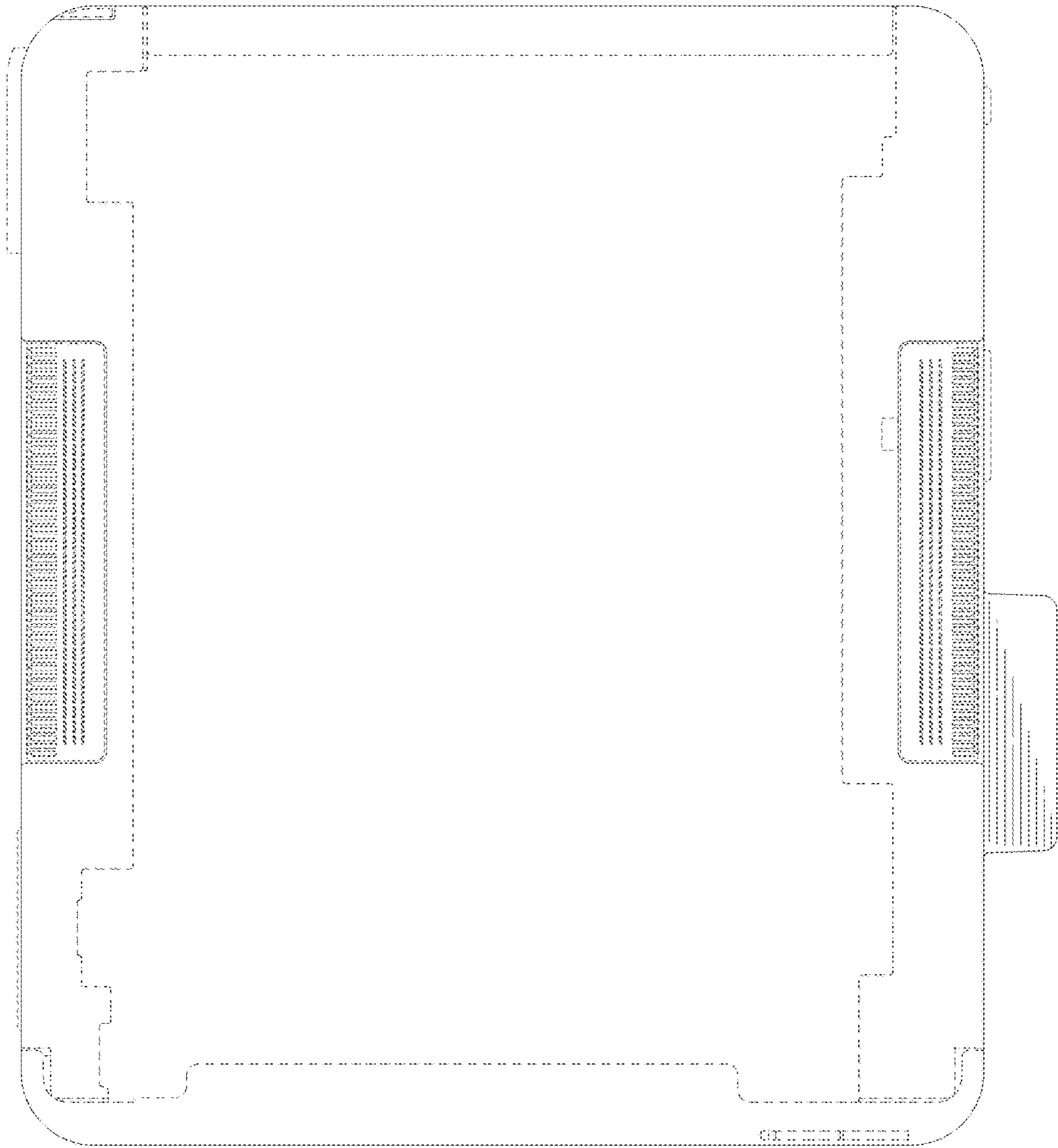

FIG. 7