



US00D805569S

(12) **United States Design Patent** (10) **Patent No.:** **US D805,569 S**
Daugela (45) **Date of Patent:** **** Dec. 19, 2017**

(54) **SQUARE IMAGING APERTURE**
(71) Applicant: **Spectrum Optix Inc.**, Calgary, Alberta (CA)
(72) Inventor: **John Daugela**, Calgary (CA)
(73) Assignee: **SPECTRUM OPTIX INC.**, Calgary (CA)
(**) Term: **15 Years**

D622,750 S * 8/2010 Funakoshi D16/219
D628,611 S * 12/2010 Lewis D16/203
D641,389 S * 7/2011 Dastagir D16/219
(Continued)

(21) Appl. No.: **29/558,095**
(22) Filed: **Mar. 15, 2016**
(51) **LOC (10) Cl.** **16-01**
(52) **U.S. Cl.**
USPC **D16/200**
(58) **Field of Classification Search**
USPC D16/130, 134, 136, 137, 219, 235, 237,
D16/200, 203, 204; D26/120, 124
CPC G02B 13/08; G02B 3/00; G03B 17/565;
G03B 17/08; G03B 17/02
See application file for complete search history.

FOREIGN PATENT DOCUMENTS

EP 2048522 * 4/2015
JP 53127722 A * 11/1978
JP 5022681 * 1/1993

OTHER PUBLICATIONS

Hooser Collectibles, Blue Tit Great Tit Birds Bent Glass Square Dishes Chance Glass Pilkington Group England, Rubylane.com, [online] Sep. 2015 dated cache copy retrieved Nov. 16, 2016 from Archive.org <URL: <https://web.archive.org/web/201509080>.*

(Continued)

Primary Examiner — Sheryl Lane
Assistant Examiner — Calvin E Vansant
(74) *Attorney, Agent, or Firm* — Lewis Roca Rothgerber Christie LLP

(56) **References Cited**

U.S. PATENT DOCUMENTS

D200,126 S * 1/1965 Drucker D16/200
D312,782 S * 12/1990 Arai D16/200
D313,937 S * 1/1991 Arai D16/200
D321,704 S * 11/1991 Leonard D16/200
D362,259 S * 9/1995 Izumi D16/219
D392,659 S * 3/1998 Takano D16/200
D409,641 S * 5/1999 Uehara D16/202
D426,564 S * 6/2000 Rose D16/130
D463,473 S * 9/2002 Miyashita D16/219
D470,520 S * 2/2003 Yamakawa D16/203
D489,746 S * 5/2004 Ogura D16/202
D500,779 S * 1/2005 Shimobayashi D16/202
D504,904 S * 5/2005 Nagai D16/203
D538,318 S * 3/2007 Sprague D16/130
D586,837 S * 2/2009 McCoin D16/203
D607,914 S * 1/2010 Kaplan H04N 5/2252
D14/435.1

(57) **CLAIM**

The ornamental design for square imaging aperture, as shown and described.

DESCRIPTION

FIG. 1 is a front perspective view of the square imaging aperture;
FIG. 2 is a top view thereof;
FIG. 3 is a front view thereof;
FIG. 4 is a bottom view thereof;
FIG. 5 is a left side view thereof;
FIG. 6 is right side view thereof; and,
FIG. 7 is a rear view thereof.
The broken lines depict environmental subject only and form no part of the claim.

1 Claim, 3 Drawing Sheets

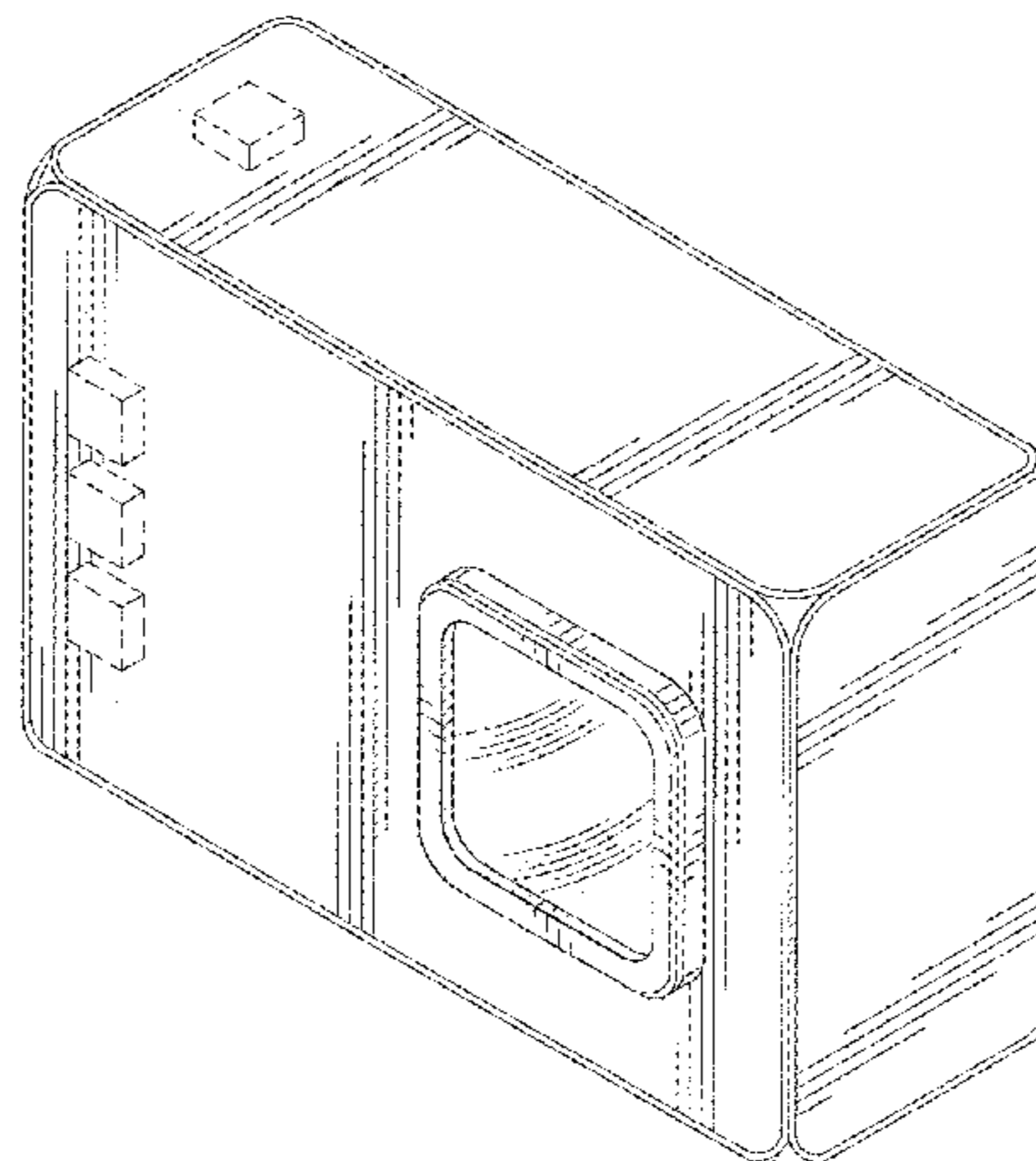

(56)

References Cited

U.S. PATENT DOCUMENTS

D647,554 S * 10/2011 Yim D16/204
 D666,660 S * 9/2012 Amit D16/203
 D702,747 S * 4/2014 Woodman D16/200
 D710,921 S * 8/2014 Gioscia D16/200
 D710,922 S * 8/2014 Gioscia D16/200
 8,870,475 B1 * 10/2014 Bennett G03B 17/561
 396/419
 D725,169 S * 3/2015 Gioscia D16/200
 D727,387 S * 4/2015 Hasegawa D16/203
 9,004,783 B1 * 4/2015 Woodman F16M 11/00
 396/419
 D733,787 S * 7/2015 Baker D16/237
 D733,788 S * 7/2015 Baker D16/237
 D737,879 S * 9/2015 Woodman D16/218
 D739,451 S * 9/2015 Gioscia D16/200
 D740,868 S * 10/2015 Gioscia D16/200
 D741,394 S * 10/2015 Gioscia D16/200
 D750,146 S * 2/2016 Costa D16/200
 D769,346 S * 10/2016 Nguyen D16/218
 D785,695 S * 5/2017 Woodman D16/219
 2003/0035052 A1 * 2/2003 Baron H04N 5/232
 348/207.99

2006/0039149 A1 * 2/2006 Jamnia F21V 29/004
 362/257
 2006/0233545 A1 * 10/2006 Senba G03B 17/14
 396/529
 2007/0267584 A1 * 11/2007 Cherry G02B 13/08
 250/555
 2008/0088941 A1 * 4/2008 Jiang H04N 5/72
 359/668
 2014/0105589 A1 * 4/2014 Samuels F16F 7/00
 396/421
 2015/0064699 A1 * 3/2015 Wietzorrek C12Q 1/686
 435/6.11
 2015/0177608 A1 * 6/2015 Nelson G03B 21/56
 359/449

OTHER PUBLICATIONS

O'donnell, R., Stock Photo of Old Box Camera, undated,
 Dreamstime.com, [online], Retrieved Feb. 28, 2017 from
 URL:<https://www.dreamstime.com/stock-photo-old-box-camera-image627360>>.*

* cited by examiner

FIG. 1

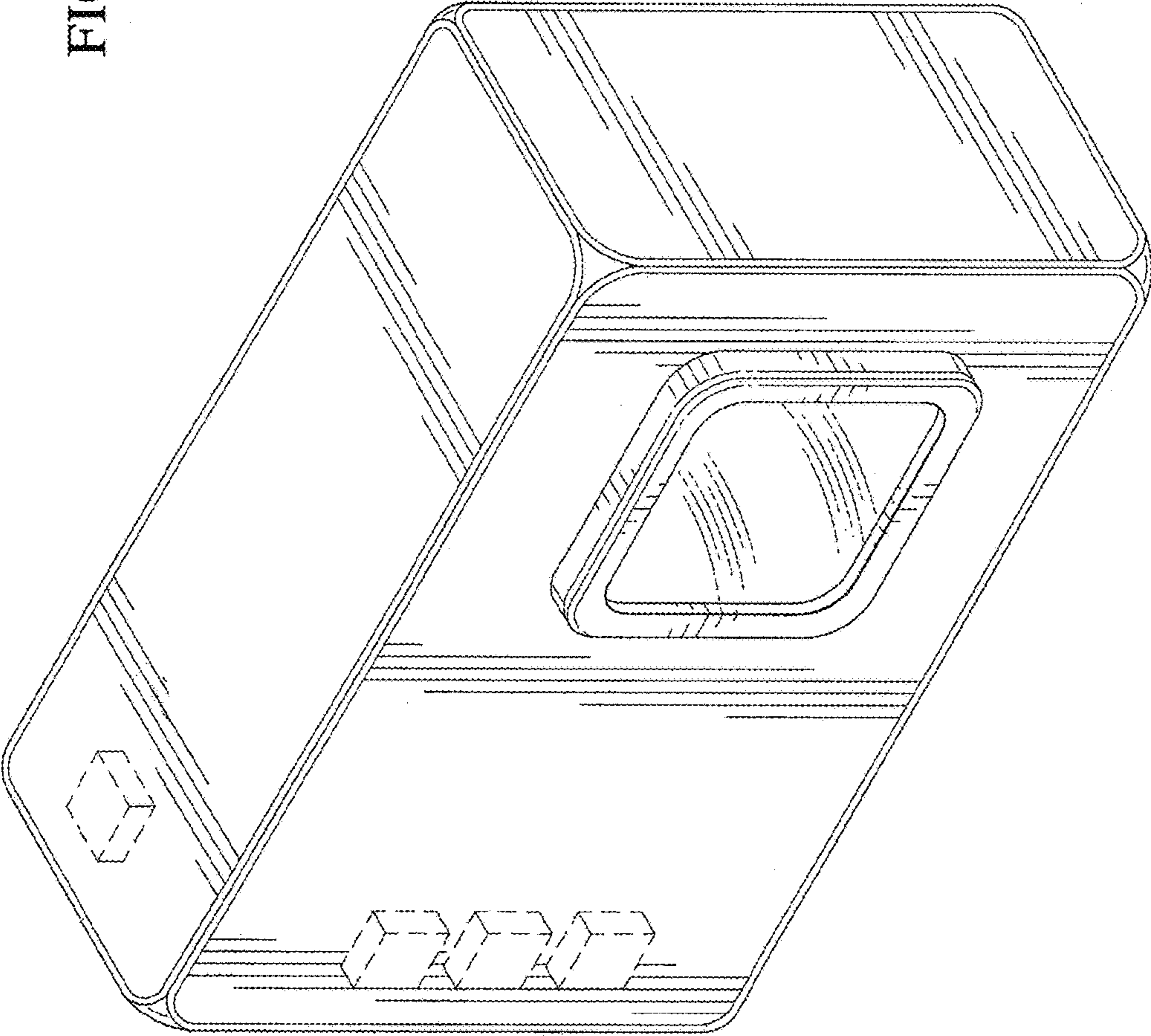

FIG. 2

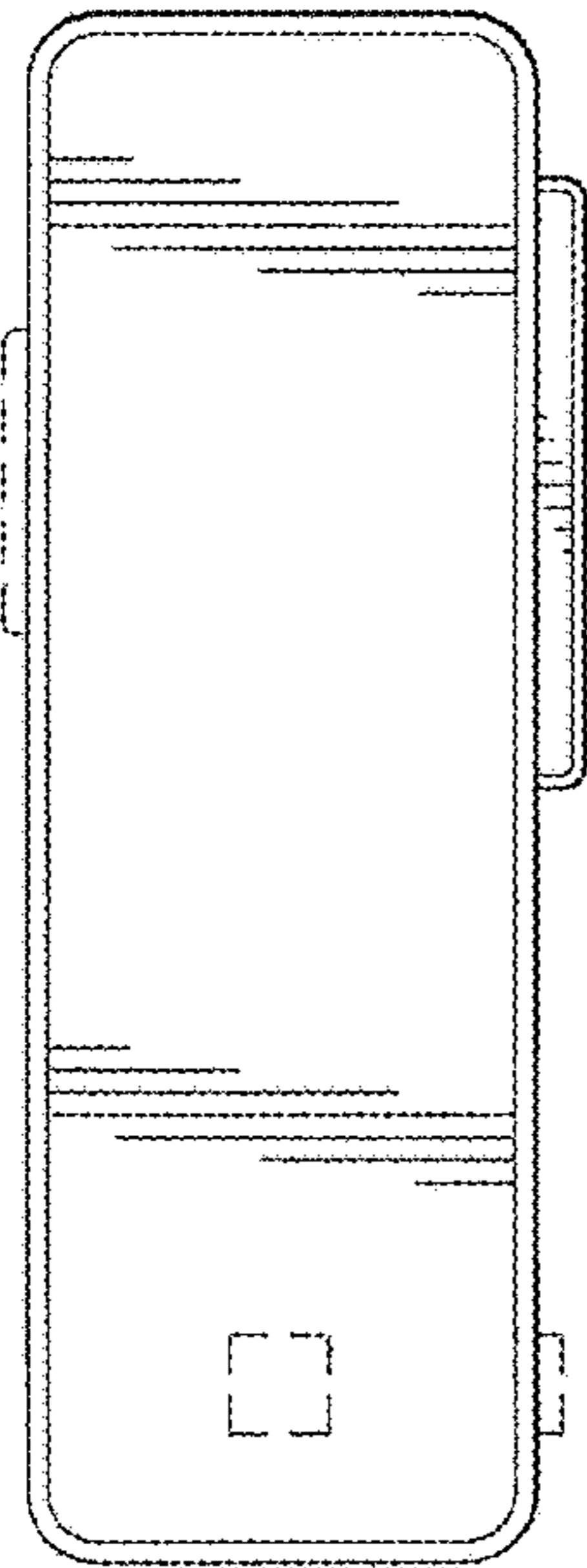

FIG. 3

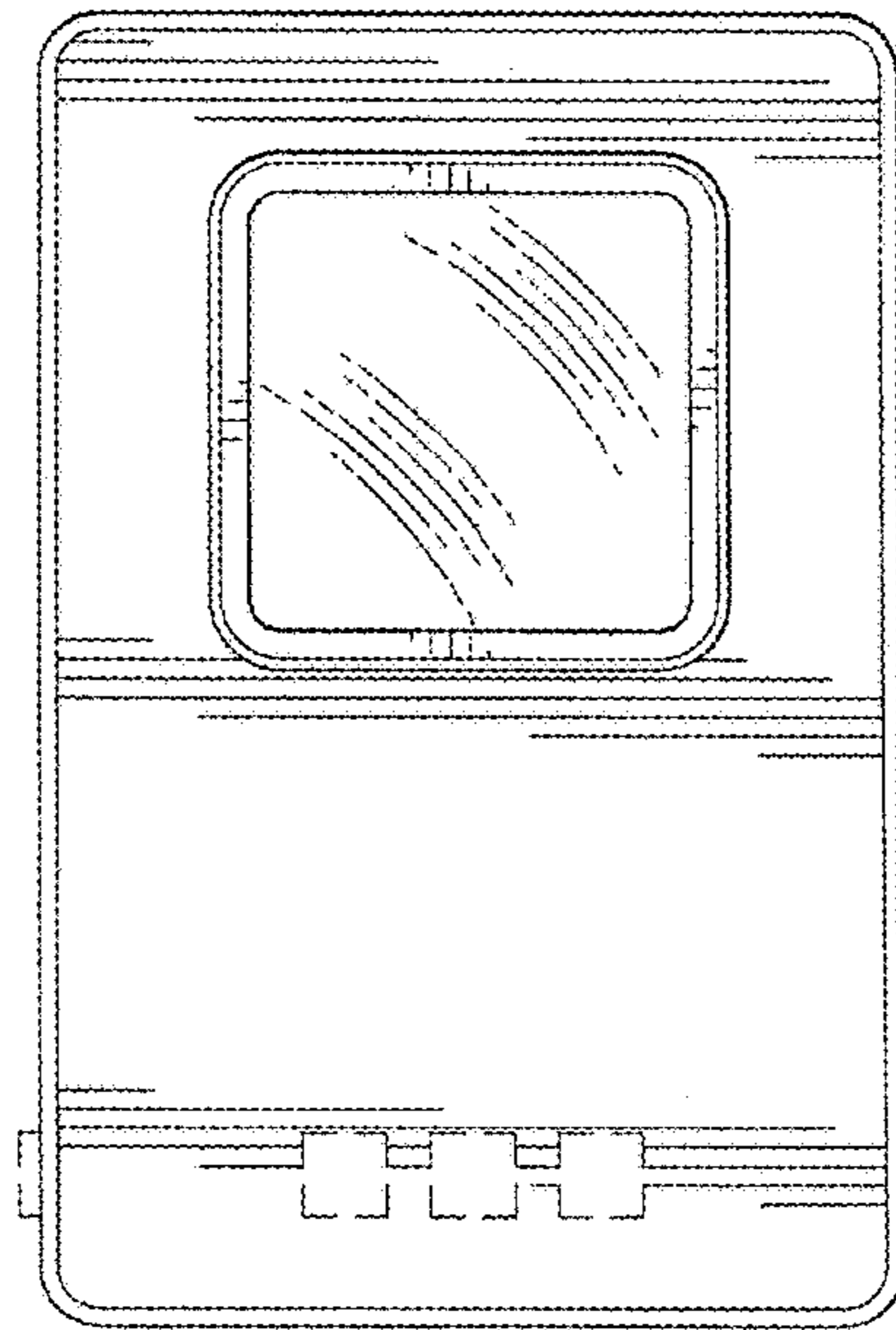

FIG. 5

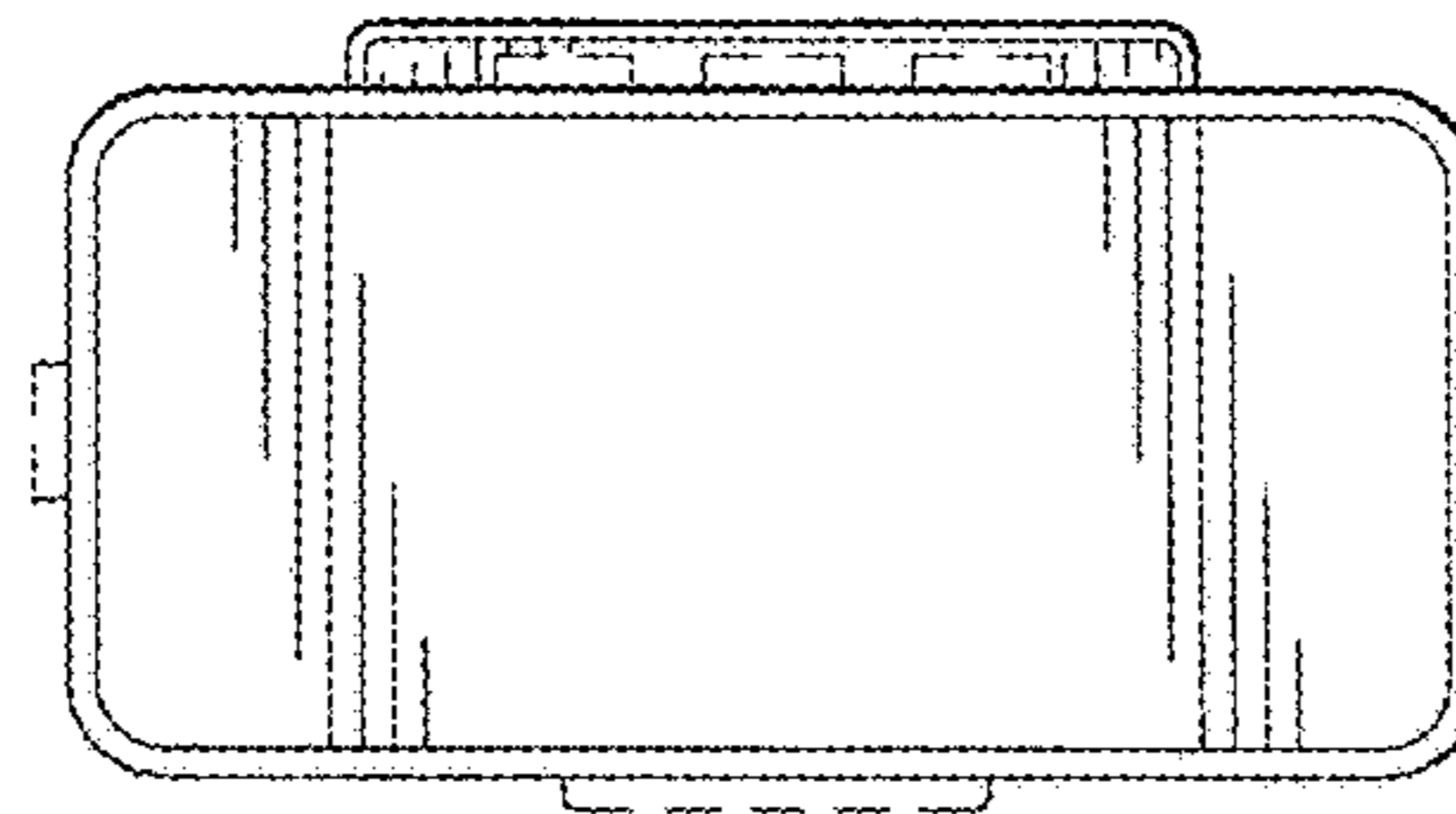

FIG. 6

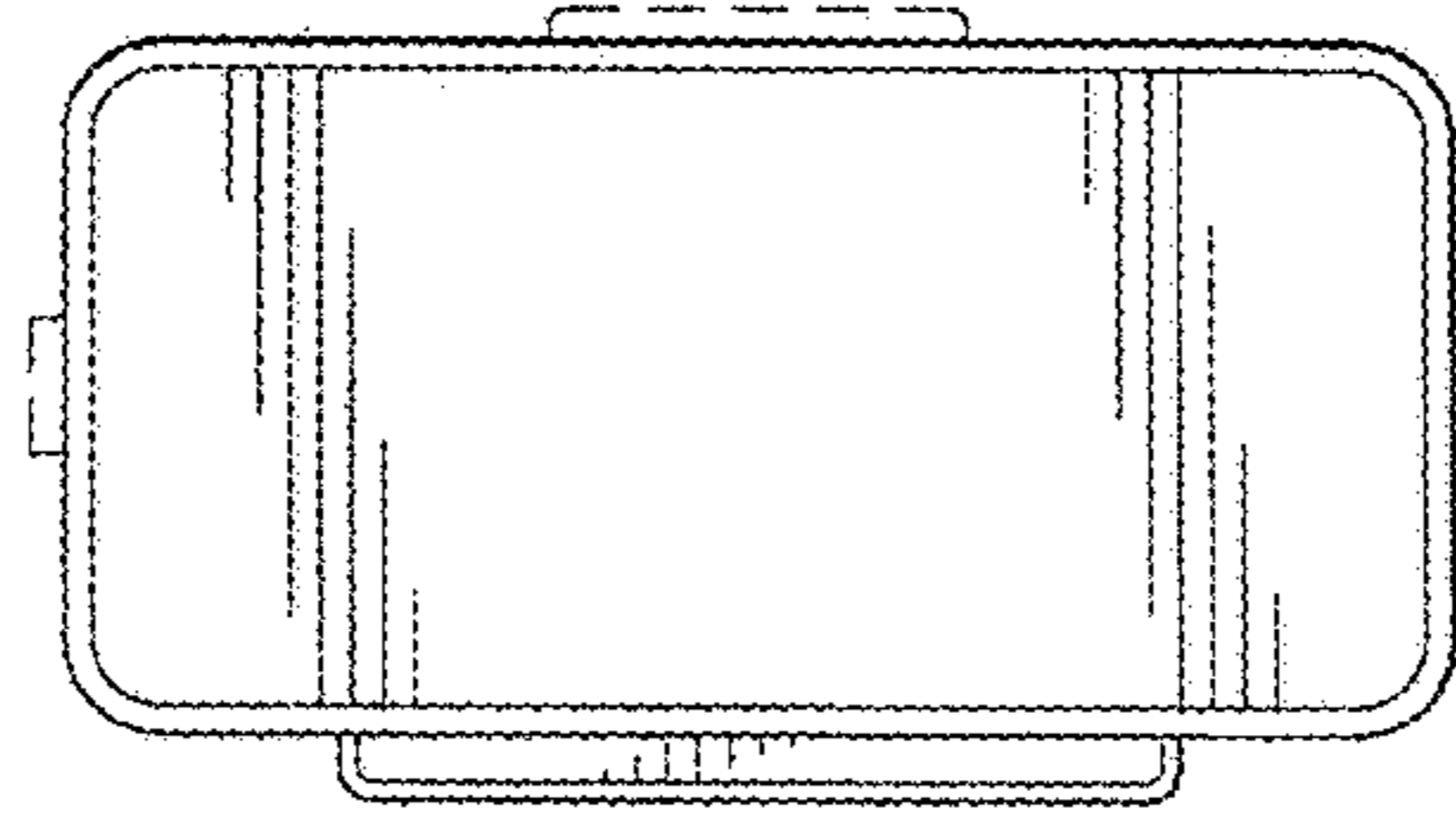

FIG. 4

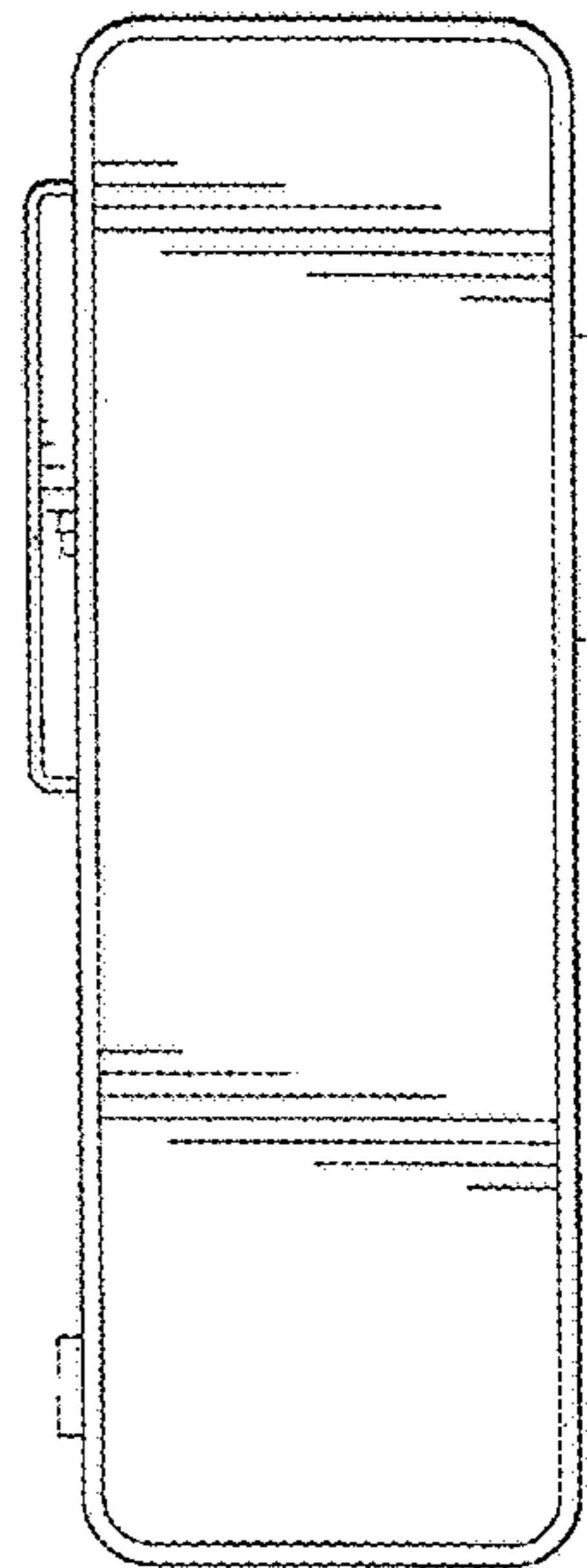

FIG. 7

