



US00D805509S

(12) **United States Design Patent**  
**Hua**

(10) **Patent No.:** **US D805,509 S**

(45) **Date of Patent:** **\*\* Dec. 19, 2017**

(54) **CODE LOCK (WITH RING)**

(71) Applicant: **Jin Hua**, Yuyao (CN)

(72) Inventor: **Jin Hua**, Yuyao (CN)

(\*\*) Term: **15 Years**

(21) Appl. No.: **29/582,028**

(22) Filed: **Oct. 25, 2016**

(51) **LOC (10) Cl.** ..... **08-07**

(52) **U.S. Cl.**  
USPC ..... **D14/334**

(58) **Field of Classification Search**  
USPC ..... D8/300-302, 350, 330, 331, 343, 346,  
D8/334; 70/14, 158, 160, 452, 448, 466,  
70/20, 21, 38 A, 52  
CPC ..... E05B 1/0007; E05B 9/00; E05B 17/00;  
A45C 5/00; A45C 13/00; A45C 13/002  
See application file for complete search history.

(56) **References Cited**

**U.S. PATENT DOCUMENTS**

- 3,750,431 A \* 8/1973 Atkinson ..... E05B 37/025  
70/21
- 4,325,240 A \* 4/1982 Gable ..... E05B 37/0031  
70/284
- 4,444,029 A \* 4/1984 Remington ..... E05B 37/025  
70/25

- D372,187 S \* 7/1996 Ling ..... D8/334
- 6,877,345 B1 \* 4/2005 Misner ..... E05B 35/105  
70/25
- 7,155,944 B1 \* 1/2007 Lin ..... E05B 37/0031  
70/21
- D548,043 S \* 8/2007 Yang ..... D8/334
- D692,745 S \* 11/2013 Stevens ..... D8/334
- D741,143 S \* 10/2015 Grainger ..... D8/334
- D746,660 S \* 1/2016 Stevens ..... D8/334
- D781,131 S \* 3/2017 Nguyen ..... D8/334
- D789,174 S \* 6/2017 Lai ..... D8/334
- D790,952 S \* 7/2017 Nguyen ..... D8/334

\* cited by examiner

*Primary Examiner* — Prabhakar G Deshmukh

(57) **CLAIM**

The ornamental design for a code lock (with ring), as shown and described.

**DESCRIPTION**

FIG. 1 is a front elevational view of a code lock (with ring) showing my new design;  
 FIG. 2 is a rear elevational view thereof;  
 FIG. 3 is a left side view thereof;  
 FIG. 4 is a right side view thereof;  
 FIG. 5 is a top plan view thereof;  
 FIG. 6 is a bottom plan view thereof; and,  
 FIG. 7 is a perspective view thereof.  
 The broken lines shown in Figs. form no part of the claimed design.

**1 Claim, 4 Drawing Sheets**

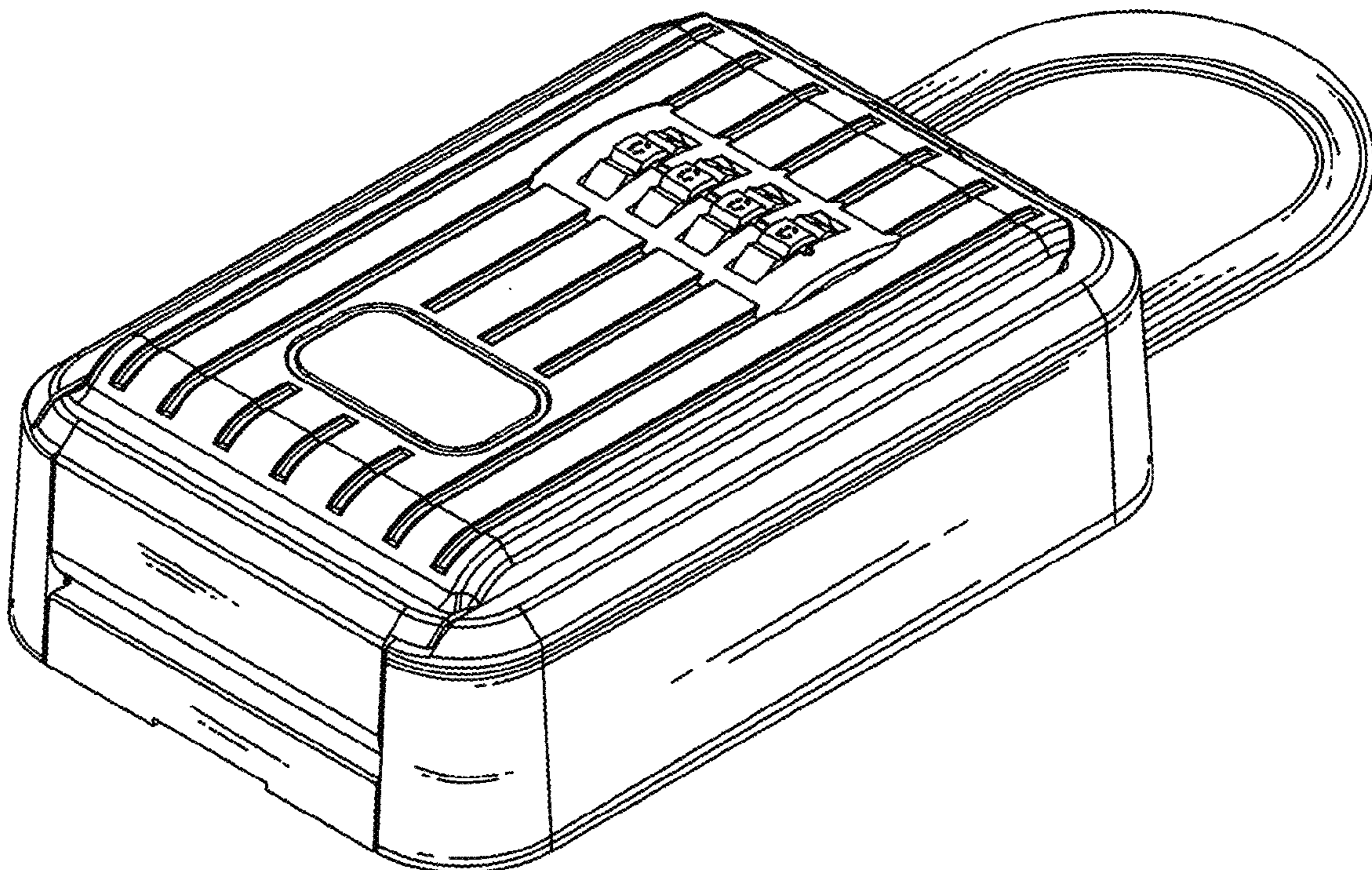

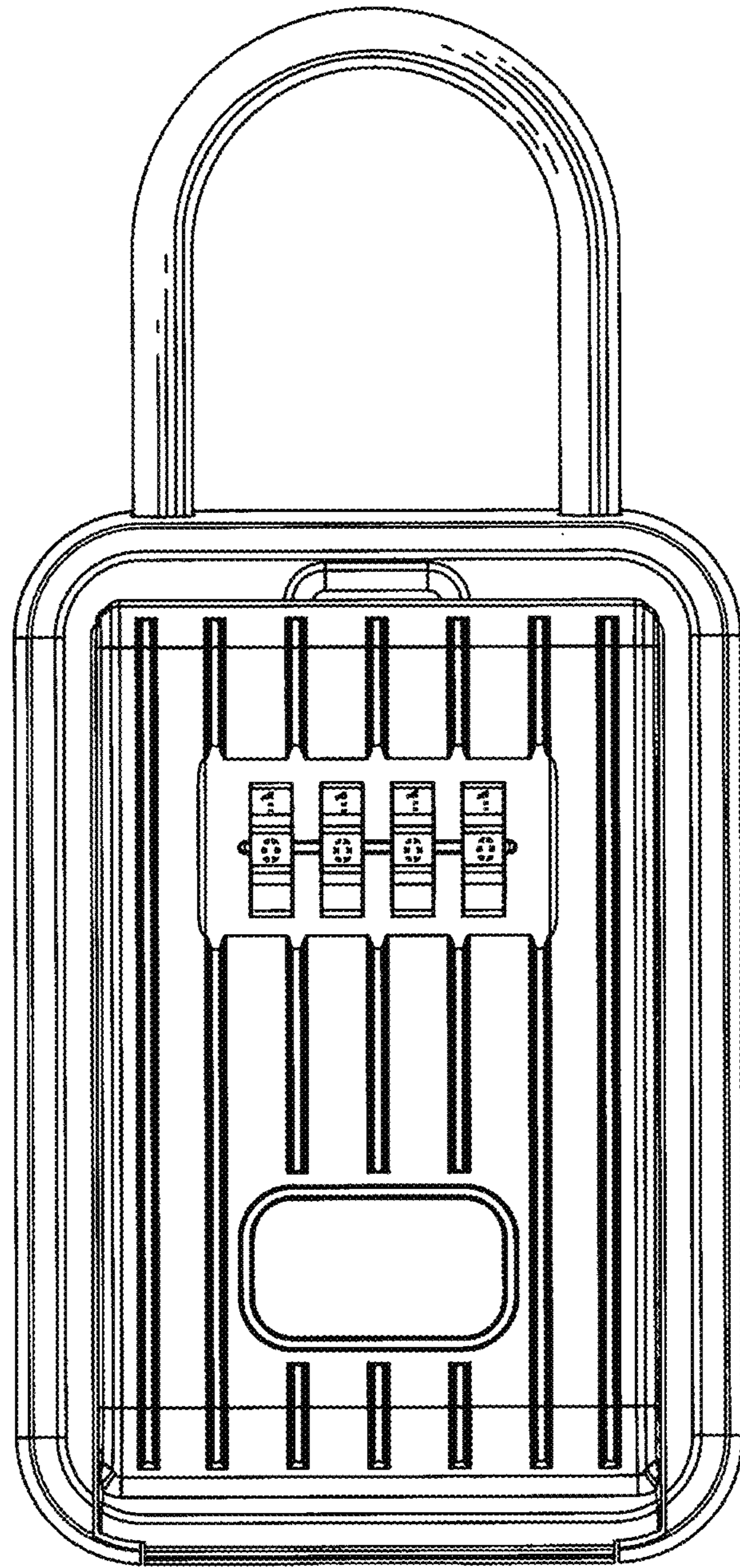

FIG. 1

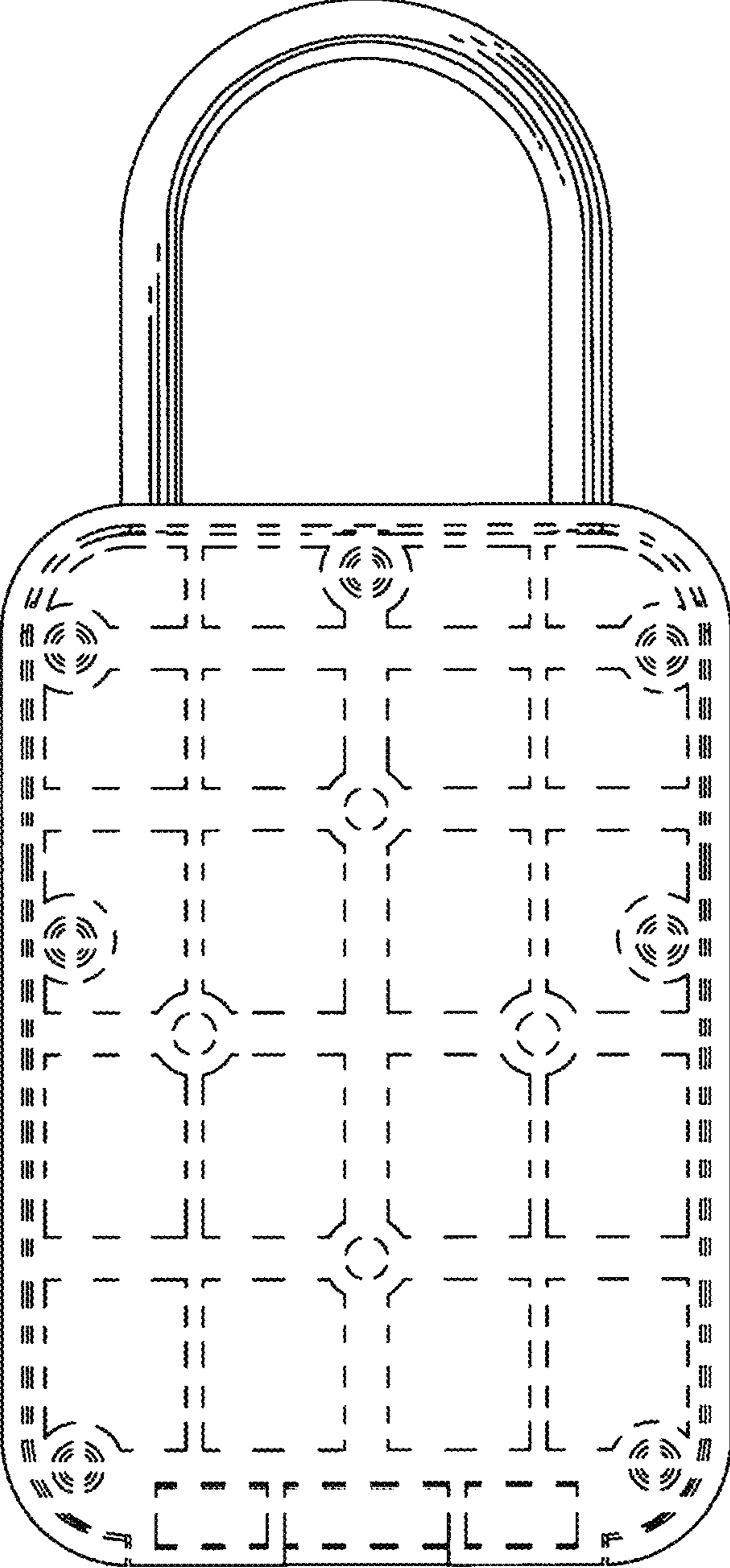

FIG. 2

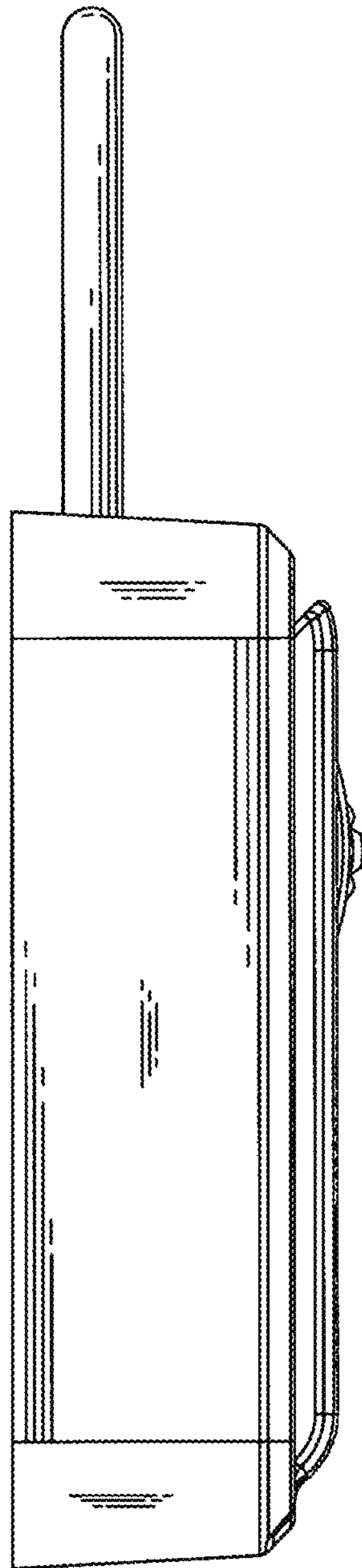

FIG. 3

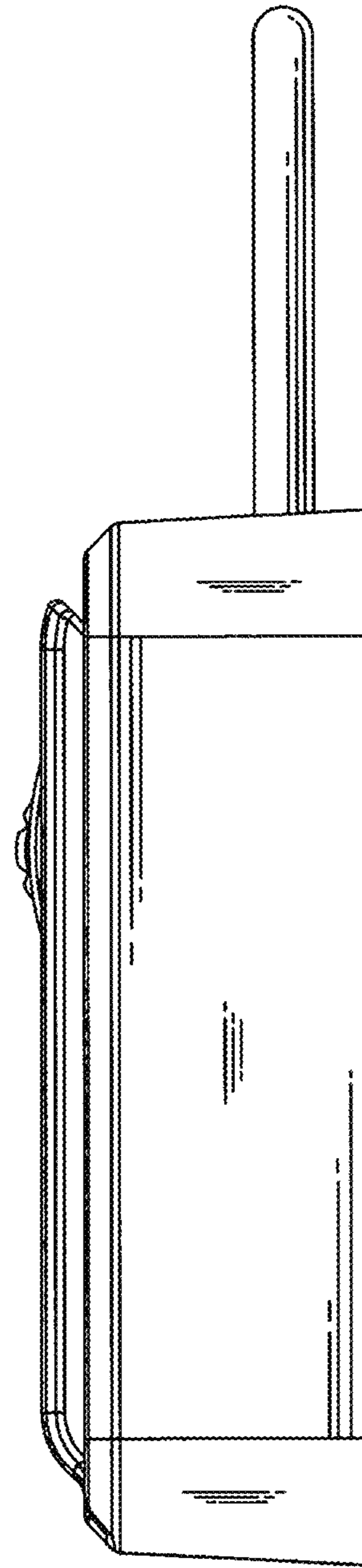

FIG. 4

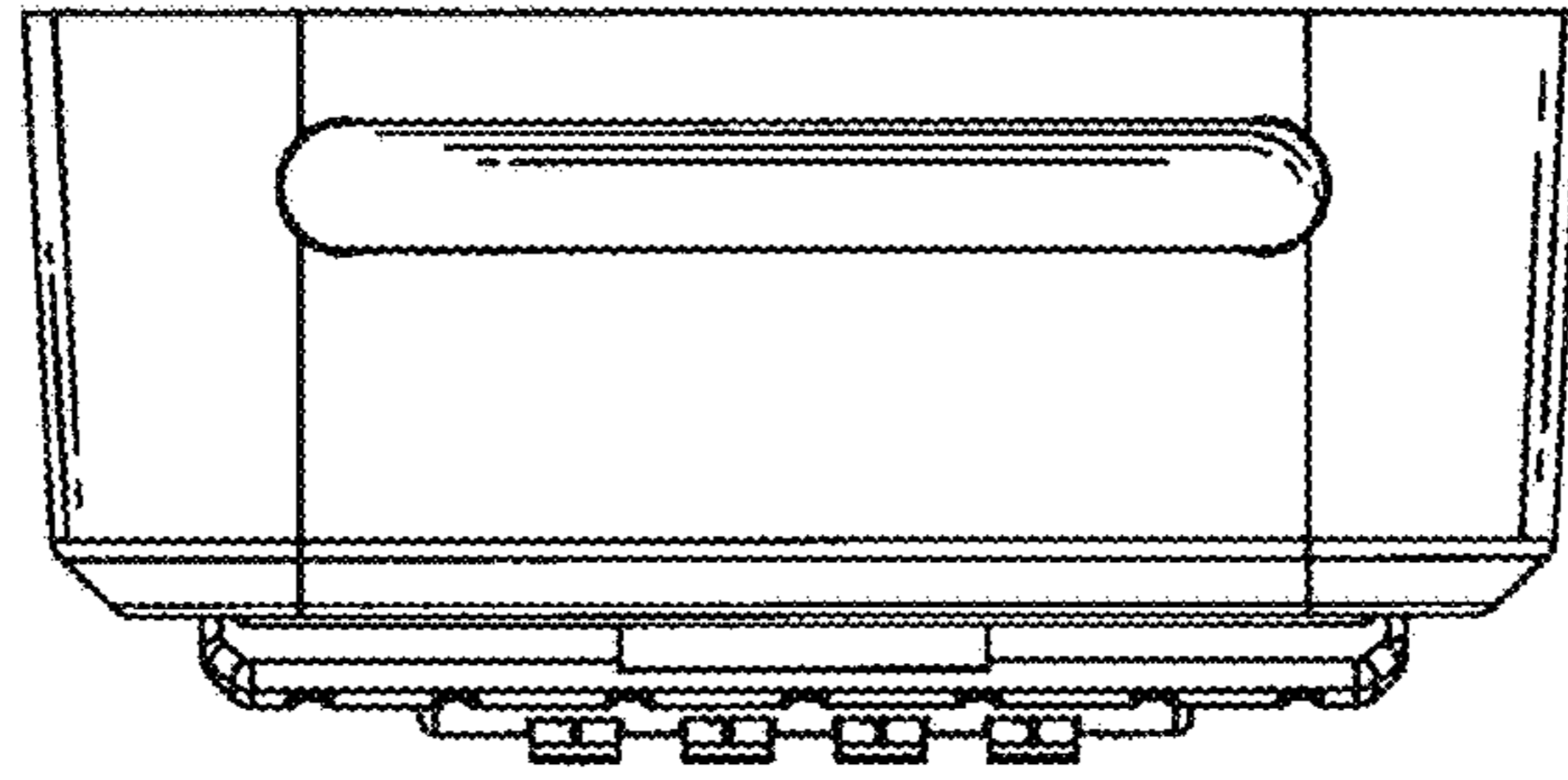

FIG. 5

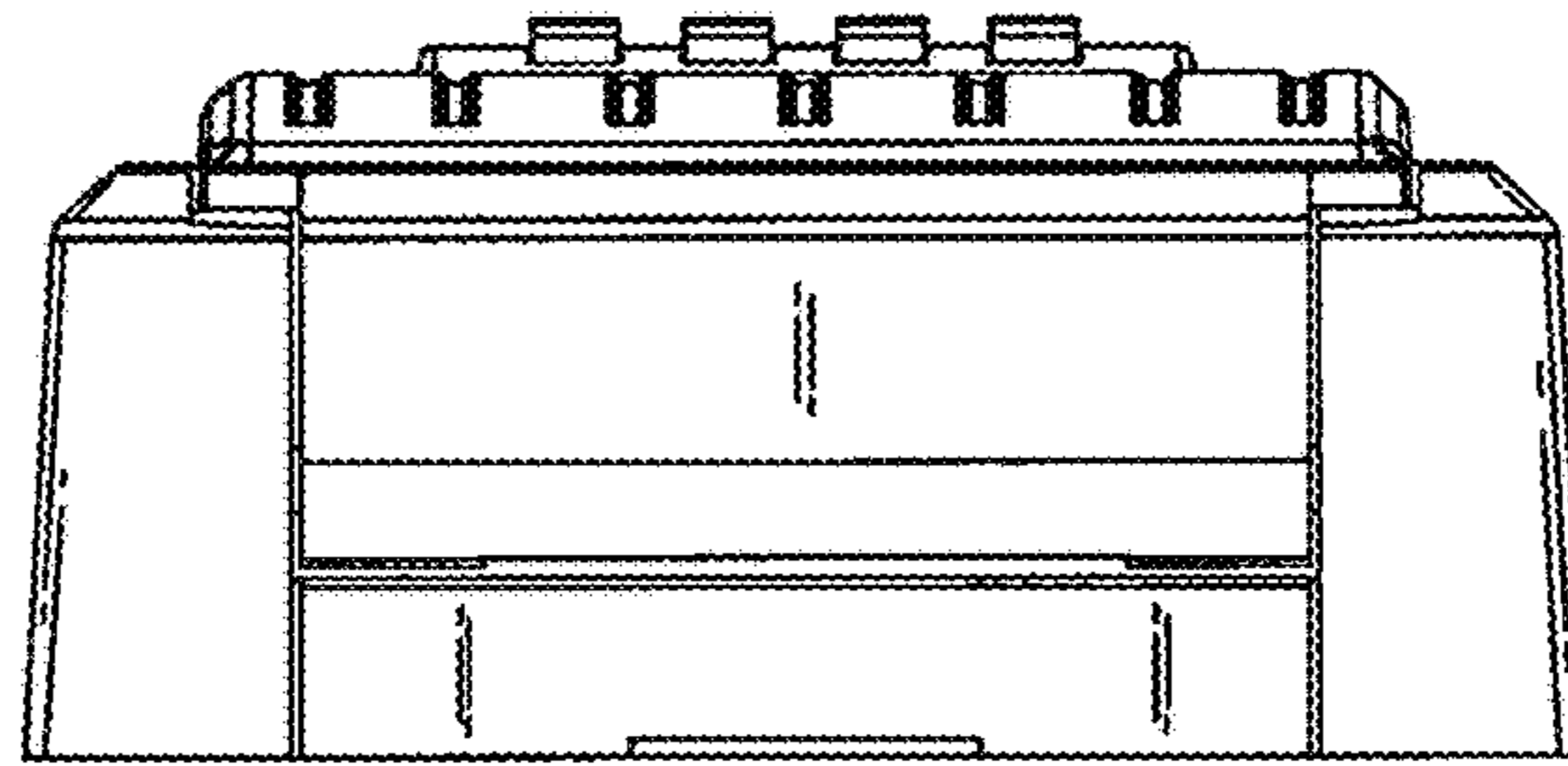

FIG. 6

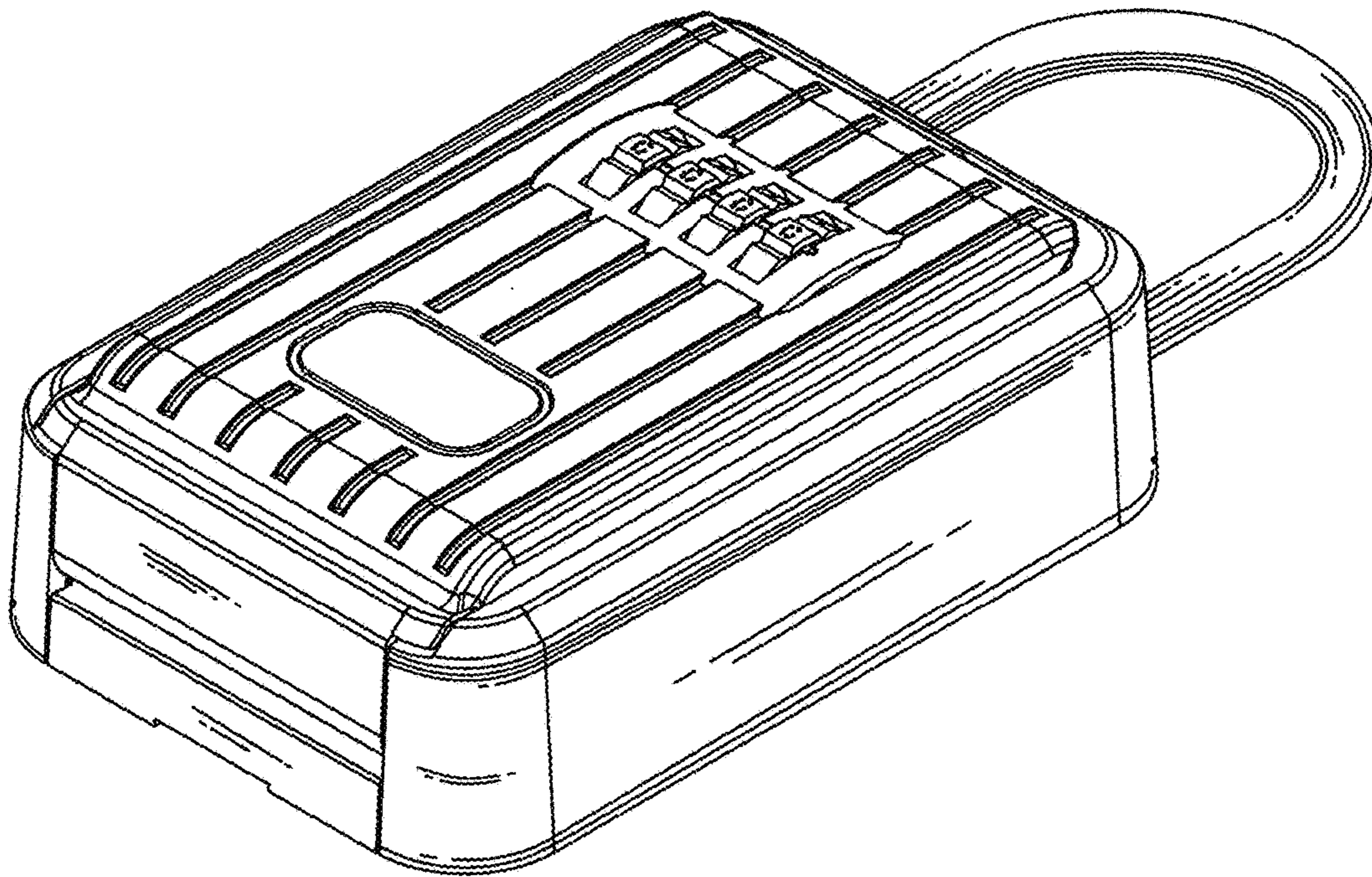

FIG. 7