



US00D805452S

(12) **United States Design Patent** (10) **Patent No.:** **US D805,452 S**  
**Alesi et al.** (45) **Date of Patent:** **\*\* Dec. 19, 2017**

(54) **VEHICLE FLOOR MAT**

FOREIGN PATENT DOCUMENTS

(71) Applicant: **Custom Accessories, Inc.**, Richmond, IL (US)

DE 20013554 U1 3/2001  
EP 1302364 A1 4/2003

(72) Inventors: **Vincent Alesi**, Kildeer, IL (US);  
**Anthony Ferenzi**, Plainfield, IL (US)

OTHER PUBLICATIONS

(73) Assignee: **CUSTOM ACCESSORIES, INC.**,  
Richmond, IL (US)

Armor All Floor Shield™, All Season Protection, 4-Piece, Traps  
Dirt, Snow & Water, Trim to Fit Any Vehicle, Carpet Claw™  
Technology; on sale as early as Mar. 15, 2016.

(\*\*) Term: **15 Years**

(Continued)

(21) Appl. No.: **29/604,705**

*Primary Examiner* — George D. Kirschbaum

(22) Filed: **May 19, 2017**

*Assistant Examiner* — Clese Moore, Jr.

(74) *Attorney, Agent, or Firm* — Patzik, Frank &  
Samotny Ltd.

**Related U.S. Application Data**

(63) Continuation of application No. 29/580,191, filed on  
Oct. 6, 2016, now Pat. No. Des. 800,043.

(51) **LOC (10) Cl.** ..... **12-16**

(52) **U.S. Cl.**  
USPC ..... **D12/203**

(58) **Field of Classification Search**  
USPC ..... D12/203, 221; D6/582–586, 592–594  
CPC ..... B60R 13/01; B60N 3/044; B60N 3/04  
See application file for complete search history.

(57) **CLAIM**

The ornamental design for a vehicle floor mat, as shown and  
described.

(56) **References Cited**

**DESCRIPTION**

U.S. PATENT DOCUMENTS

D418,800 S \* 1/2000 Atkin ..... D12/221  
D425,851 S 5/2000 Tucker  
D429,204 S 8/2000 Lu  
6,155,629 A 12/2000 Sherman  
D450,025 S 11/2001 Lu  
D454,321 S \* 3/2002 Lu ..... D12/203  
D454,322 S \* 3/2002 Lu ..... D12/203  
D454,324 S \* 3/2002 Lu ..... D12/203  
D472,511 S \* 4/2003 Lu ..... D12/203  
D489,306 S 5/2004 Kraines  
D514,493 S 2/2006 MacNeil  
D522,428 S 6/2006 MacNeil

FIG. 1 is a front perspective view of the vehicle floor mat of  
the present invention;  
FIG. 2 is a top plan view of the vehicle floor mat of the  
present invention;  
FIG. 3 is a bottom plan view of the vehicle floor mat of the  
present invention;  
FIG. 4 is a front elevation view of the vehicle floor mat of  
the present invention;  
FIG. 5 is a rear elevation view of the vehicle floor mat of the  
present invention;  
FIG. 6 is a left side elevation view of the vehicle floor mat  
of the present invention; and,  
FIG. 7 is a right side elevation view of the vehicle floor mat  
of the present invention.  
The broken lines depict portions of the article that form no  
part of the claimed design.

(Continued)

**1 Claim, 5 Drawing Sheets**

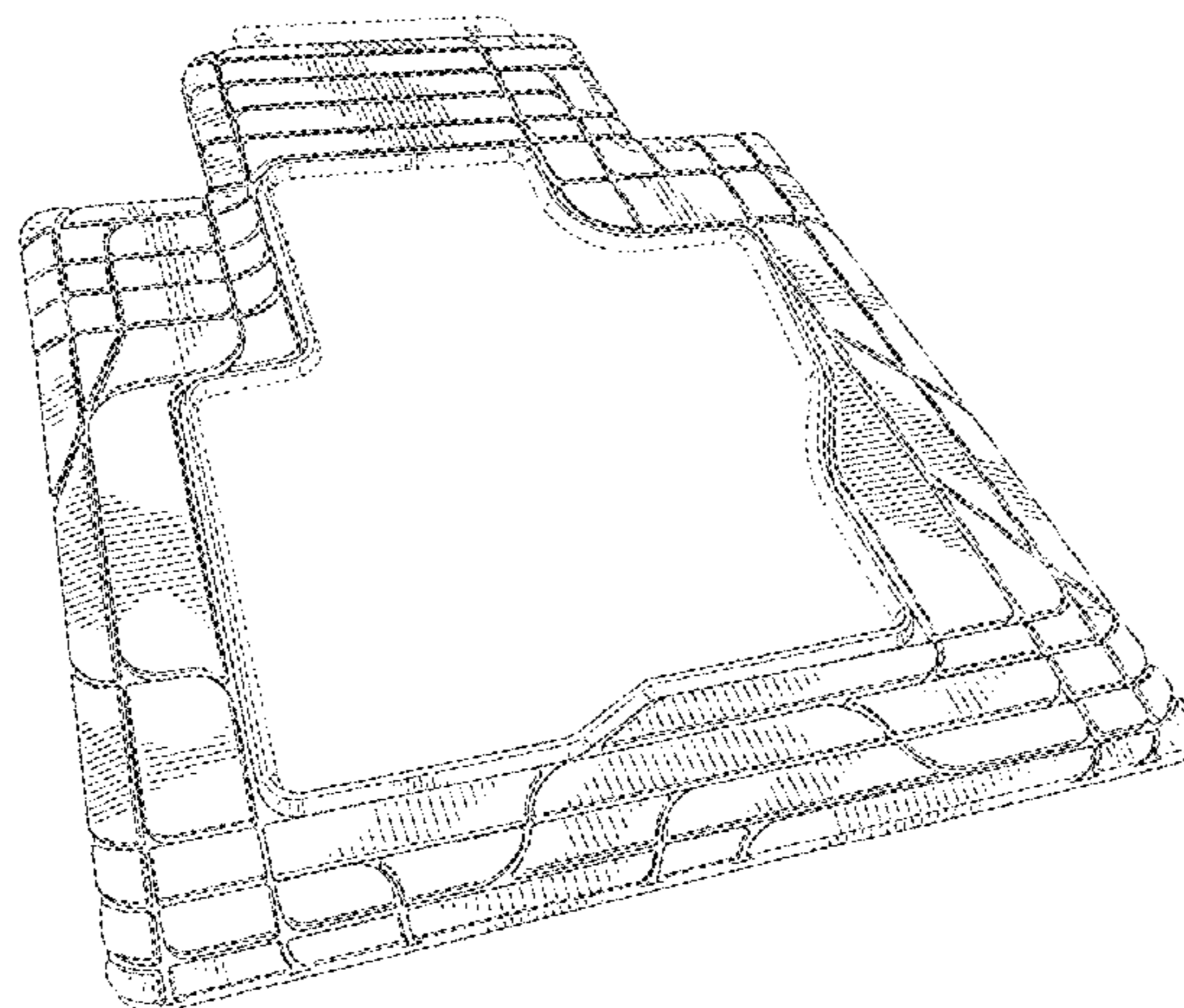

(56)

**References Cited**

U.S. PATENT DOCUMENTS

D530,250	S	10/2006	Thom	
D542,203	S	5/2007	Kraines	
D550,137	S *	9/2007	Kraines .....	D12/203
D569,318	S	5/2008	Kraines	
D608,709	S *	1/2010	Masanek, Jr. ....	D12/203
D647,446	S	10/2011	Jeackjuntra et al.	
D648,253	S *	11/2011	Lu .....	D12/203
8,080,302	B2	12/2011	Gifford et al.	
D656,875	S	4/2012	MacNeil et al.	
D659,623	S	5/2012	Lu	
8,277,918	B1	10/2012	Gifford et al.	
8,455,078	B2	6/2013	Gifford et al.	
D697,856	S *	1/2014	Kingsbury .....	D12/203
D697,857	S *	1/2014	Kingsbury .....	D12/203
D698,718	S *	2/2014	Kingsbury .....	D12/203
8,685,516	B2	4/2014	Gifford et al.	
D777,072	S *	1/2017	Gross .....	D12/203
D777,637	S *	1/2017	Gross .....	D12/203
D793,317	S	8/2017	Alesi et al.	
D793,933	S	8/2017	Alesi et al.	
D793,934	S	8/2017	Alesi et al.	
D793,935	S	8/2017	Alesi et al.	
D793,936	S	8/2017	Alesi et al.	
2013/0022772	A1	1/2013	Gifford et al.	
2013/0171419	A1	7/2013	Tyler et al.	
2014/0212617	A1	7/2014	Gifford et al.	

OTHER PUBLICATIONS

English Translation of European Publication No. EP1302364 (HV Development, SARL), Published Apr. 16, 2003.

English Translation of German Publication No. DE20013554 (APA GmbH & Co KG Otto Bauder), Published Mar. 8, 2001.

Vincent Alesi, et al., co-pending U.S. Appl. No. 29/580,189, filed Oct. 6, 2016, entitled "Vehicle Floor Mat," and having a common inventor and assignee in the present application.

Vincent Alesi, et al, co-pending U.S. Appl. No. 29/580,190, filed Oct. 6, 2016, entitled "Vehicle Floor Mat," and having a common inventor and assignee in the present application.

Vincent Alesi, et al, co-pending U.S. Appl. No. 29/580,191, filed Oct. 6, 2016, entitled "Vehicle Floor Mat," and having a common inventor and assignee in the present application.

Vincent Alesi, et al, co-pending U.S. Appl. No. 29/580,192, filed Oct. 6, 2016, entitled "Vehicle Floor Mat," and having a common inventor and assignee in the present application.

Vincent Alesi, et al, co-pending U.S. Appl. No. 29/580,187, filed Oct. 6, 2016, entitled "Vehicle Floor Mat," and having a common inventor and assignee in the present application.

Vincent Alesi, et al, co-pending U.S. Appl. No. 29/604,702 filed May 19, 2017, entitled "Vehicle Floor Mat," and having a common inventor and assignee in the present application.

Vincent Alesi, et al, co-pending U.S. Appl. No. 29/604,704 filed May 19, 2017, entitled "Vehicle Floor Mat," and having a common inventor and assignee in the present application.

Vincent Alesi, et al, co-pending U.S. Appl. No. 29/604,706 filed May 19, 2017, entitled "Vehicle Floor Mat," and having a common inventor and assignee in the present application.

Vincent Alesi, et al, co-pending U.S. Appl. No. 29/610,540 filed Jul. 13, 2017, entitled "Vehicle Floor Mat," and having a common inventor and assignee in the present application.

\* cited by examiner

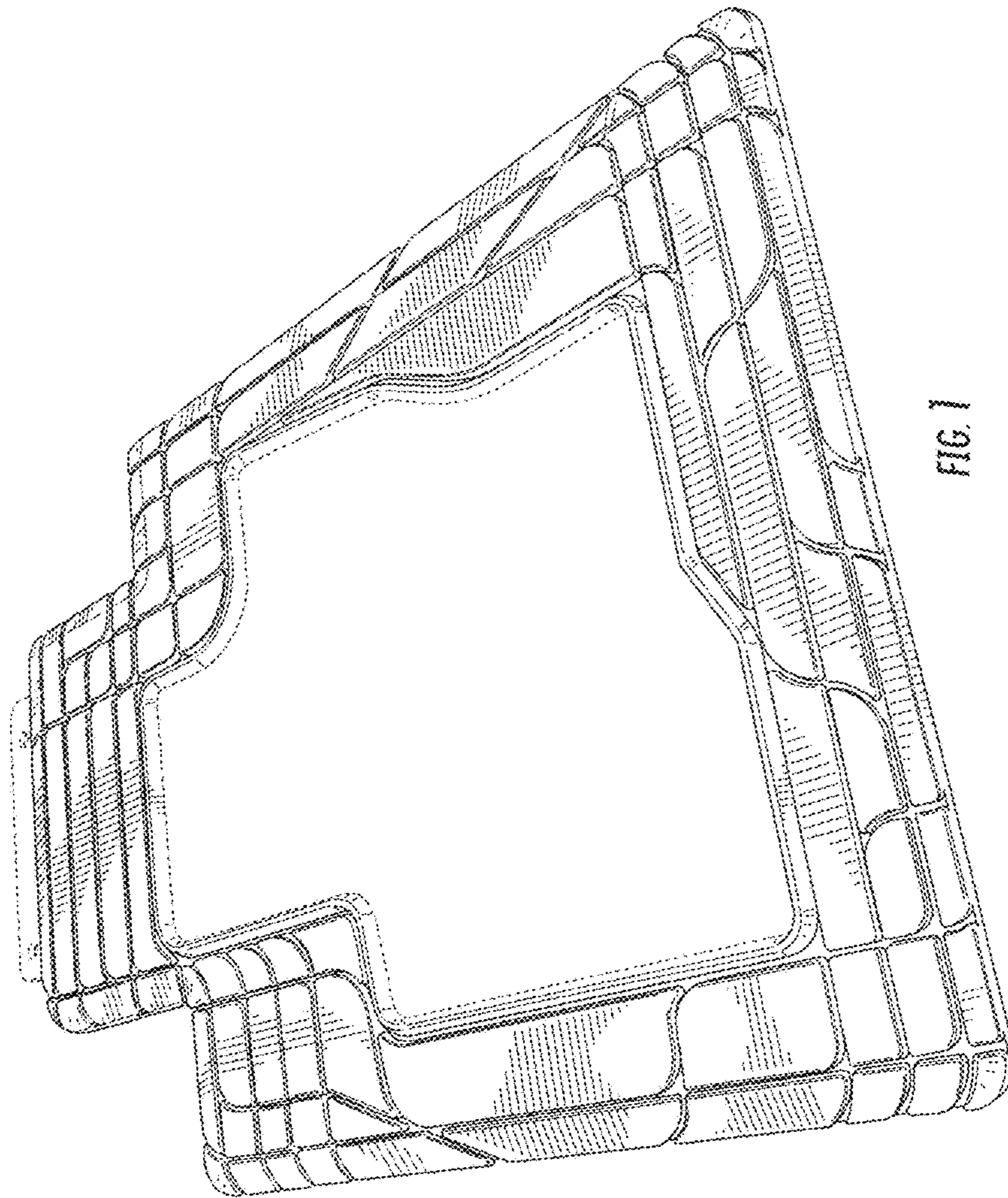

FIG. 1

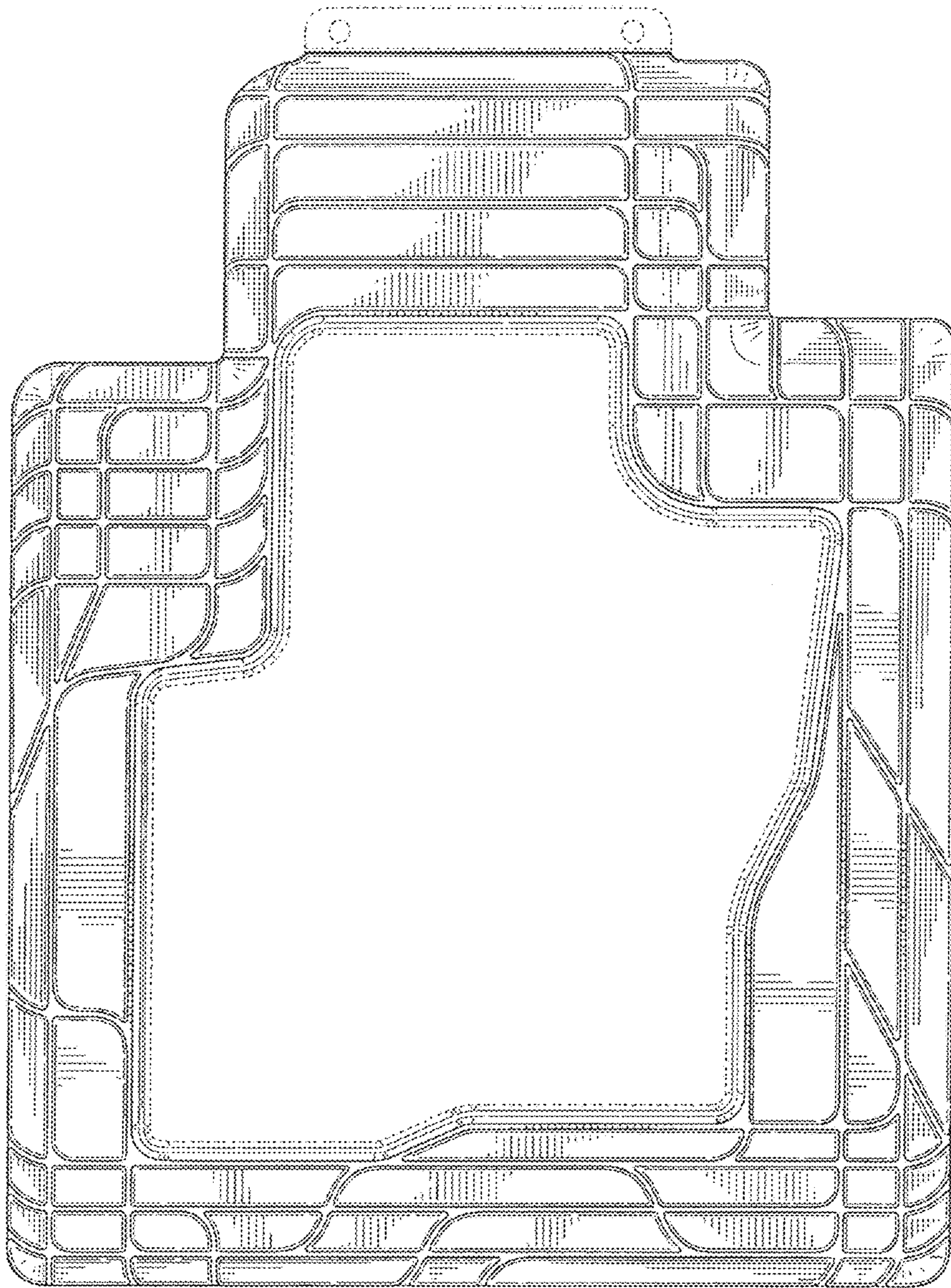

FIG. 2

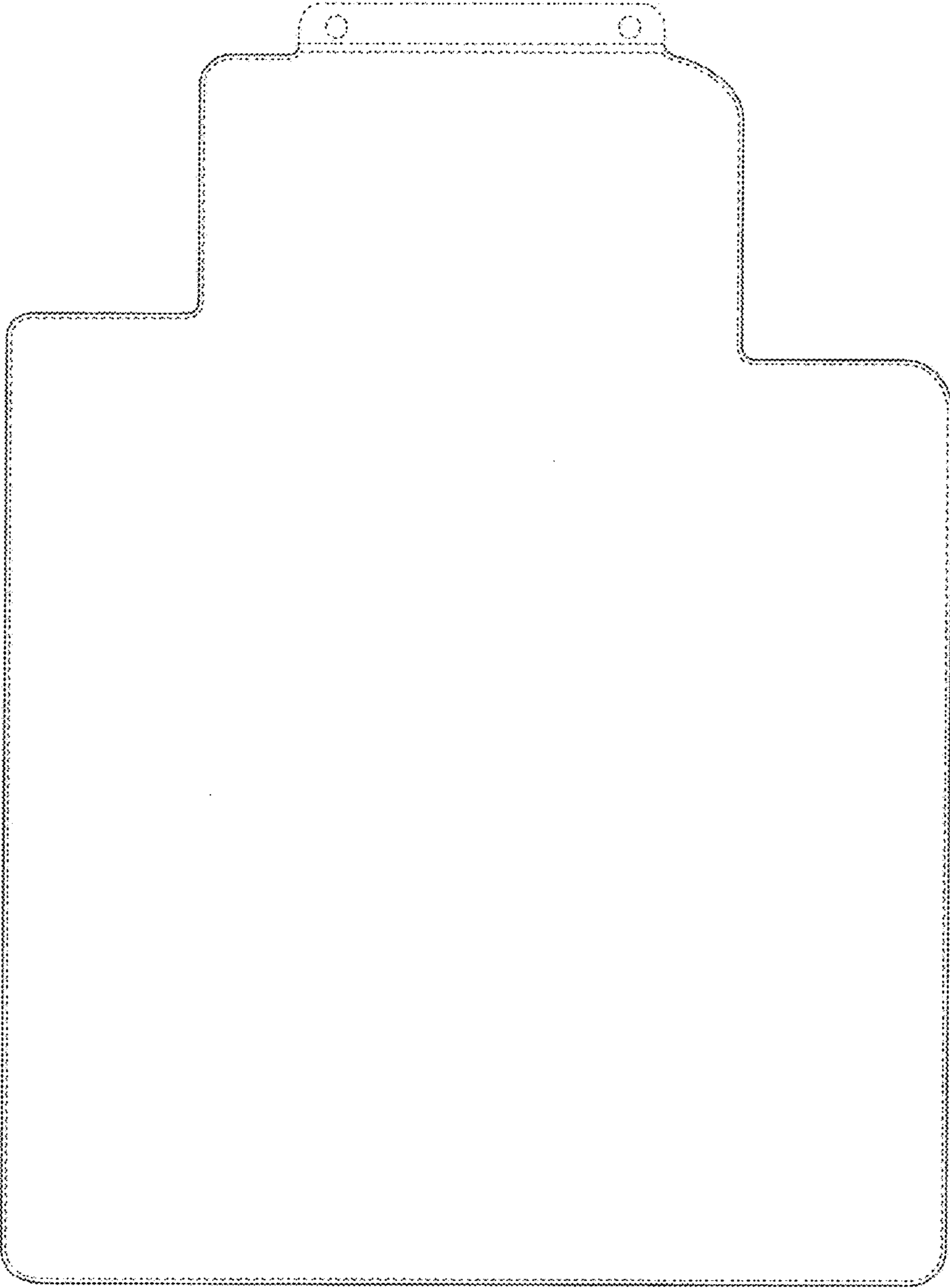

FIG. 3

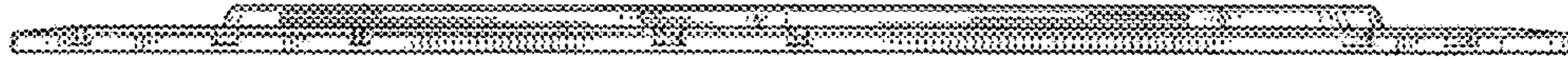

FIG. 4

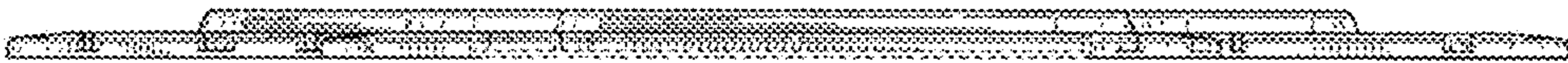

FIG. 5

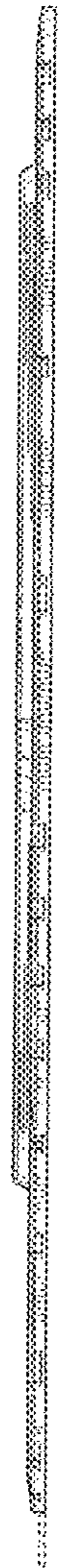

FIG 6



FIG 7