



US00D805450S

(12) **United States Design Patent** (10) **Patent No.:** **US D805,450 S**
Alesi et al. (45) **Date of Patent:** **** Dec. 19, 2017**

(54) **VEHICLE FLOOR MAT**

FOREIGN PATENT DOCUMENTS

(71) Applicant: **Custom Accessories, Inc.**, Richmond, IL (US)

DE 20013554 U1 3/2001
EP 1302364 A1 4/2003

(72) Inventors: **Vincent Alesi**, Kildeer, IL (US);
Anthony Ferenzi, Plainfield, IL (US)

OTHER PUBLICATIONS

(73) Assignee: **CUSTOM ACCESSORIES, INC.**,
Richmond, IL (US)

Armor All Floor Shield™, All Season Protection, 4-Piece, Traps
Dirt, Snow & Water, Trim to Fit Any Vehicle, Carpet Claw™
Technology; on sale as early as Mar. 15, 2016.

(**) Term: **15 Years**

(Continued)

(21) Appl. No.: **29/604,702**

Primary Examiner — George D. Kirschbaum

(22) Filed: **May 19, 2017**

Assistant Examiner — Clese Moore, Jr.

(74) *Attorney, Agent, or Firm* — Patzik, Frank &
Samotny Ltd

Related U.S. Application Data

(63) Continuation of application No. 29/580,187, filed on
Oct. 6, 2016, now Pat. No. Des. 800,041.

(51) **LOC (10) Cl.** **12-16**

(52) **U.S. Cl.**
USPC **D12/203**

(58) **Field of Classification Search**
USPC D12/203, 221; D6/582–586, 592–594
CPC B60R 13/01; B60N 3/044; B60N 3/04
See application file for complete search history.

(57) **CLAIM**

The ornamental design for a vehicle floor mat, as shown and
described.

(56) **References Cited**

DESCRIPTION

U.S. PATENT DOCUMENTS

D418,800 S * 1/2000 Atkin D12/221
D425,851 S 5/2000 Tucker
D429,204 S 8/2000 Lu
6,155,629 A 12/2000 Sherman
D450,025 S 11/2001 Lu
D454,321 S * 3/2002 Lu D12/203
D454,322 S * 3/2002 Lu D12/203
D454,324 S * 3/2002 Lu D12/203
D472,511 S * 4/2003 Lu D12/203
D489,306 S 5/2004 Kraines
D514,493 S 2/2006 MacNeil
D522,428 S 6/2006 MacNeil

FIG. 1 is a front perspective view of the vehicle floor mat of
the present invention;
FIG. 2 is a top plan view of the vehicle floor mat of the
present invention;
FIG. 3 is a bottom plan view of the vehicle floor mat of the
present invention;
FIG. 4 is a front elevation view of the vehicle floor mat of
the present invention;
FIG. 5 is a rear elevation view of the vehicle floor mat of the
present invention;
FIG. 6 is a left side elevation view of the vehicle floor mat
of the present invention; and,
FIG. 7 is a right side elevation view of the vehicle floor mat
of the present invention.
The broken lines depict portions of the article that form no
part of the claimed design.

(Continued)

1 Claim, 5 Drawing Sheets

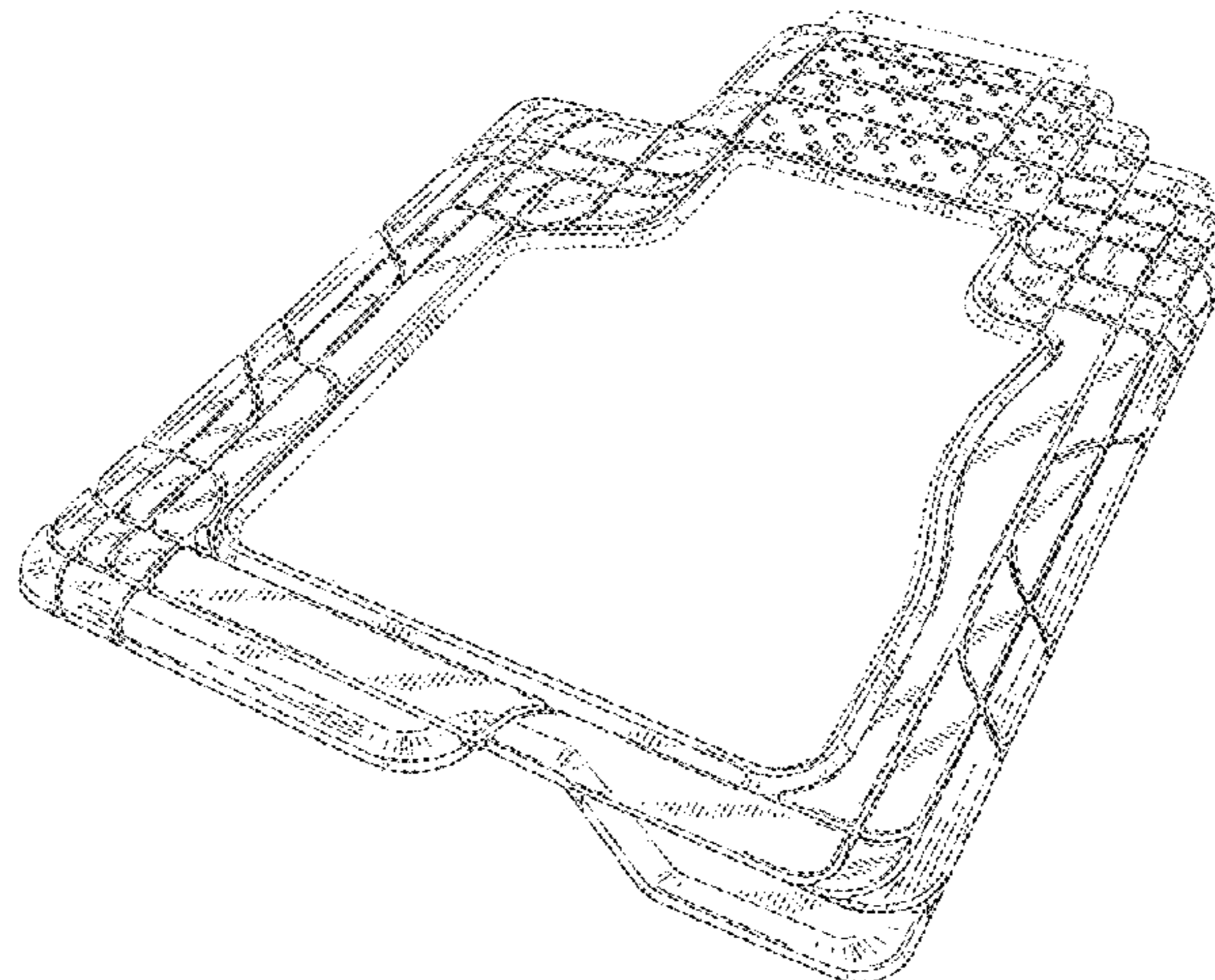

(56)

References Cited

U.S. PATENT DOCUMENTS

D530,250	S	*	10/2006	Thom	D12/203
D542,203	S		5/2007	Kraines		
D550,137	S	*	9/2007	Kraines	D12/203
D569,318	S		5/2008	Kraines		
D608,709	S	*	1/2010	Masanek, Jr.	D12/203
D647,446	S		10/2011	Jeackjuntra et al.		
D648,253	S	*	11/2011	Lu	D12/203
8,080,302	B2		12/2011	Gifford et al.		
D656,875	S		4/2012	MacNeil et al.		
D659,623	S		5/2012	Lu		
8,277,918	B1		10/2012	Gifford et al.		
8,455,078	B2		6/2013	Gifford et al.		
D697,856	S	*	1/2014	Kingsbury	D12/203
D697,857	S	*	1/2014	Kingsbury	D12/203
D698,718	S	*	2/2014	Kingsbury	D12/203
8,685,516	B2		4/2014	Gifford et al.		
D777,072	S	*	1/2017	Gross	D12/203
D777,637	S	*	1/2017	Gross	D12/203
D793,317	S		8/2017	Alesi et al.		
D793,933	S		8/2017	Alesi et al.		
D793,934	S		8/2017	Alesi et al.		
D793,935	S		8/2017	Alesi et al.		
D793,936	S		8/2017	Alesi et al.		
2013/0022772	A1		1/2013	Gifford et al.		
2013/0171419	A1		7/2013	Tyler et al.		
2014/0212617	A1		7/2014	Gifford et al.		

OTHER PUBLICATIONS

English Translation of European Publication No. EP1302364 (HV Development, SARL), Published Apr. 16, 2003.

English Translation of German Publication No. DE20013554 (APA GMBH & CO KG Otto Bauder), Published Mar. 8, 2001.

Vincent Alesi, et al., co-pending U.S. Appl. No. 29/580,189, filed Oct. 6, 2016, entitled "Vehicle Floor Mat," and having a common inventor and assignee in the present application.

Vincent Alesi, et al., co-pending U.S. Appl. No. 29/580,190, filed Oct. 6, 2016, entitled "Vehicle Floor Mat," and having a common inventor and assignee in the present application.

Vincent Alesi, et al., co-pending U.S. Appl. No. 29/580,191, filed Oct. 6, 2016, entitled "Vehicle Floor Mat," and having a common inventor and assignee in the present application.

Vincent Alesi, et al., co-pending U.S. Appl. No. 29/580,192, filed Oct. 6, 2016, entitled "Vehicle Floor Mat," and having a common inventor and assignee in the present application.

Vincent Alesi, et al., co-pending U.S. Appl. No. 29/580,187, filed Oct. 6, 2016, entitled "Vehicle Floor Mat," and having a common inventor and assignee in the present application.

Vincent Alesi, et al., co-pending U.S. Appl. No. 29/604,704, filed May 19, 2017, entitled "Vehicle Floor Mat," and having a common inventor and assignee in the present application.

Vincent Alesi, et al., co-pending U.S. Appl. No. 29/604,705, filed May 19, 2017, entitled "Vehicle Floor Mat," and having a common inventor and assignee in the present application.

Vincent Alesi, et al., co-pending U.S. Appl. No. 29/604,706, filed May 19, 2017, entitled "Vehicle Floor Mat," and having a common inventor and assignee in the present application.

Vincent Alesi, et al., co-pending U.S. Appl. No. 29/610,540, filed Jul. 13, 2017, entitled "Vehicle Floor Mat," and having a common inventor and assignee in the present application.

* cited by examiner

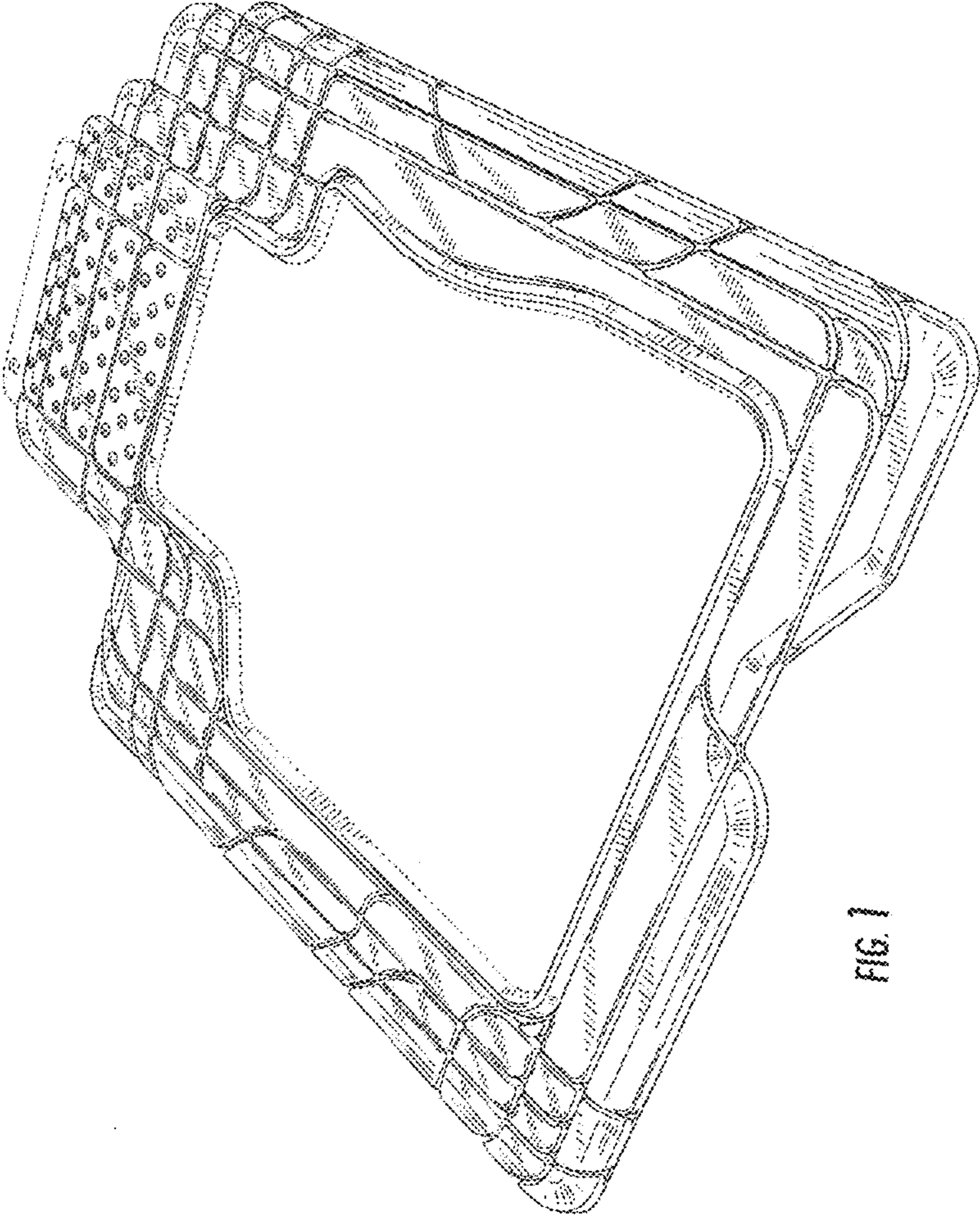

FIG. 1

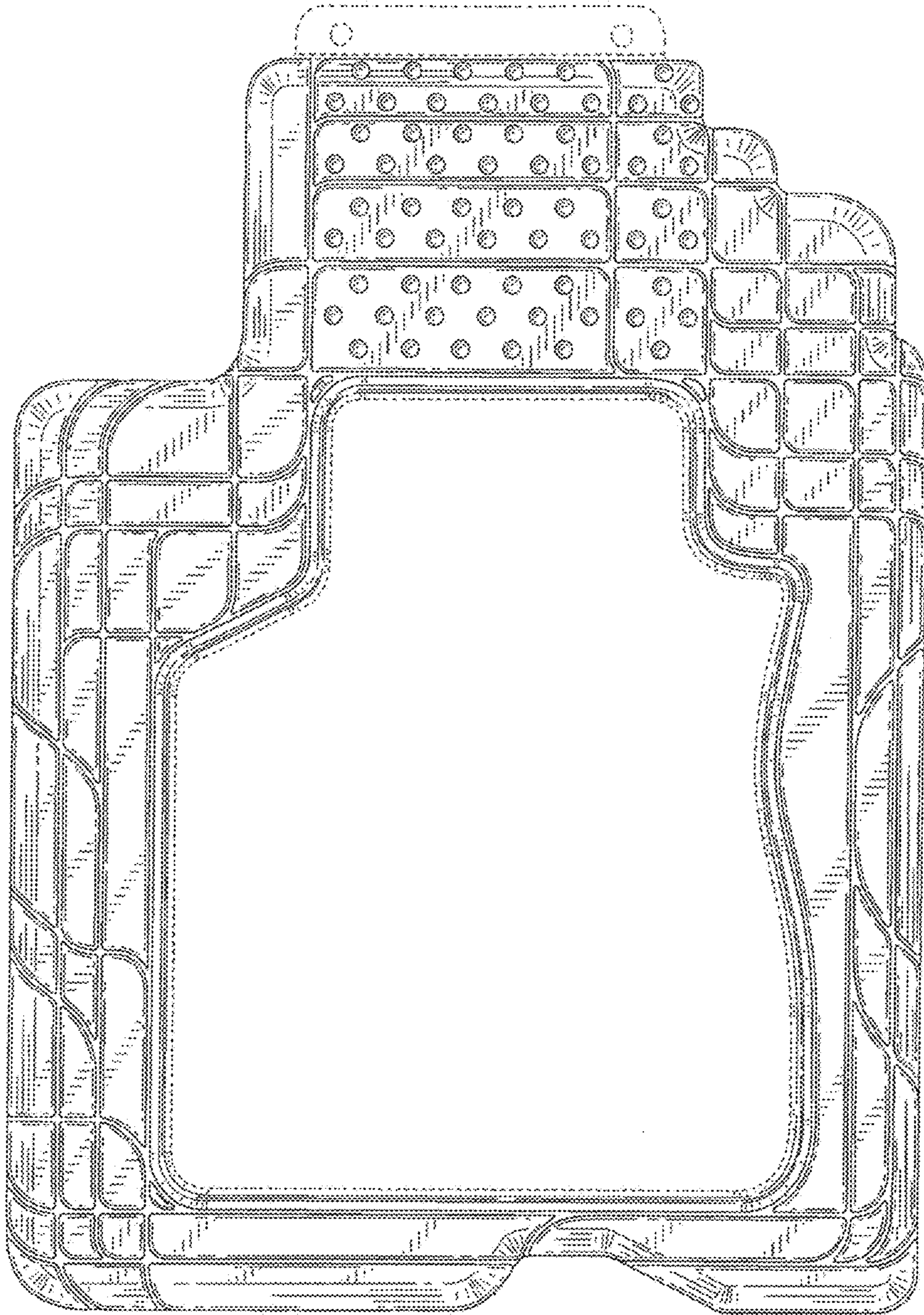

FIG. 2

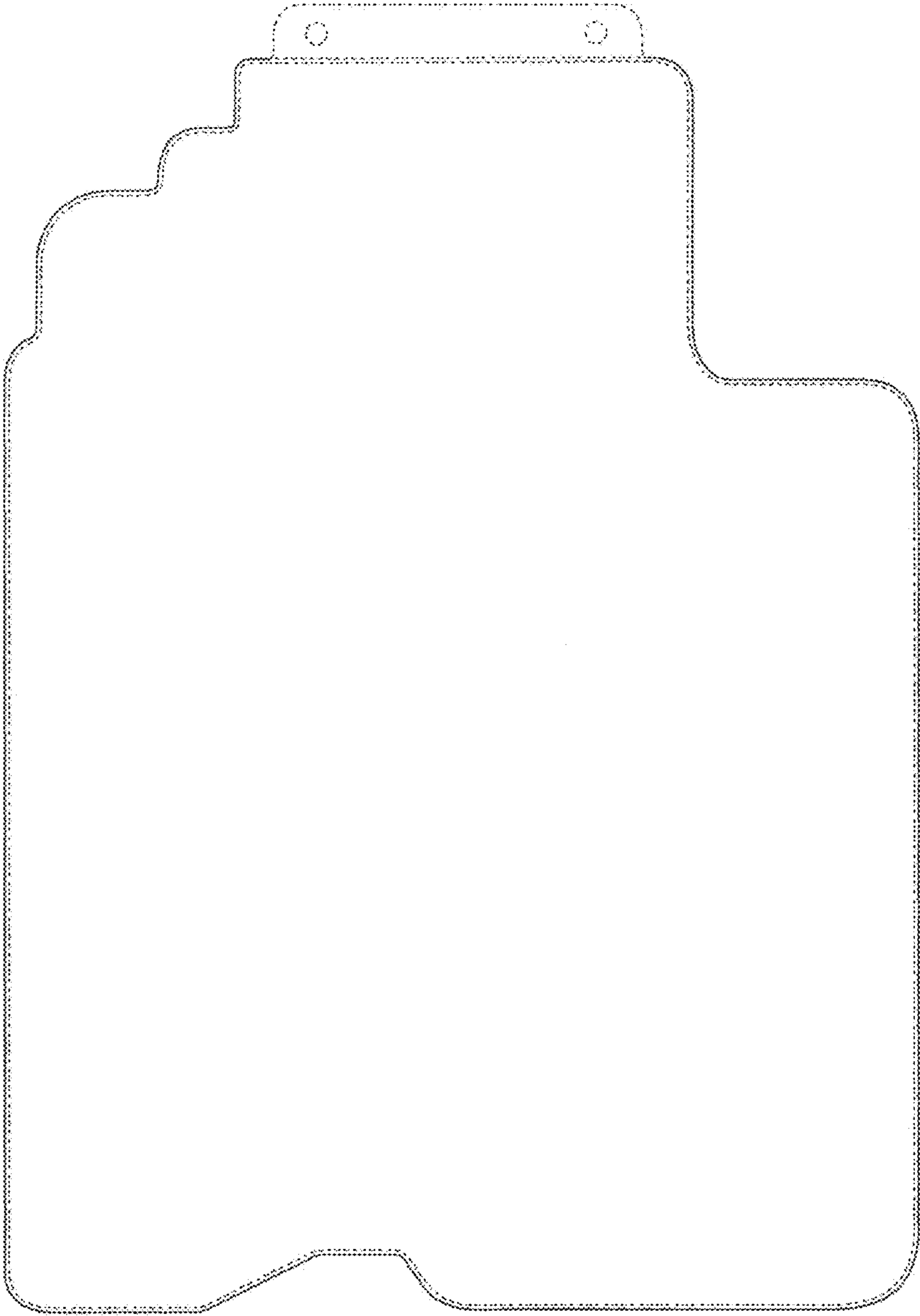

FIG. 3

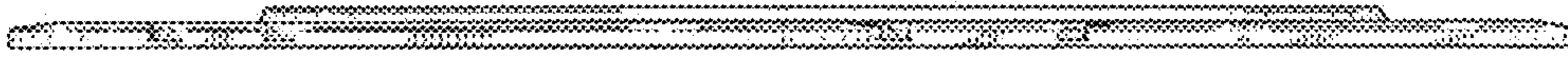

FIG. 4

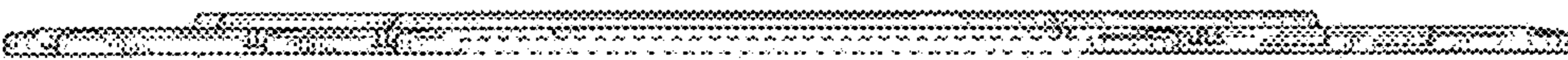

FIG. 5

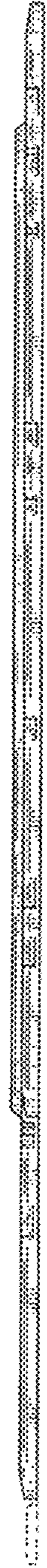

FIG. 6

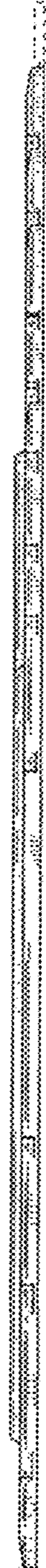

FIG. 7