



US00D805398S

(12) **United States Design Patent** (10) **Patent No.:** **US D805,398 S**  
**Torchin et al.** (45) **Date of Patent:** **\*\* Dec. 19, 2017**

(54) **PACKAGE**

- (71) Applicant: **Under Armour, Inc.**, Baltimore, MD (US)
- (72) Inventors: **Evan Torchin**, Baltimore, MD (US); **Brian Boring**, Baltimore, MD (US); **Helene Christman**, Baltimore, MD (US); **Paul Pugh**, Baltimore, MD (US); **Eric Boam**, Baltimore, MD (US); **Breyna Fries**, Baltimore, MD (US)
- (73) Assignee: **Under Armour, Inc.**, Baltimore, MD (US)
- (\*\*) Term: **15 Years**

- (21) Appl. No.: **29/571,479**
- (22) Filed: **Jul. 19, 2016**
- (51) **LOC (10) Cl.** ..... **09-03**
- (52) **U.S. Cl.**  
USPC ..... **D9/737**
- (58) **Field of Classification Search**  
USPC ..... D9/414-418, 430-434, 762, 757, 737, D9/761, 420-426, 501, 721, 739, 742,  
(Continued)

(56) **References Cited**

**U.S. PATENT DOCUMENTS**

- D92,782 S \* 7/1934 Tourtois ..... D9/517  
D94,457 S \* 1/1935 Williamson ..... D3/263  
(Continued)

**OTHER PUBLICATIONS**

Under Armour's HealthBox (via DC Rainmaker), available Jan. 5, 2016, [online], [site visited May 14, 2017]. Available from internet, <URL:https://www.dcrainmaker.com/2016/01/under-armour-healthbox.html.\*

(Continued)

*Primary Examiner* — Cathron Brooks  
*Assistant Examiner* — Teddy Falloway  
(74) *Attorney, Agent, or Firm* — Maginot, Moore & Beck LLP

(57) **CLAIM**

The ornamental design for a package, as shown and described.

**DESCRIPTION**

Cross reference is made to copending U.S. design patent application Ser. No. 29/571,480 entitled "Package" by Torchin et al. filed on even date herewith; U.S. design patent application Ser. No. 29/571,481 entitled "Package" by Torchin et al. filed on even date herewith; U.S. design patent application Ser. No. 29/571,482 entitled "Package" by Torchin et al. filed on even date herewith; U.S. design patent application Ser. No. 29/571,483 entitled "Package" by Torchin et al. filed on even date herewith; and U.S. design patent application Ser. No. 29/571,484 entitled "Package" by Torchin et al. filed on even date herewith.

FIG. 1 is a perspective view of a package showing our new design in a partially open configuration;  
FIG. 2 is a front elevational view showing the design for the package of FIG. 1 in the partially open configuration;  
FIG. 3 is a rear elevational view showing the design for the package of FIG. 1 in the partially open configuration;  
FIG. 4 is a right side elevational view showing the design for the package of FIG. 1 in the partially open configuration;  
FIG. 5 is a left side elevational view showing the design for the package of FIG. 1 in the partially open configuration;  
FIG. 6 is a top plan view showing the design for the package of FIG. 1 in the partially open configuration;  
FIG. 7 is a bottom plan view showing the design for the package of FIG. 1 in the partially open configuration;  
FIG. 8 is a perspective view showing the design for the package of FIG. 1 in a closed configuration; and,  
FIG. 9 is a perspective view showing the design for the package of FIG. 1 in an open configuration.  
The broken lines shown in the drawings illustrate portions of the package that form no part of the claimed design.

**1 Claim, 7 Drawing Sheets**

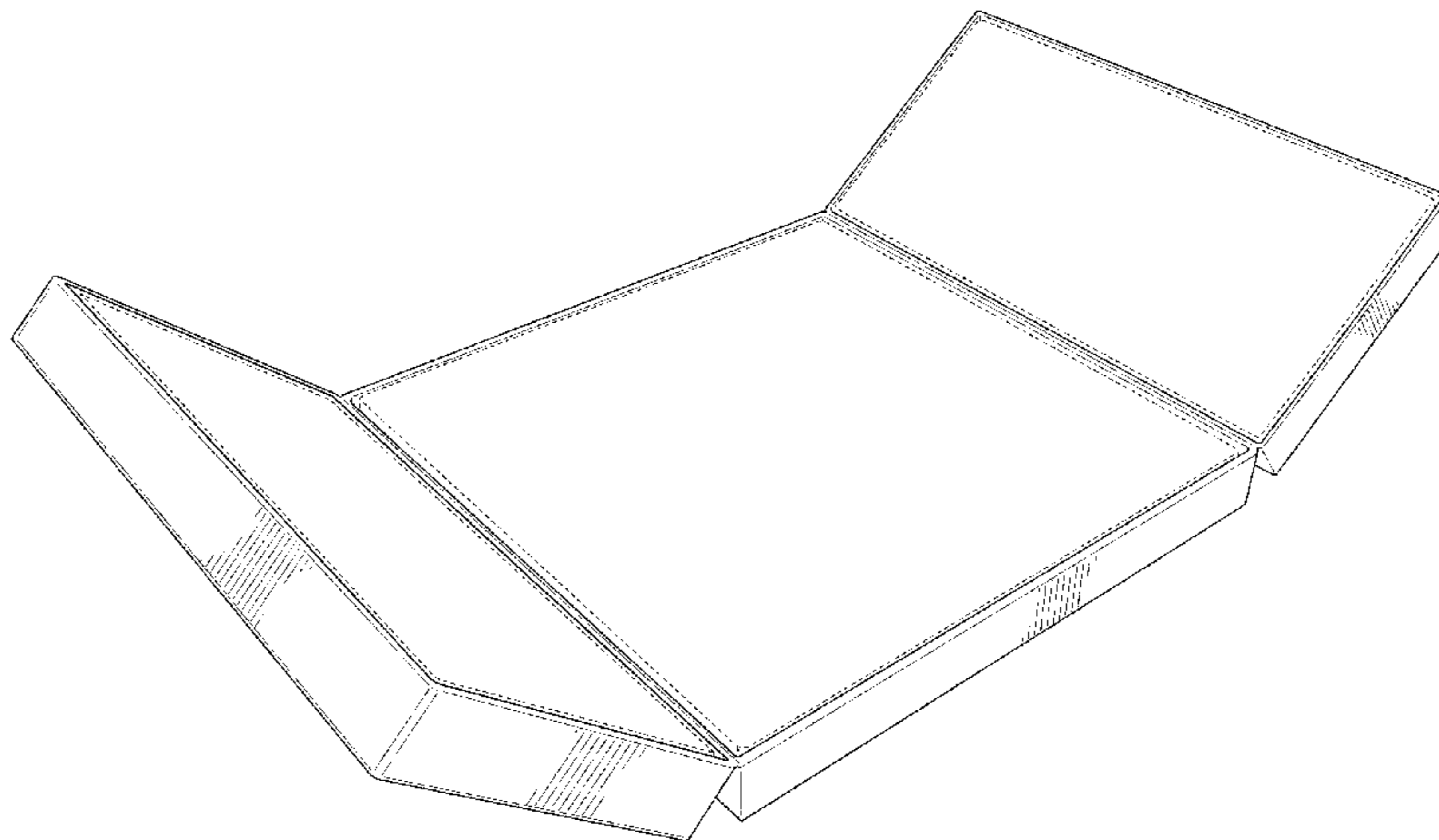

(58) **Field of Classification Search**

USPC ..... D9/753, 756, 741, 346, 347; D7/611, D7/550.1, 605, 701, 553.1, 553.2, 614, D7/590, 602; D3/313, 304, 311, 314, D3/315, 201, 203.1–203.3, 203.5, 203.6, D3/203.8, 205, 206, 218, 269, 273, 274, D3/294, 272, 288, 299, 295, 298, 901, D3/903; D24/227; D28/3, 64.1–64.7, D28/76–84, 73, 91; 206/139, 201–203, 206/427, 265, 504, 518, 519, 524.1, 557, 206/561, 564, 565, 703, 704, 705, 523, 206/586, 515, 581, 823, 216, 223, 532, 206/457, 503, 508, 509, 551, 746, 784, 206/822; 220/4.26, 4.21, 4.23, 836–839, 220/810, 244; 229/103.2, 120.02, 120.03, 229/123.1, 123.2, 123.3, 87.01, 87.06, 229/87.12–87.19, 92.7, 406, 407, 902, 229/905, 906, 938, 461, 541; 426/119, 426/112, 298, 614; 273/153 R, 157 R; 132/286–288, 293–301, 314–316; D6/300–314; 40/700, 733, 779  
 CPC ..... B65D 5/5495; B65D 85/1072; B65D 5/5253; B65D 85/1063; B65D 5/0085; B65D 21/0204; B65D 5/427; B65D 21/0201; B65D 5/009; B65D 77/006; B65D 85/324; B65D 85/32; B65D 71/70; B65D 85/322; B65D 2543/00194; B65D 2543/00296; B65D 2543/00361; A45D 40/22

See application file for complete search history.

(56) **References Cited**

U.S. PATENT DOCUMENTS

2,007,089 A \* 7/1935 Jones ..... B65D 5/5021  
 206/773  
 2,086,443 A \* 7/1937 Rutyna ..... A47G 1/14  
 40/733  
 2,329,866 A \* 9/1943 Sickels ..... B65D 5/38  
 206/256  
 D162,424 S \* 3/1951 Kulp ..... D3/295  
 D190,253 S \* 5/1961 Chlop ..... D3/10  
 3,755,925 A \* 9/1973 Court ..... B65D 5/4204  
 206/232  
 D240,292 S \* 6/1976 Beaumont ..... D9/421  
 4,287,986 A \* 9/1981 Beck ..... A45C 11/16  
 206/45.23  
 D262,461 S \* 12/1981 Holson ..... D19/26  
 4,307,806 A \* 12/1981 Haubert ..... G11B 23/023  
 206/232  
 D264,602 S \* 5/1982 Plutsky ..... D19/26  
 D265,989 S \* 8/1982 Harris ..... D13/184  
 4,609,104 A \* 9/1986 Kasper ..... B65D 75/38  
 174/365  
 4,919,259 A \* 4/1990 Beaulieu ..... A45C 7/0054  
 16/225  
 RE33,503 E \* 12/1990 Schluger ..... B65D 5/422  
 206/232  
 D326,279 S \* 5/1992 Logan ..... D19/113  
 5,167,205 A \* 12/1992 Bell ..... A01K 1/0125  
 119/168  
 D339,287 S \* 9/1993 Levin ..... D9/432  
 D362,972 S \* 10/1995 Wunsch ..... D9/737  
 D373,723 S \* 9/1996 Healey ..... D9/433  
 D373,754 S \* 9/1996 Pinterpe ..... D12/424  
 D385,781 S \* 11/1997 Levine ..... D9/423  
 D398,527 S \* 9/1998 Maceachern ..... D9/420  
 D399,135 S \* 10/1998 Mecca ..... D9/423  
 5,926,877 A \* 7/1999 Lin ..... A47C 20/041  
 297/330

D420,586 S \* 2/2000 MacEachern ..... D9/420  
 D431,188 S \* 9/2000 Monn ..... D3/295  
 D443,388 S \* 6/2001 Roberts et al.  
 D447,687 S \* 9/2001 Roby ..... D9/422  
 D458,128 S \* 6/2002 Gray ..... D9/432  
 D484,695 S \* 1/2004 DePalma ..... D3/284  
 D514,315 S \* 2/2006 Lai ..... D3/276  
 D517,911 S \* 3/2006 Alexander ..... D9/433  
 D518,709 S \* 4/2006 Connolly ..... D9/430  
 D519,367 S \* 4/2006 Alexander ..... D9/433  
 7,040,899 B2 \* 5/2006 Armstrong ..... G09F 15/0068  
 160/135  
 D530,913 S \* 10/2006 Chan ..... D3/281  
 D541,146 S \* 4/2007 Cale ..... D9/421  
 D552,300 S \* 10/2007 Dittmer ..... D28/83  
 D572,024 S \* 7/2008 Shapiro ..... D6/301  
 7,511,950 B1 \* 3/2009 Brekke ..... G06F 1/1616  
 248/917  
 D592,853 S \* 5/2009 Parker ..... D3/271.4  
 D594,510 S \* 6/2009 Sappington ..... D20/10  
 D600,964 S \* 9/2009 Elias ..... D6/407  
 D601,798 S \* 10/2009 Hsu ..... D3/295  
 7,607,699 B2 \* 10/2009 Langford ..... A45C 3/02  
 190/110  
 D609,696 S \* 2/2010 Martinez ..... D14/207  
 D610,350 S \* 2/2010 Smith ..... D3/294  
 D620,352 S \* 7/2010 Liipola ..... D9/432  
 D626,831 S \* 11/2010 Nicholas ..... D9/432  
 D627,931 S \* 11/2010 Barresi ..... D28/83  
 8,033,393 B2 \* 10/2011 Baker ..... A43D 95/12  
 15/227  
 D653,854 S \* 2/2012 Chamberlain ..... D3/294  
 D657,156 S \* 4/2012 Shih ..... D6/361  
 D666,818 S \* 9/2012 Mbi ..... D3/284  
 D682,680 S \* 5/2013 Terlesky ..... D9/432  
 D687,293 S \* 8/2013 Glass ..... D9/415  
 D687,601 S \* 8/2013 Ko ..... D28/77  
 D688,420 S \* 8/2013 Lai ..... D28/83  
 D691,802 S \* 10/2013 Lin ..... D3/282  
 D708,055 S \* 7/2014 Elston ..... D9/423  
 D712,251 S \* 9/2014 Scott  
 D714,136 S \* 9/2014 Stepanov ..... D9/432  
 D716,649 S \* 11/2014 McAdam  
 D717,164 S \* 11/2014 Rossiter ..... D6/634  
 D724,941 S \* 3/2015 Mattila ..... D9/432  
 D724,942 S \* 3/2015 Mattila ..... D9/432  
 D726,819 S \* 4/2015 Botha ..... D19/75  
 D730,173 S \* 5/2015 Barad ..... D9/422  
 D730,175 S \* 5/2015 Barad ..... D9/432  
 D730,646 S \* 6/2015 DeChant ..... D3/247  
 D730,742 S \* 6/2015 Glass ..... D9/418  
 D733,557 S \* 7/2015 McAdam ..... D9/432  
 D737,688 S \* 9/2015 Stone  
 D738,721 S \* 9/2015 Song ..... D9/432  
 D739,228 S \* 9/2015 Jondal ..... D9/421  
 D751,498 S \* 3/2016 Munshi ..... D13/102  
 D752,863 S \* 4/2016 Torggler ..... D3/273  
 D754,598 S \* 4/2016 Munshi ..... D13/102  
 D755,118 S \* 5/2016 Munshi ..... D13/102  
 D755,119 S \* 5/2016 Munshi ..... D13/102  
 D758,851 S \* 6/2016 Binder ..... D9/432  
 D762,487 S \* 8/2016 Safiullin ..... D9/756  
 D766,713 S \* 9/2016 Kiss ..... D9/421  
 D772,559 S \* 11/2016 Binder ..... D3/203.6  
 D783,547 S \* 4/2017 Bergmann ..... D13/180  
 D785,939 S \* 5/2017 Cooper ..... D14/250  
 2005/0155259 A1 \* 7/2005 Virvo ..... G09F 1/06  
 40/124.09  
 2007/0251856 A1 \* 11/2007 Zietlow ..... B65D 5/5028  
 206/586  
 2008/0041870 A1 \* 2/2008 Smith ..... B42F 7/14  
 220/826  
 2010/0126891 A1 \* 5/2010 Schafer ..... B65D 25/10  
 206/307

(56)

**References Cited**

U.S. PATENT DOCUMENTS

2015/0102093 A1\* 4/2015 Melistas ..... B65D 5/48018  
229/120.08  
2015/0144512 A1\* 5/2015 D'Alfonso ..... B65D 5/422  
206/256  
2016/0068296 A1\* 3/2016 Dammeyer ..... B65D 5/009  
206/335

OTHER PUBLICATIONS

UA HealthBox Press Kit (via HTC), available Apr. 1, 2016, [online], [site visited May 14, 2017]. Available from internet, <URL:https://web.archive.org/web/20160401022524/https://www.htc.com/us/about/newsroom/ua-healthbox-press-kit/\*

Gate Fold Boxes, available May 14, 2017, [online], [site visited May 14, 2017]. Available from internet, <URL:http://www.sunpack.com/boxes/gate-fold-boxes/\*

\* cited by examiner

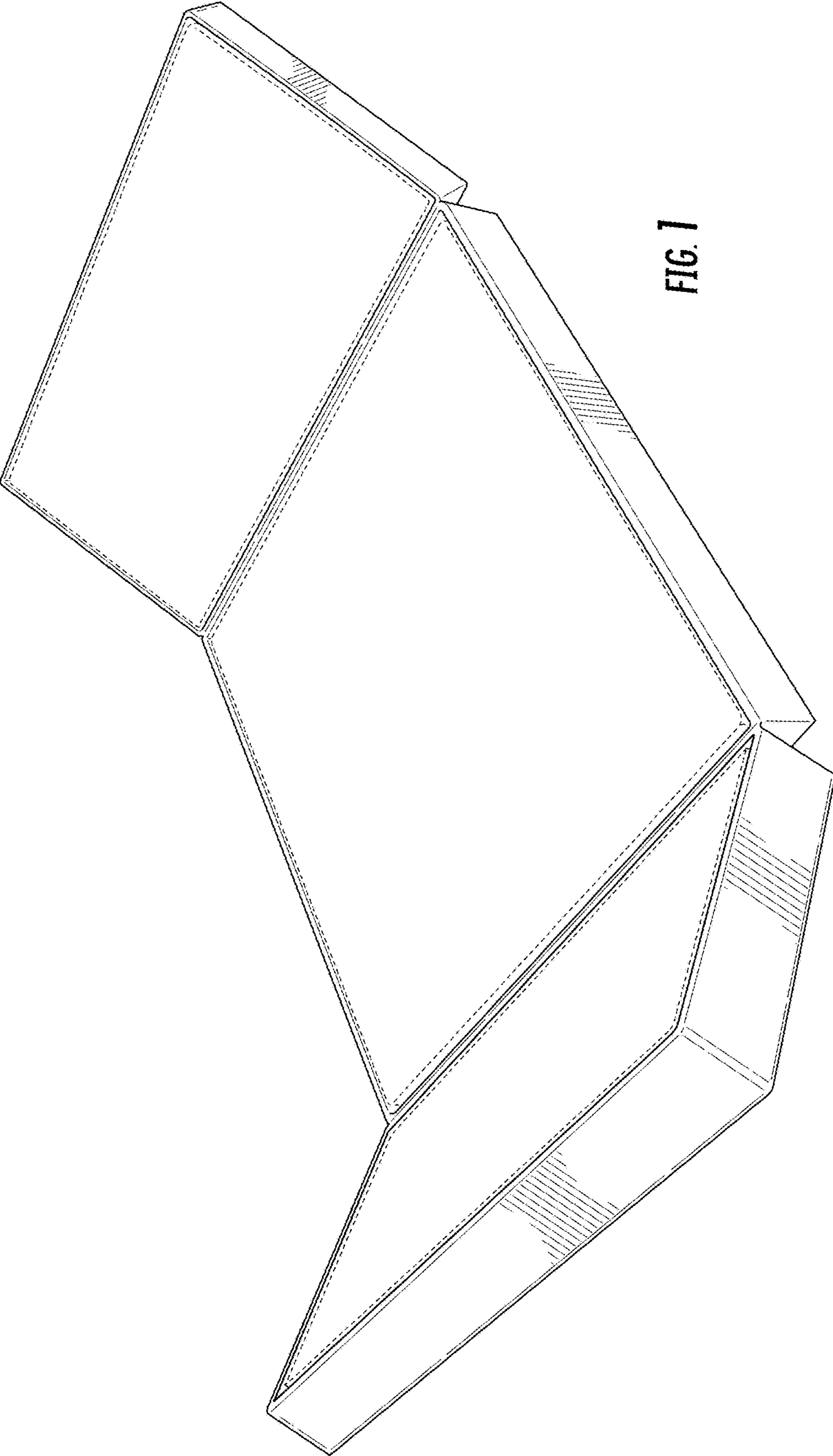

FIG. 1

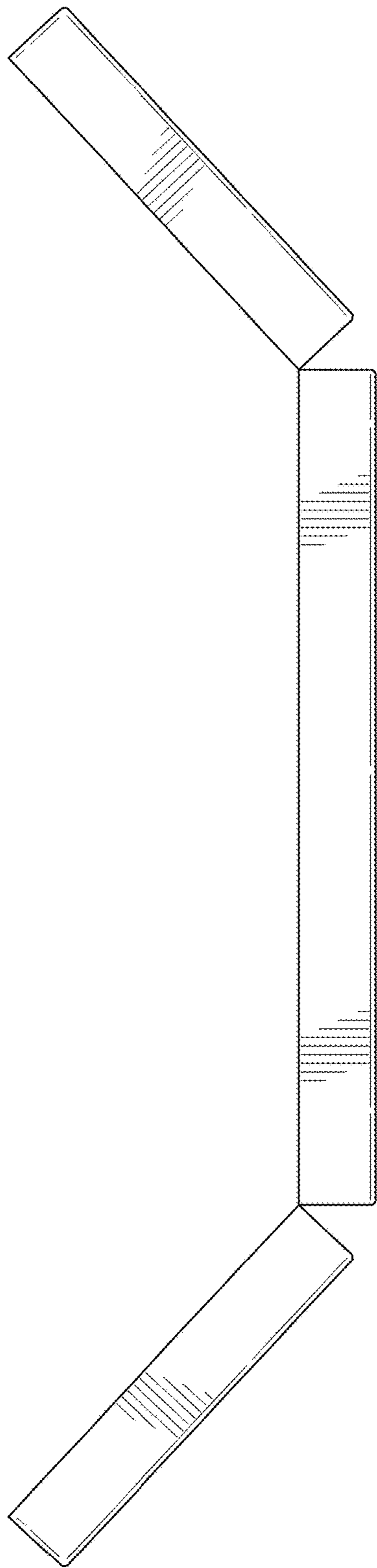

FIG. 2

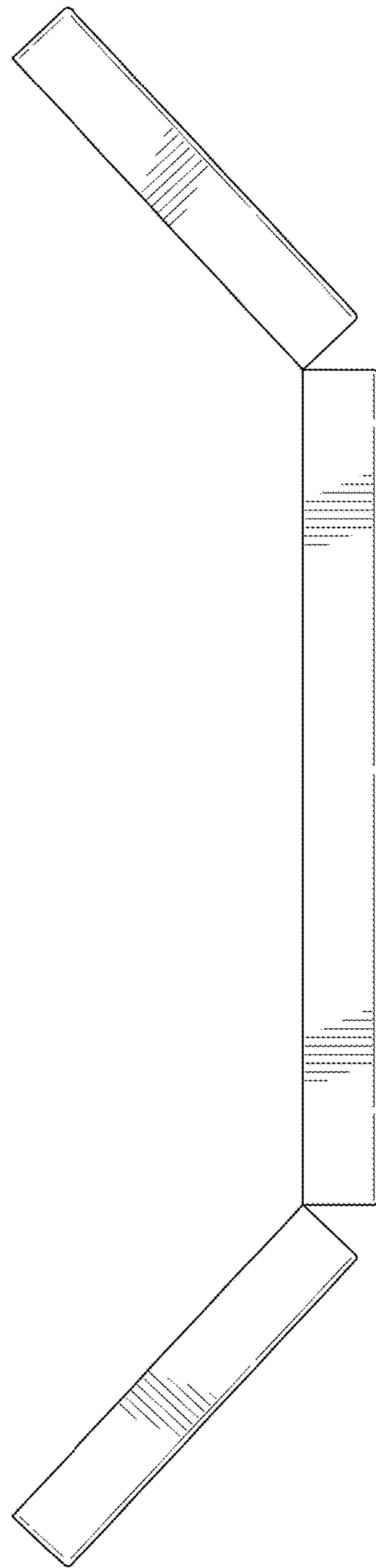
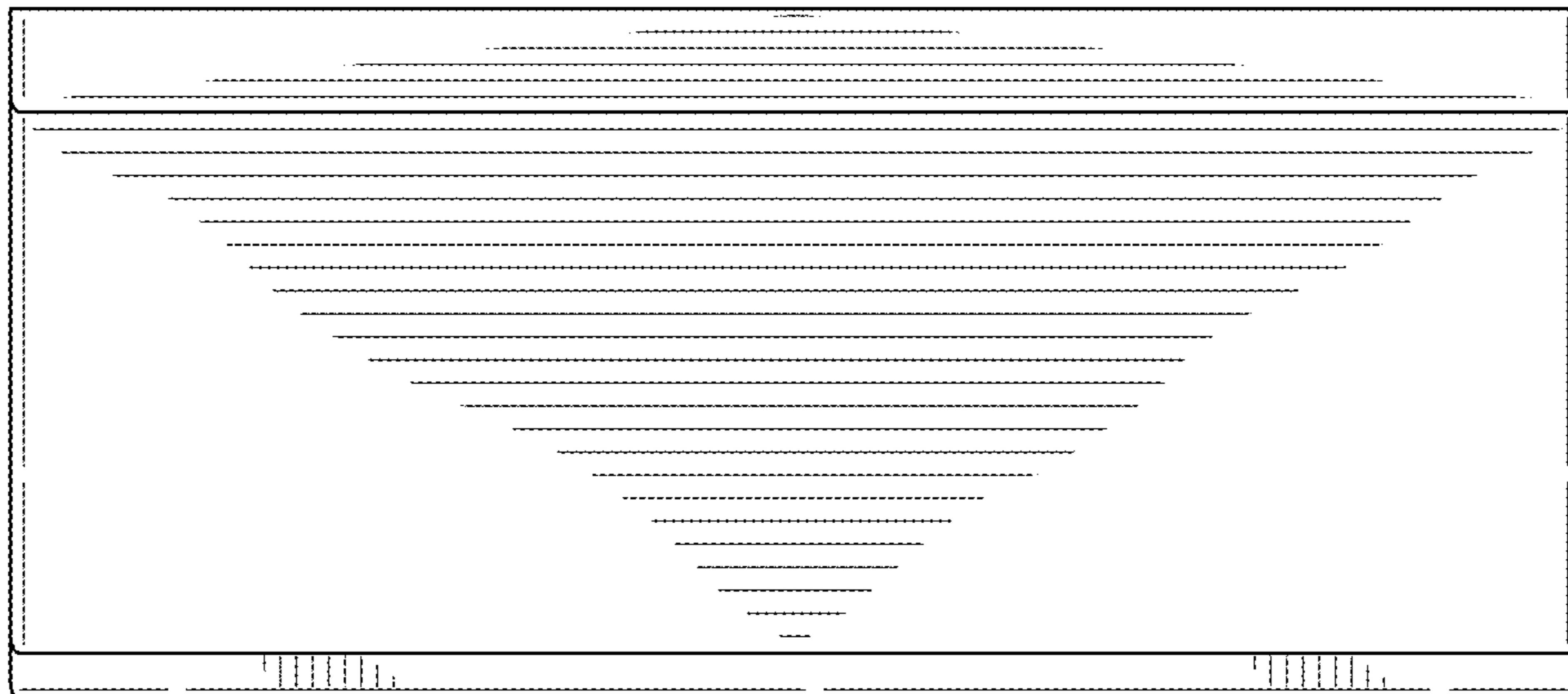
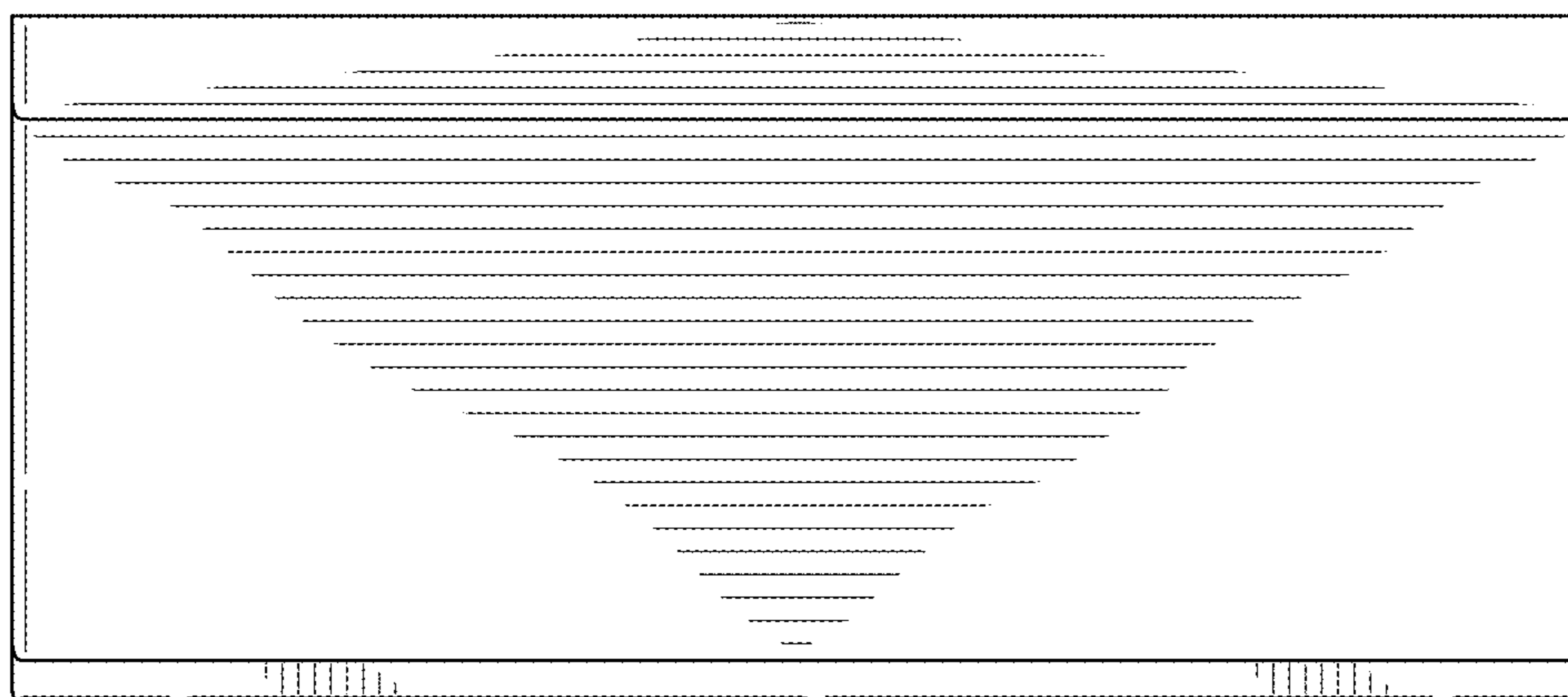

FIG. 3



**FIG. 4**



**FIG. 5**

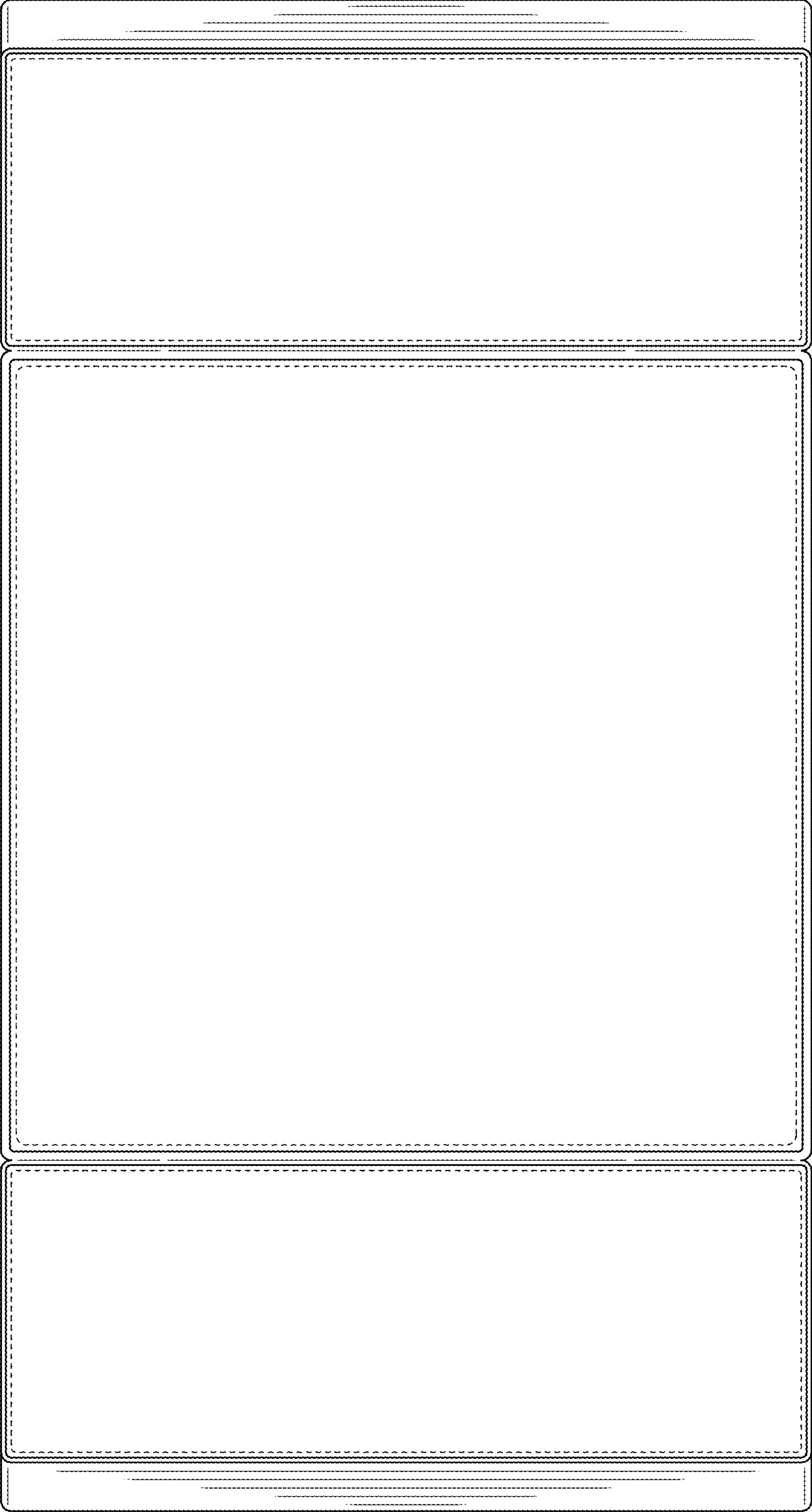

FIG. 6

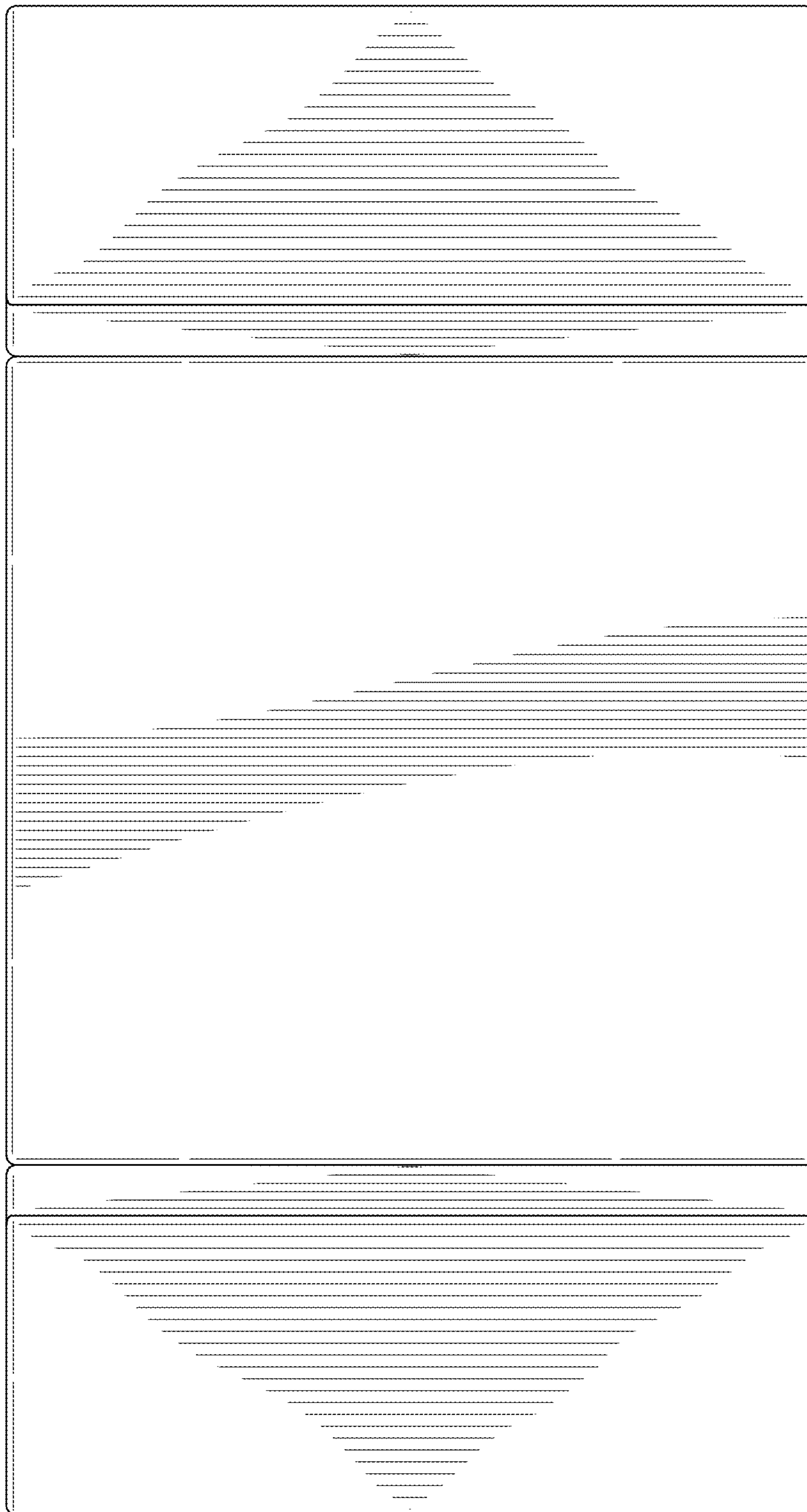

FIG. 7



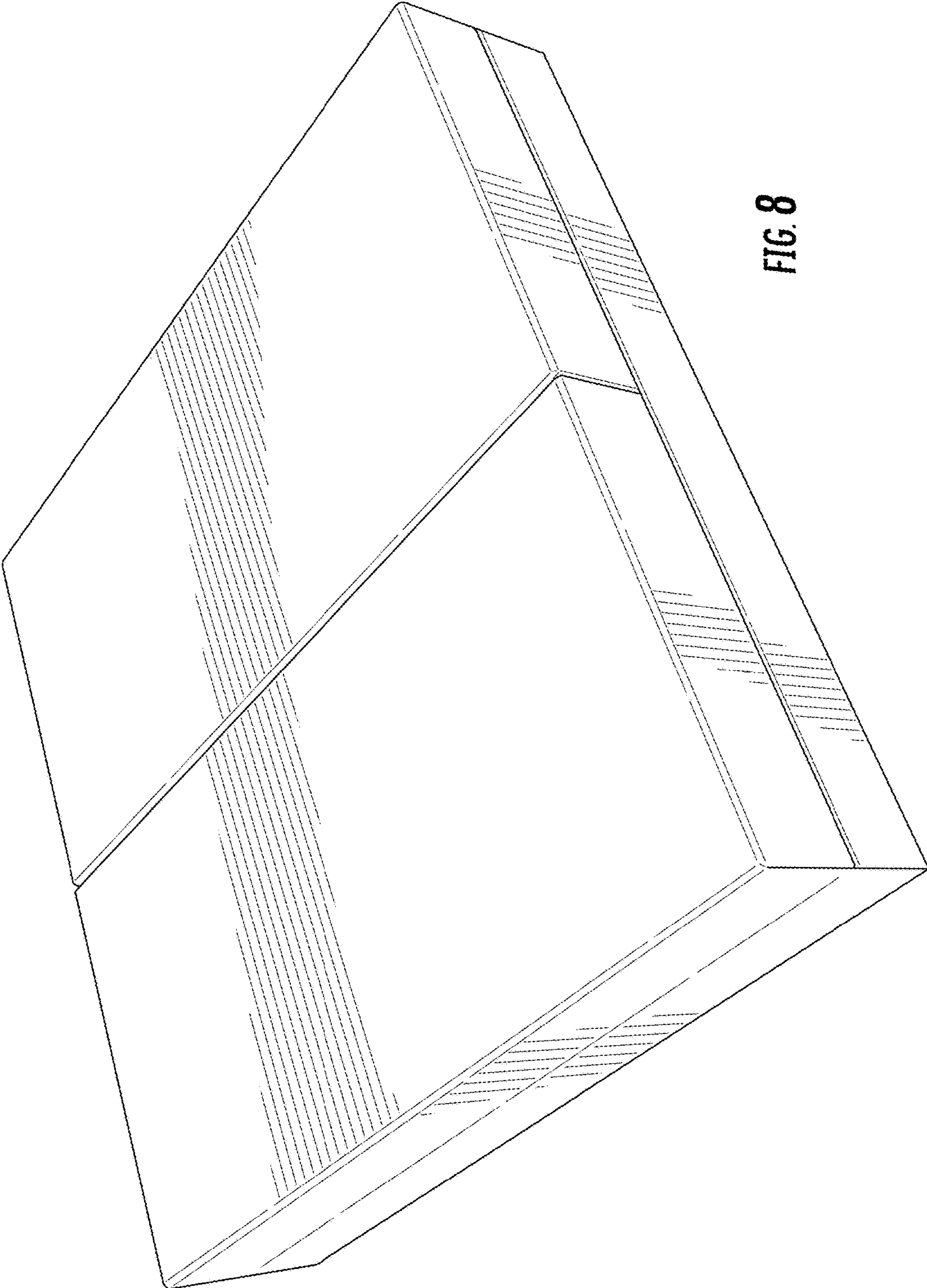

FIG. 8

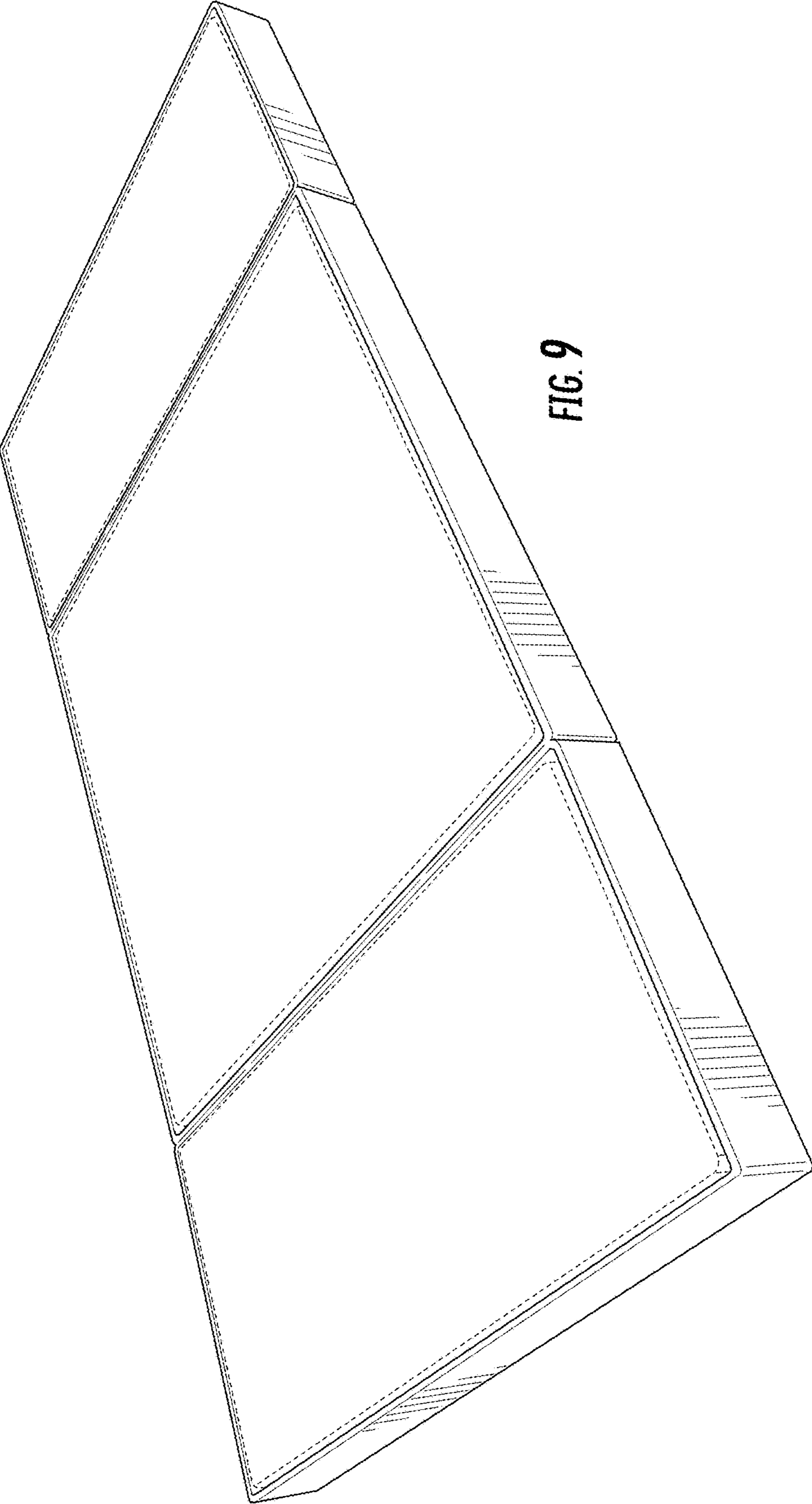

FIG. 9