



US00D805335S

(12) **United States Design Patent** (10) **Patent No.:** **US D805,335 S**  
**Itou** (45) **Date of Patent:** **\*\* Dec. 19, 2017**

- (54) **TABLE**
- (71) Applicant: **OKAMURA CORPORATION**,  
Yokohama-shi, Kanagawa (JP)
- (72) Inventor: **Masaru Itou**, Yokohama (JP)
- (73) Assignee: **Okamura Corporation**, Yokohama-shi,  
Kanagawa (JP)
- (\*\*) Term: **15 Years**
- (21) Appl. No.: **29/526,781**
- (22) Filed: **May 13, 2015**
- (51) **LOC (10) Cl.** ..... **06-06**
- (52) **U.S. Cl.**  
USPC ..... **D6/709.2**
- (58) **Field of Classification Search**  
USPC ..... D6/648.1, 656, 656.12, 656.17, 708.23,  
D6/709, 709.21, 710, 718  
CPC .... A47B 1/00; A47B 1/08; A47B 1/10; A47B  
9/00; A47B 9/08; A47B 9/20; A47B 9/18;  
A47B 87/002; A47B 7/00; A47B  
2021/11; A47B 13/00; A47B 13/02; A47B  
13/04; A47B 91/00; A47B 2200/002;  
A47B 2200/0031  
See application file for complete search history.

- (56) **References Cited**  
U.S. PATENT DOCUMENTS  
1,875,377 A \* 9/1932 Hanson ..... A47B 13/00  
108/150  
2,787,087 A \* 4/1957 Whitman ..... A47B 91/16  
108/150  
D199,671 S \* 12/1964 Malhaueer ..... D6/708.23  
D200,403 S \* 2/1965 Petiet ..... D6/708.23  
D204,189 S \* 3/1966 Dillen ..... D6/708.23  
3,278,147 A \* 10/1966 Olander ..... D06F 81/00  
248/188.3

- D207,958 S \* 6/1967 Jakobsen ..... D6/708.16
- D223,498 S \* 4/1972 Daum ..... D6/709
- 3,796,169 A \* 3/1974 Bales ..... A47B 3/0815  
108/116
- 3,855,947 A \* 12/1974 Henley ..... A47B 91/16  
108/161
- D236,058 S \* 7/1975 Kramer ..... D6/656.17
- D236,402 S \* 8/1975 Lubke ..... D6/692.4
- D239,073 S \* 3/1976 George ..... D6/708
- D276,864 S \* 12/1984 Ponzellini ..... D6/709
- D278,012 S \* 3/1985 Doerner ..... D6/610
- D314,299 S \* 2/1991 Diffrient ..... D6/709
- D322,373 S \* 12/1991 Gutgsell ..... D6/708.23
- D322,729 S \* 12/1991 Diffrient ..... D6/656.17
- D324,615 S \* 3/1992 Diffrient ..... D6/709
- D350,446 S \* 9/1994 Sauvage ..... D6/692
- D372,150 S \* 7/1996 Funk ..... D6/708
- D379,127 S \* 5/1997 Schacht ..... D6/709
- D379,411 S \* 5/1997 Funk ..... D6/709

(Continued)

*Primary Examiner* — David G Muller  
*Assistant Examiner* — Nathan M Johnston  
(74) *Attorney, Agent, or Firm* — Sughrue Mion, PLLC

(57) **CLAIM**

The ornamental design for a table, as shown and described.

**DESCRIPTION**

FIG. 1 is a perspective view of a table.  
FIG. 2 is a front elevation view thereof. A rear elevation view is a mirror image of the front elevation view.  
FIG. 3 is a left side elevation view thereof.  
FIG. 4 is a top plan view thereof.  
FIG. 5 is a bottom plan view thereof.  
FIG. 6 is an enlarged cross-sectional view taken along the line 6-6 in FIG. 4; and,  
FIG. 7 is an enlarged cross-sectional view taken along the line 7-7 in FIG. 4.  
The broken lines shown in the drawings illustrate portions of the table that form no part of the claimed design.

**1 Claim, 7 Drawing Sheets**

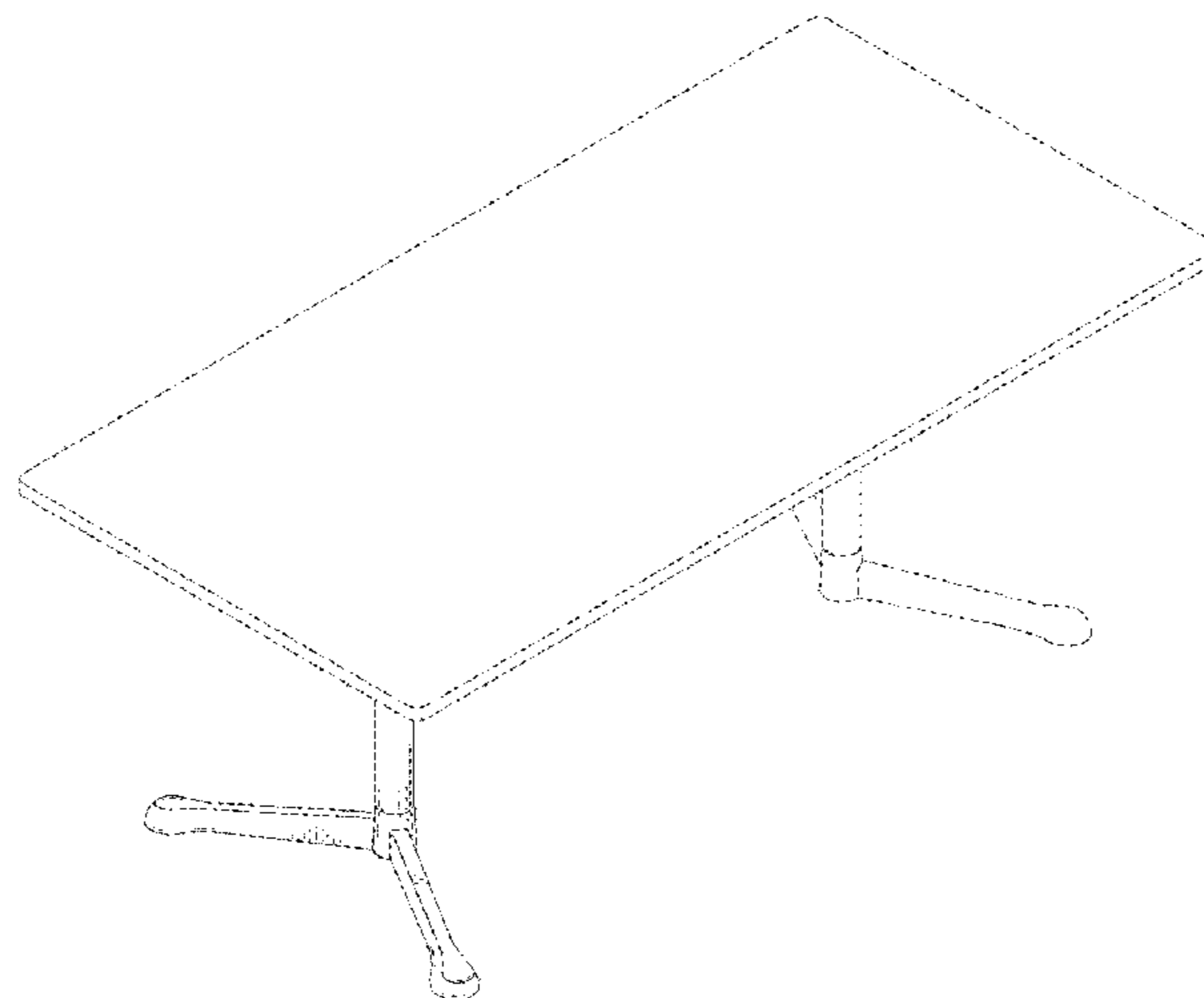

(56)

References Cited

U.S. PATENT DOCUMENTS

D380,632 S *	7/1997	Schacht .....	D6/709	D562,037 S *	2/2008	Kaloustian .....	D6/708.23
D409,861 S *	5/1999	Newhouse .....	D6/708.23	D569,136 S *	5/2008	Pearsons .....	D6/708.23
D431,739 S *	10/2000	Rives .....	D6/709	D569,662 S *	5/2008	Simonsen .....	D6/709
D444,325 S *	7/2001	DeJule .....	D6/709	D569,663 S *	5/2008	Pearsons .....	D6/708.23
D447,895 S *	9/2001	Chen .....	D6/366	D583,594 S *	12/2008	Tamara .....	D6/708.23
D458,060 S *	6/2002	Vo .....	D6/366	D585,218 S *	1/2009	Hamilton .....	D6/656
D458,776 S *	6/2002	Patton .....	D6/366	D585,669 S *	2/2009	Gharabegian .....	D6/692.4
D461,072 S *	8/2002	Ko .....	D6/709	D622,984 S *	9/2010	Babick .....	D6/709
D471,039 S *	3/2003	Chen .....	D6/366	D634,949 S *	3/2011	Babick .....	D6/709
D472,079 S *	3/2003	Chen .....	D6/708.23	D640,075 S *	6/2011	Petrick .....	D6/656.17
D475,557 S *	6/2003	Su .....	D6/366	D644,046 S *	8/2011	Cronk .....	D6/656.17
D482,217 S *	11/2003	Lin .....	D6/366	D644,455 S *	9/2011	Wilson .....	D6/644
D482,549 S *	11/2003	Tsai .....	D6/366	D644,457 S *	9/2011	Wilson .....	D6/644
D494,786 S *	8/2004	Cheng .....	D6/366	D653,479 S *	2/2012	Babick .....	D6/709
D494,787 S *	8/2004	Fu .....	D6/366	D653,480 S *	2/2012	Tsai .....	D6/708.23
D498,091 S *	11/2004	Winter .....	D6/709	D665,603 S *	8/2012	Huang .....	D6/708.23
D499,586 S *	12/2004	Fu .....	D6/366	8,607,715 B2 *	12/2013	Catoni .....	F16M 7/00 108/150
D507,436 S *	7/2005	Chao .....	D6/366	D721,244 S *	1/2015	Mueller .....	D6/709
D513,140 S *	12/2005	Strong .....	D6/709.2	D722,801 S *	2/2015	Tamura .....	D6/708
D518,318 S *	4/2006	Koepke .....	D6/708.23	D723,849 S *	3/2015	Mueller .....	D6/709
D524,582 S *	7/2006	Tsai .....	D6/366	D759,412 S *	6/2016	Koning .....	D6/709
D549,014 S *	8/2007	Donati .....	D6/708.23	D763,609 S *	8/2016	Copier .....	D6/709
D555,945 S *	11/2007	Pearsons .....	D6/709	9,414,676 B1 *	8/2016	Raffi .....	A47B 91/16
D560,406 S *	1/2008	Privatt .....	D6/708.23	D782,236 S *	3/2017	Wu .....	D6/708.23
				D782,855 S *	4/2017	Scagnellato .....	D6/685
				2017/0065074 A1 *	3/2017	Ilse .....	A47B 3/0803

\* cited by examiner

FIG. 1

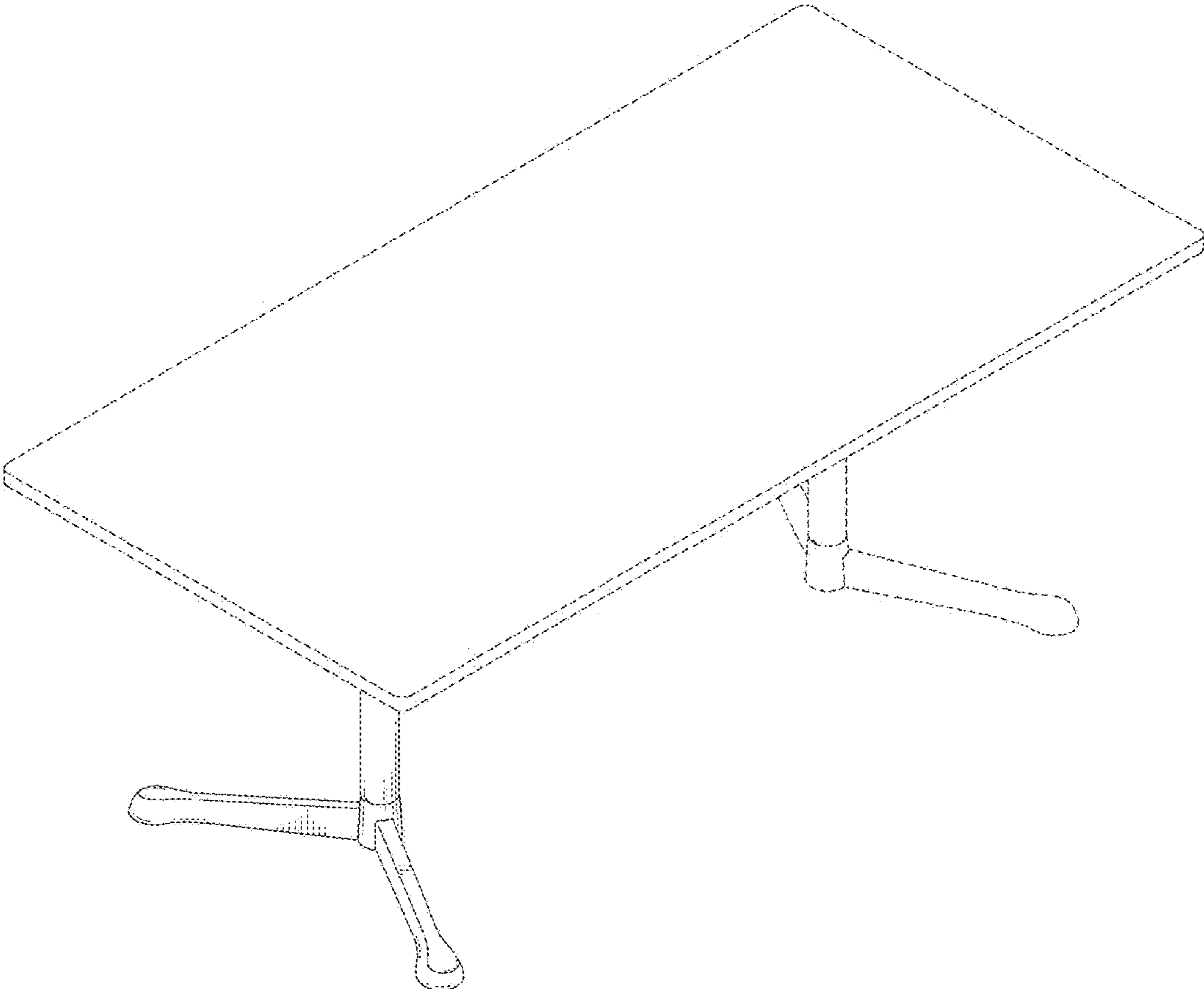

FIG. 2

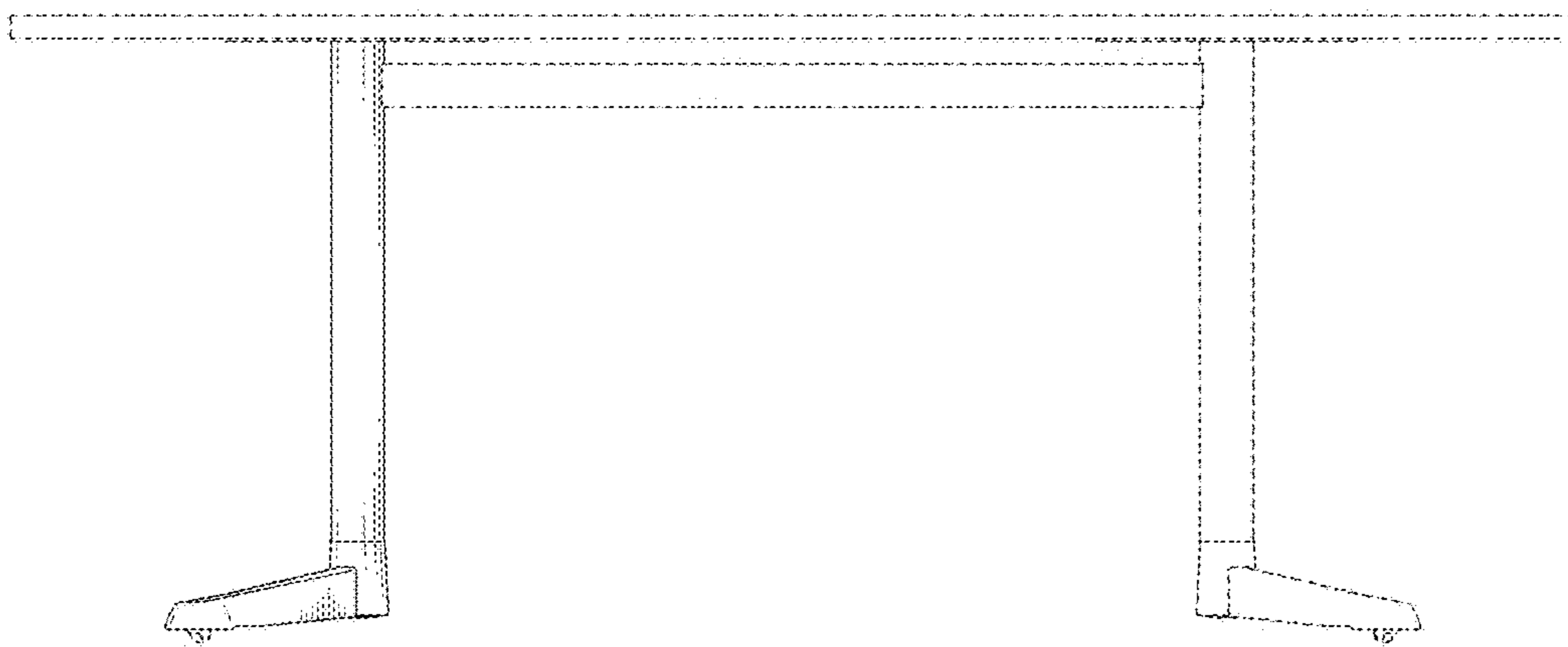

FIG. 3

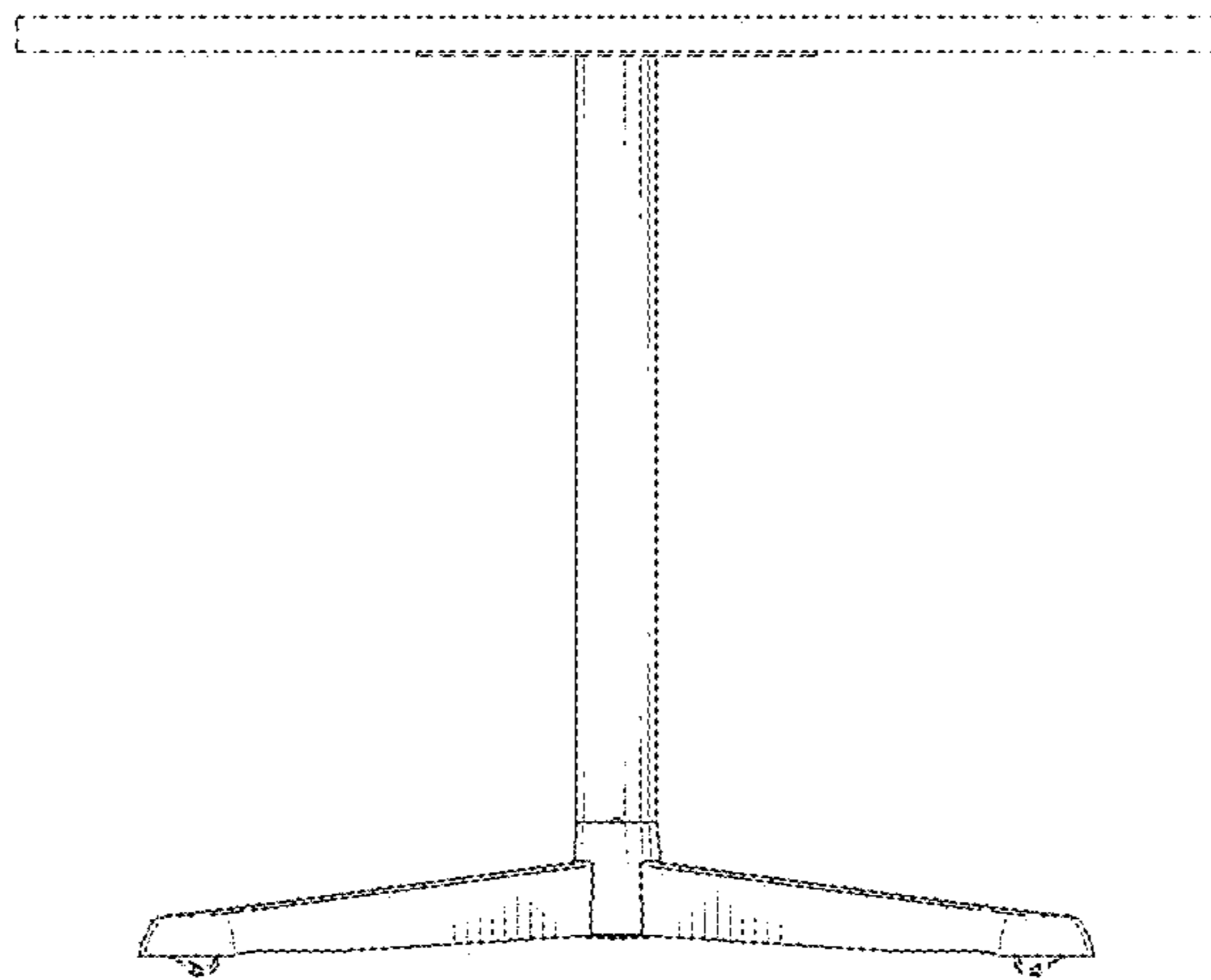

FIG. 4

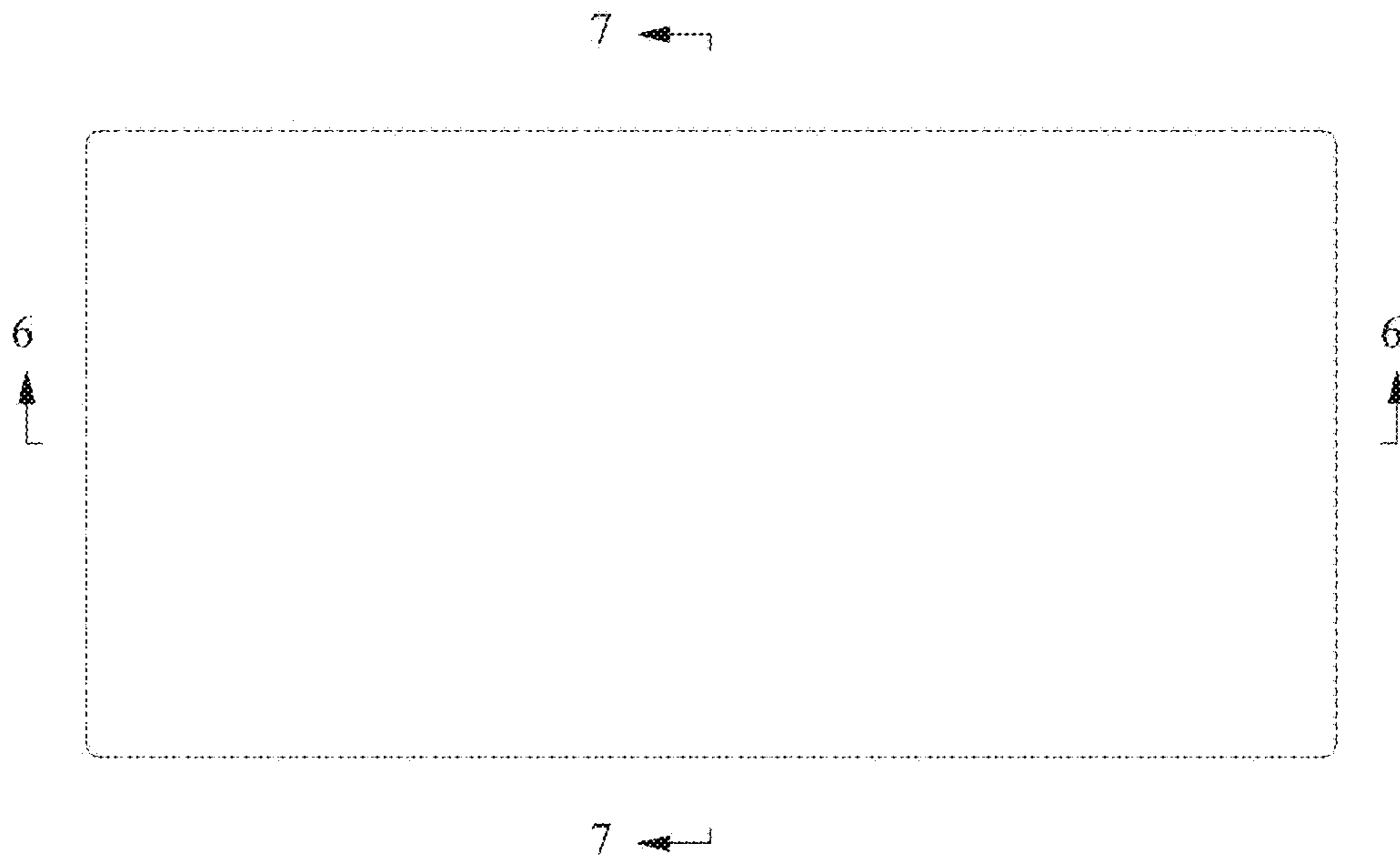

FIG. 5

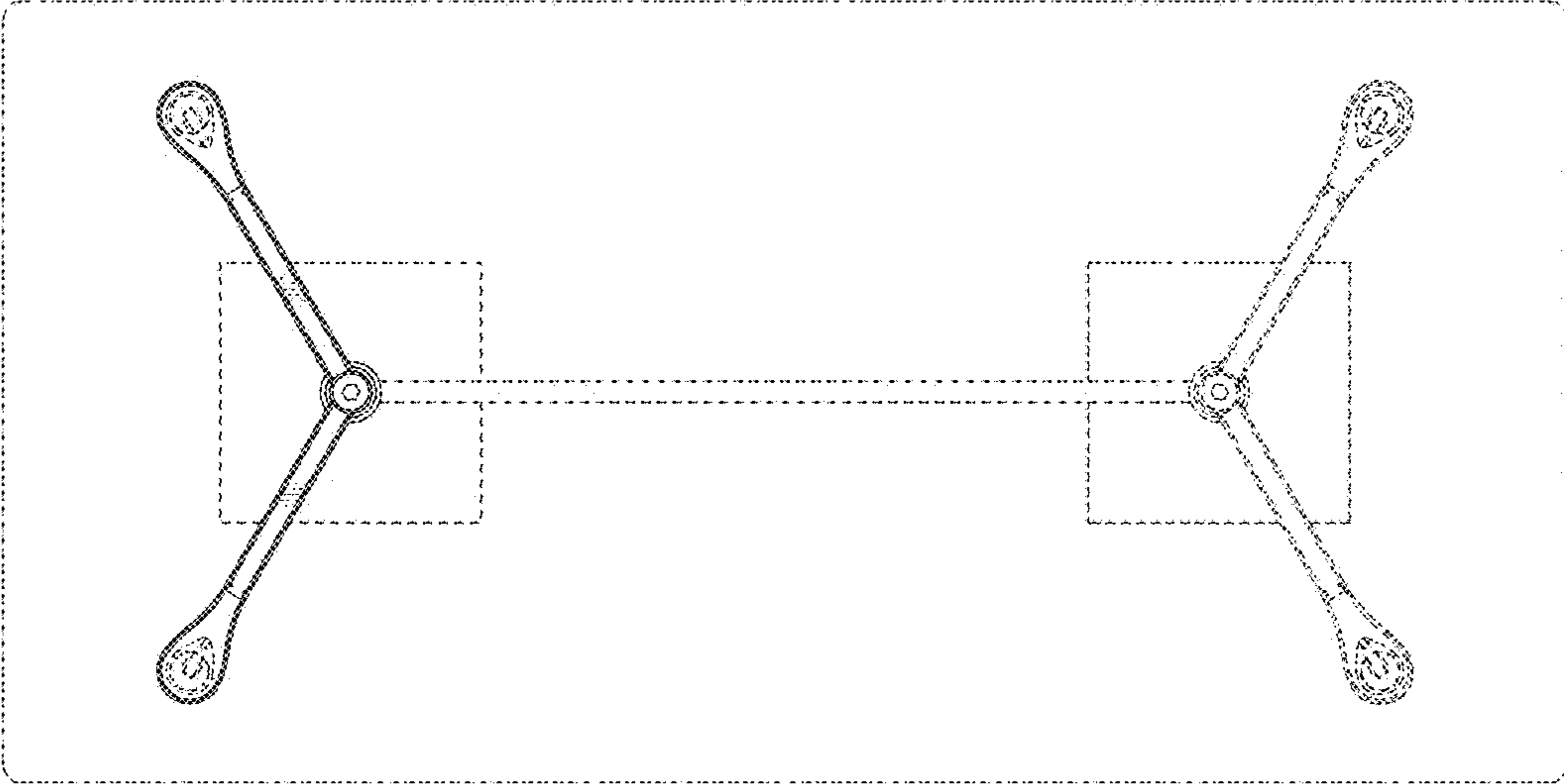



FIG. 6

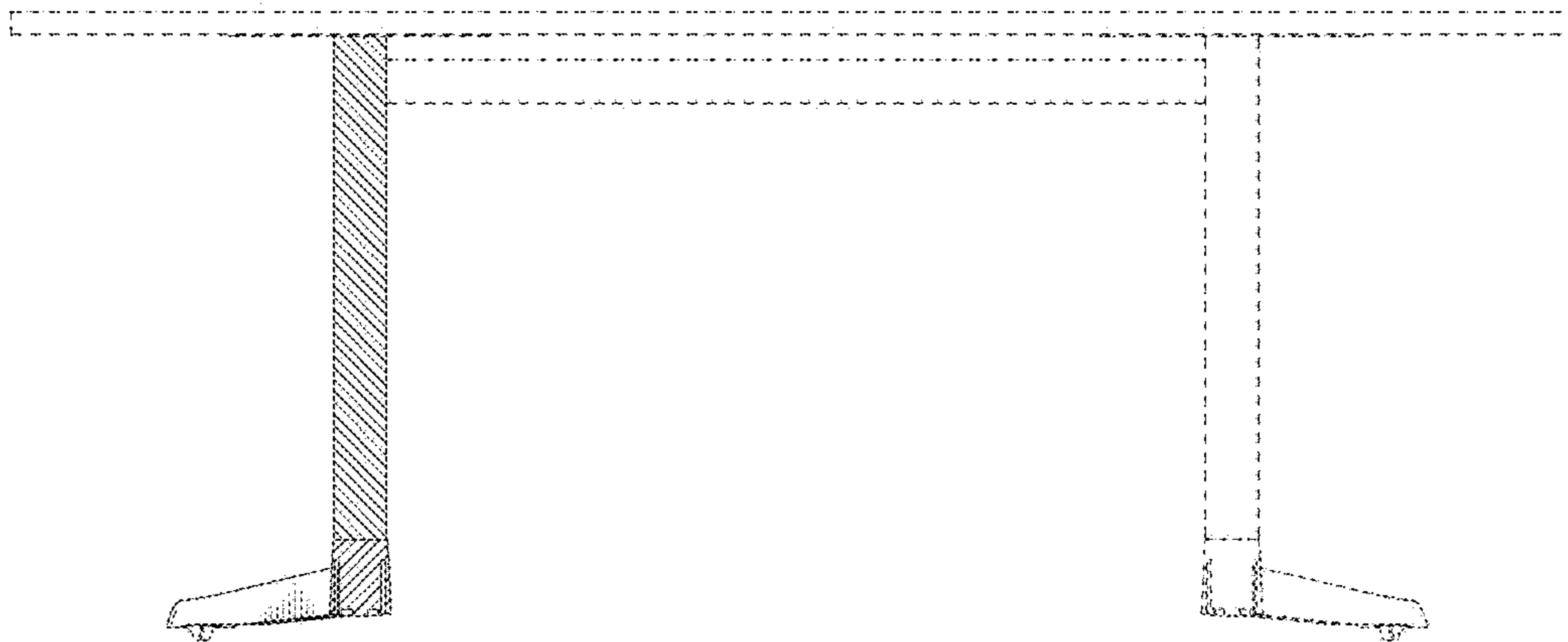



FIG. 7

