



US00D805294S

(12) **United States Design Patent** (10) **Patent No.:** **US D805,294 S**
Edwards et al. (45) **Date of Patent:** **** Dec. 19, 2017**

- (54) **PILL CONTAINER**
- (71) Applicant: **Breeden Brothers, LLC**, Nashville, TN (US)
- (72) Inventors: **Duncan Edwards**, Bronx, NY (US); **Chuya Lee**, New York, NY (US)
- (73) Assignee: **Breeden Brothers, LLC**, Nashville, TN (US)
- (**) Term: **15 Years**
- (21) Appl. No.: **29/586,996**
- (22) Filed: **Dec. 8, 2016**
- (51) **LOC (10) Cl.** **03-01**
- (52) **U.S. Cl.**
USPC **D3/203.2**
- (58) **Field of Classification Search**
USPC D3/202, 203, 213, 214, 215, 201, 226, D3/228, 224, 327, 229, 273, 290, 294, D3/243, 245, 246, 266, 904, 304, 307, D3/308, 309, 315; D7/509, 510, 511
CPC A45D 42/00; A45D 42/18; A61B 1/24; D04B 3/02; G05G 9/04788; A44B 11/25
See application file for complete search history.

- D649,777 S * 12/2011 Tyybakinoja D3/203.1
- D656,308 S * 3/2012 Sham D3/203.1
- D663,944 S * 7/2012 Bouskill D3/203.1
- D693,114 S * 11/2013 Lemanski, Sr. D3/203.8
- D738,208 S * 9/2015 Diehl D9/435
- D747,606 S * 1/2016 Serell D3/203.2
- D747,868 S * 1/2016 Steka D3/201
- D781,572 S * 3/2017 Duval D3/215

* cited by examiner

Primary Examiner — John Windmuller

Assistant Examiner — Benjamin Weeks

(74) *Attorney, Agent, or Firm* — Parker Ibrahim & Berg LLC; Kenneth J. Heywood; Robert M. Amici

(57) **CLAIM**

The ornamental design for a pill container, as shown and described.

DESCRIPTION

FIG. 1 is a front perspective view of a pill container while closed showing my new design;
 FIG. 2 is a front view thereof while closed;
 FIG. 3 is a rear view thereof while closed;
 FIG. 4 is a left side view thereof while closed;
 FIG. 5 is a right side view thereof while closed;
 FIG. 6 is a top side view thereof while closed;
 FIG. 7 is a bottom side view thereof while closed;
 FIG. 8 is a front perspective view thereof while open;
 FIG. 9 is a front view thereof while open;
 FIG. 10 is a rear view thereof while open;
 FIG. 11 is a left side view thereof while open;
 FIG. 12 is a right side view thereof while open;
 FIG. 13 is a top side view thereof while open; and,
 FIG. 14 is a bottom side view thereof while open.
 Portions shown in the figures in broken lines form no part of the claimed design.

1 Claim, 10 Drawing Sheets

(56) **References Cited**

U.S. PATENT DOCUMENTS

- D111,536 S * 9/1938 Graff D3/295
- D233,078 S * 10/1974 Mullins D28/78
- D307,354 S * 4/1990 Knotter D3/294
- D309,264 S * 7/1990 Forbes, Jr. D9/438
- D483,911 S * 12/2003 Prince D28/64.1
- D496,133 S * 9/2004 Dittmer D28/83
- D549,053 S * 8/2007 Dellaferrera D3/294
- D560,487 S * 1/2008 Boettcher D3/294
- D595,839 S * 7/2009 Miazga D24/107

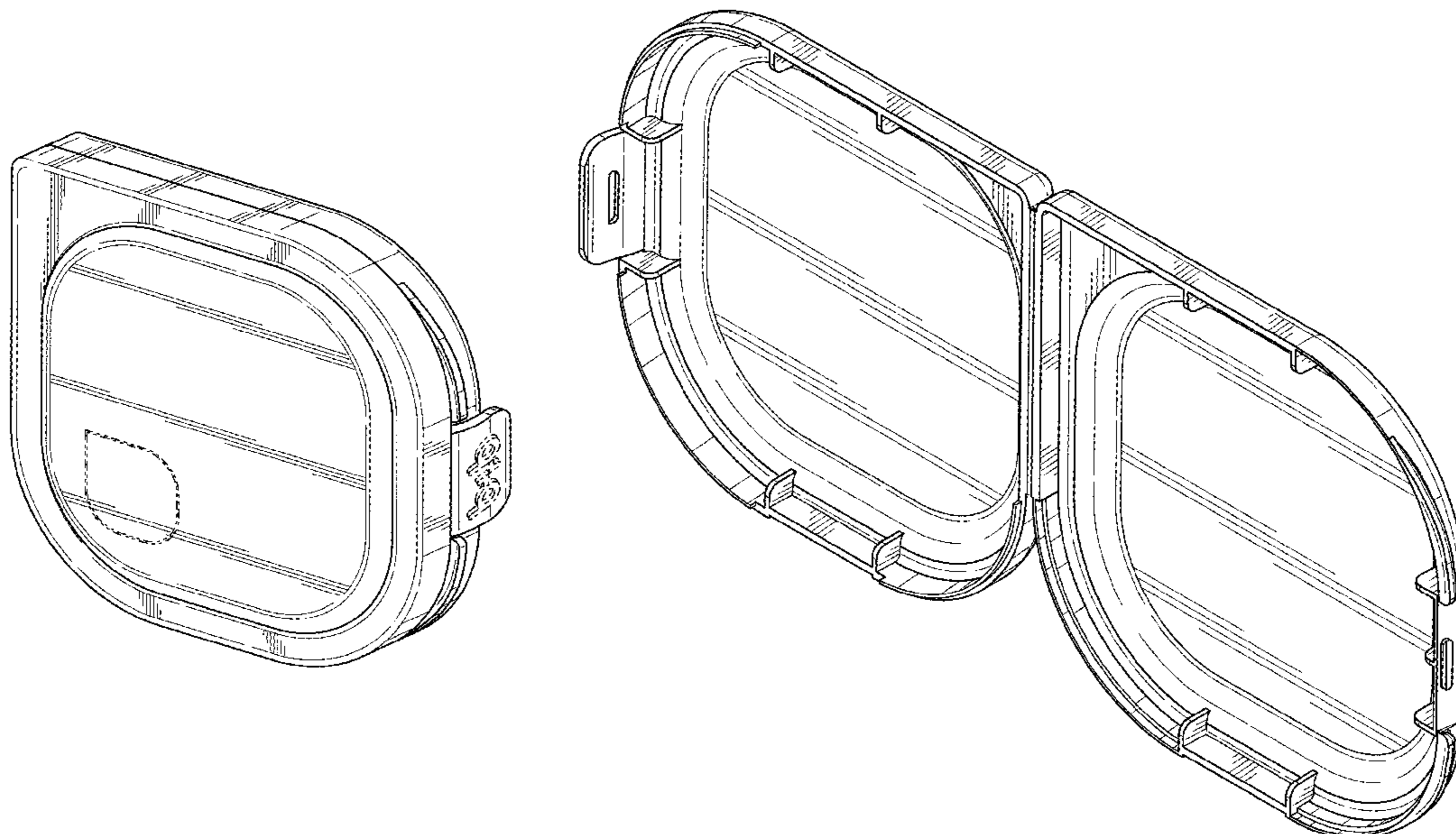

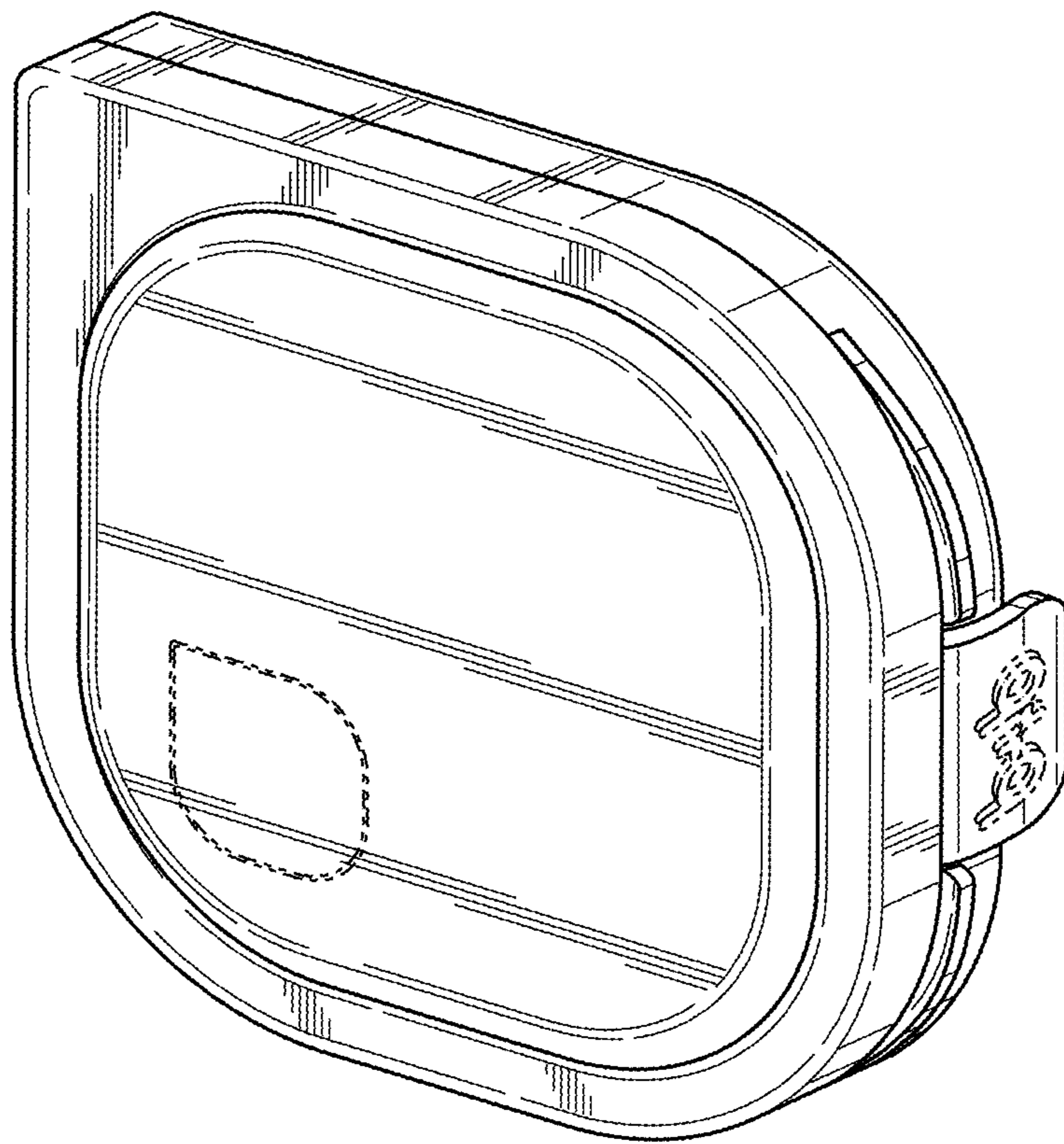

FIG. 1

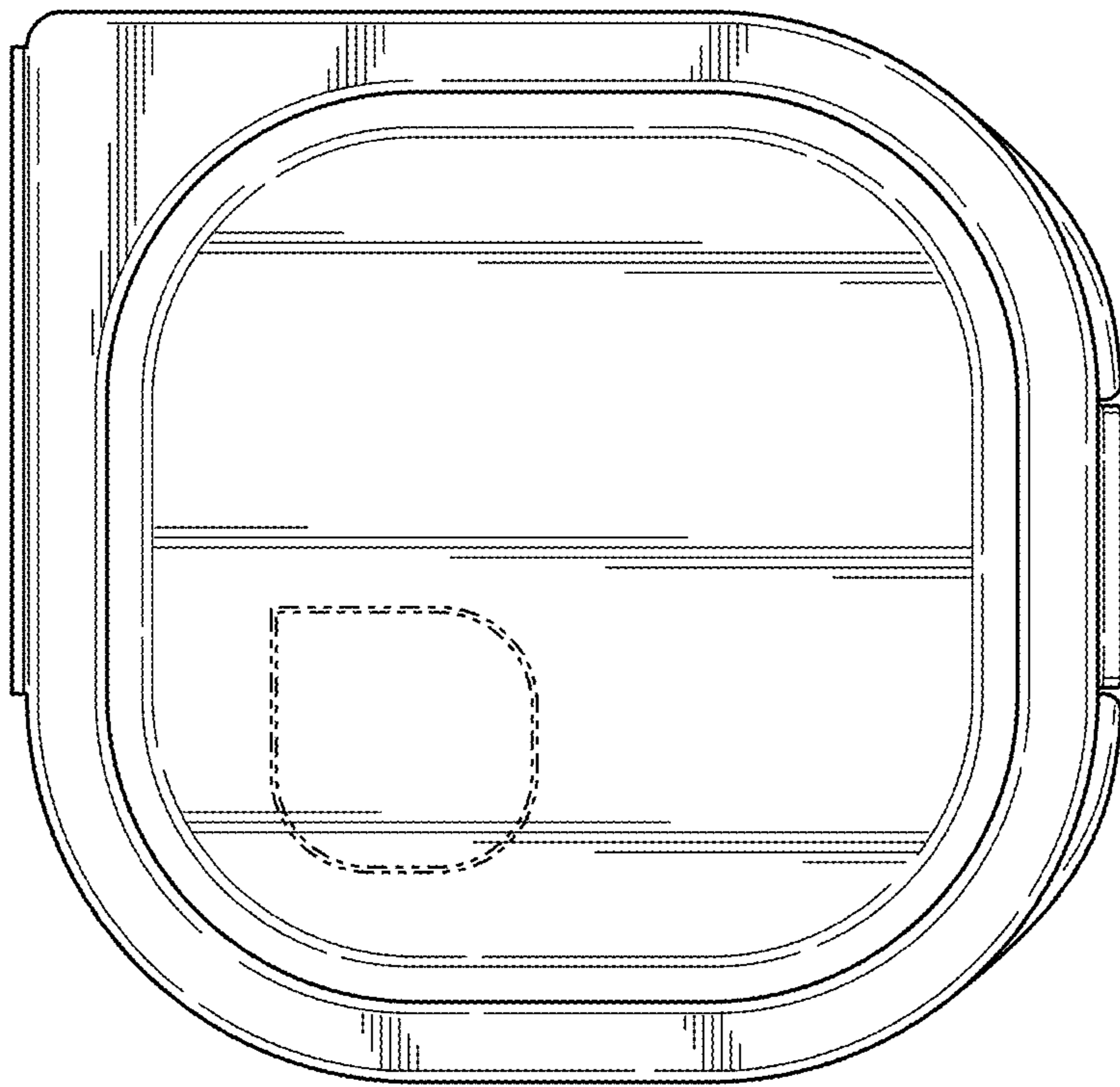

FIG. 2

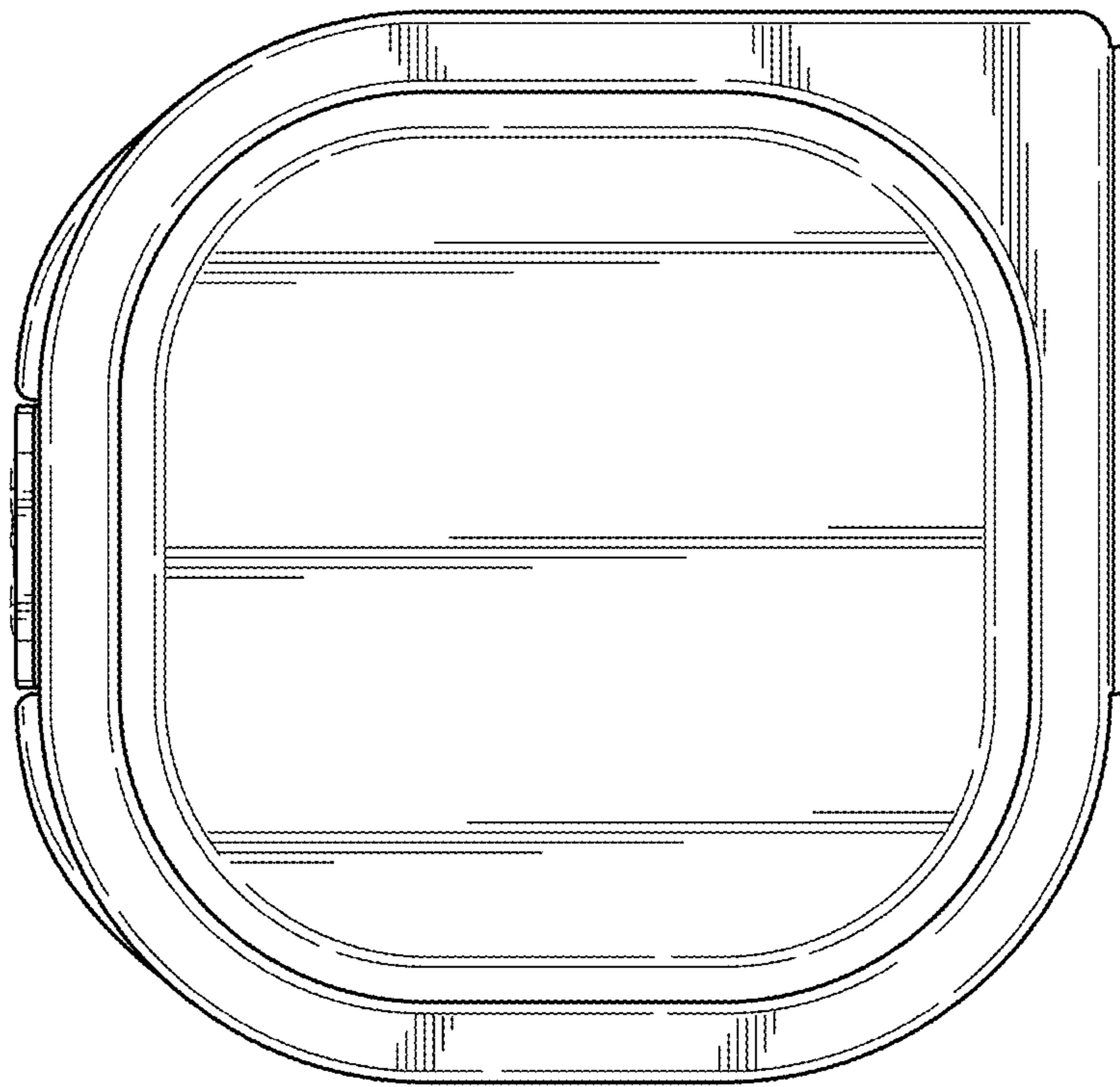

FIG. 3

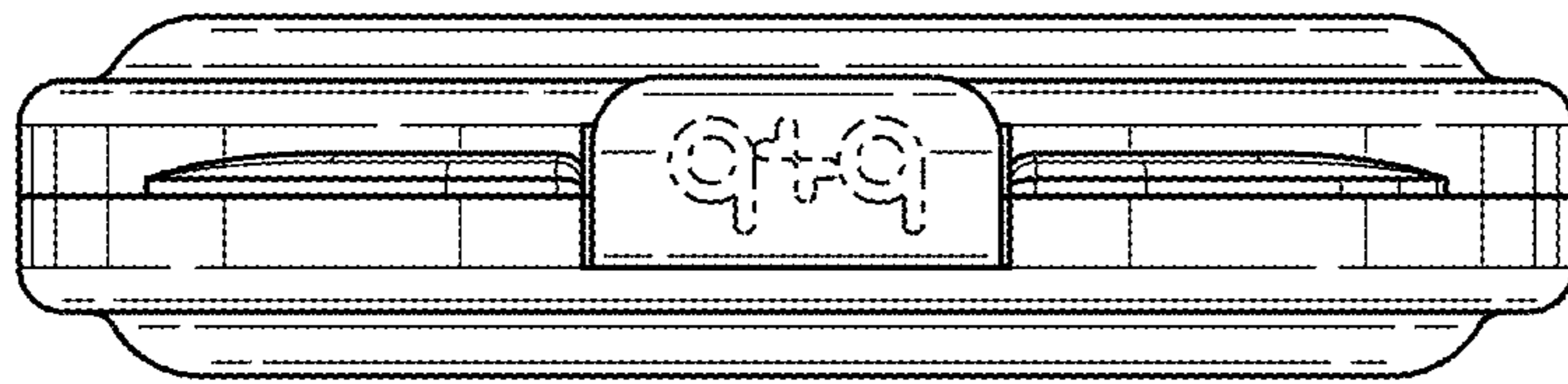

FIG. 5

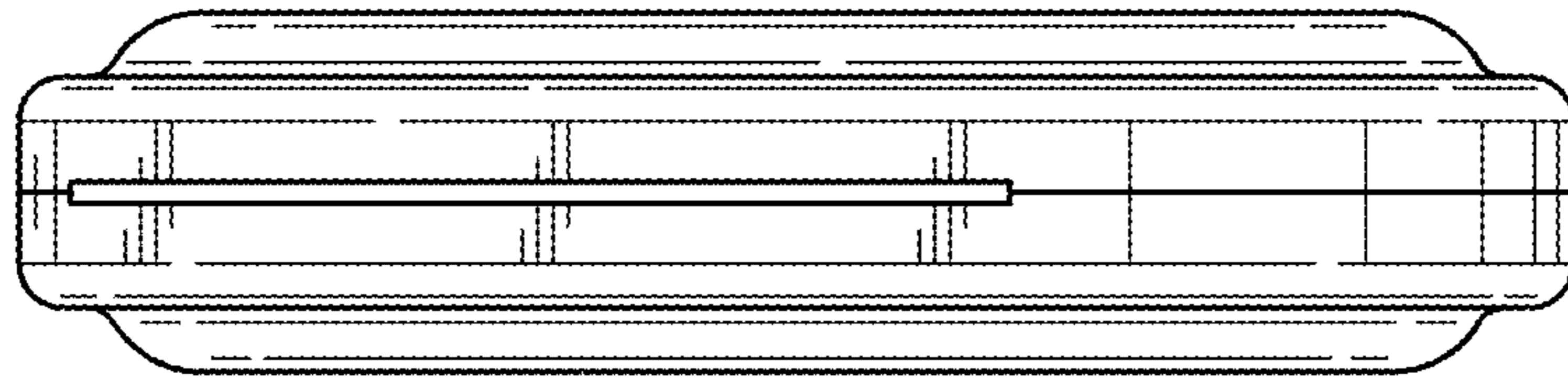

FIG. 4

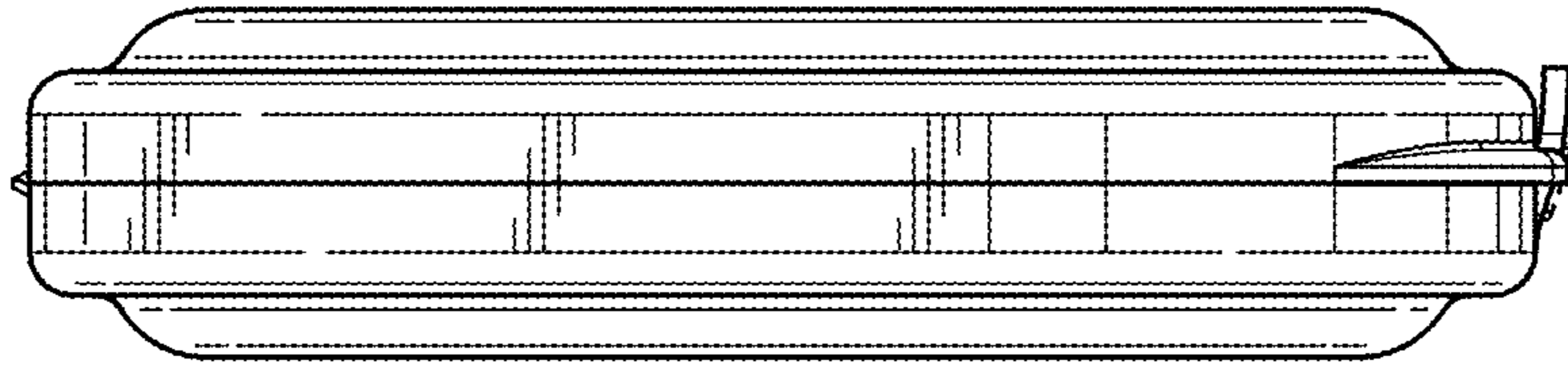

FIG. 6

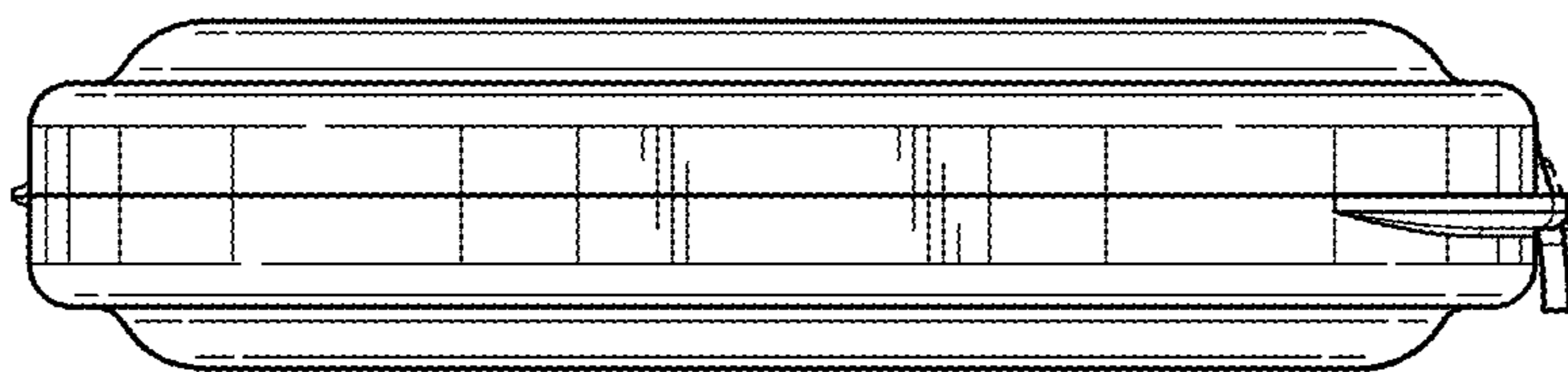

FIG. 7

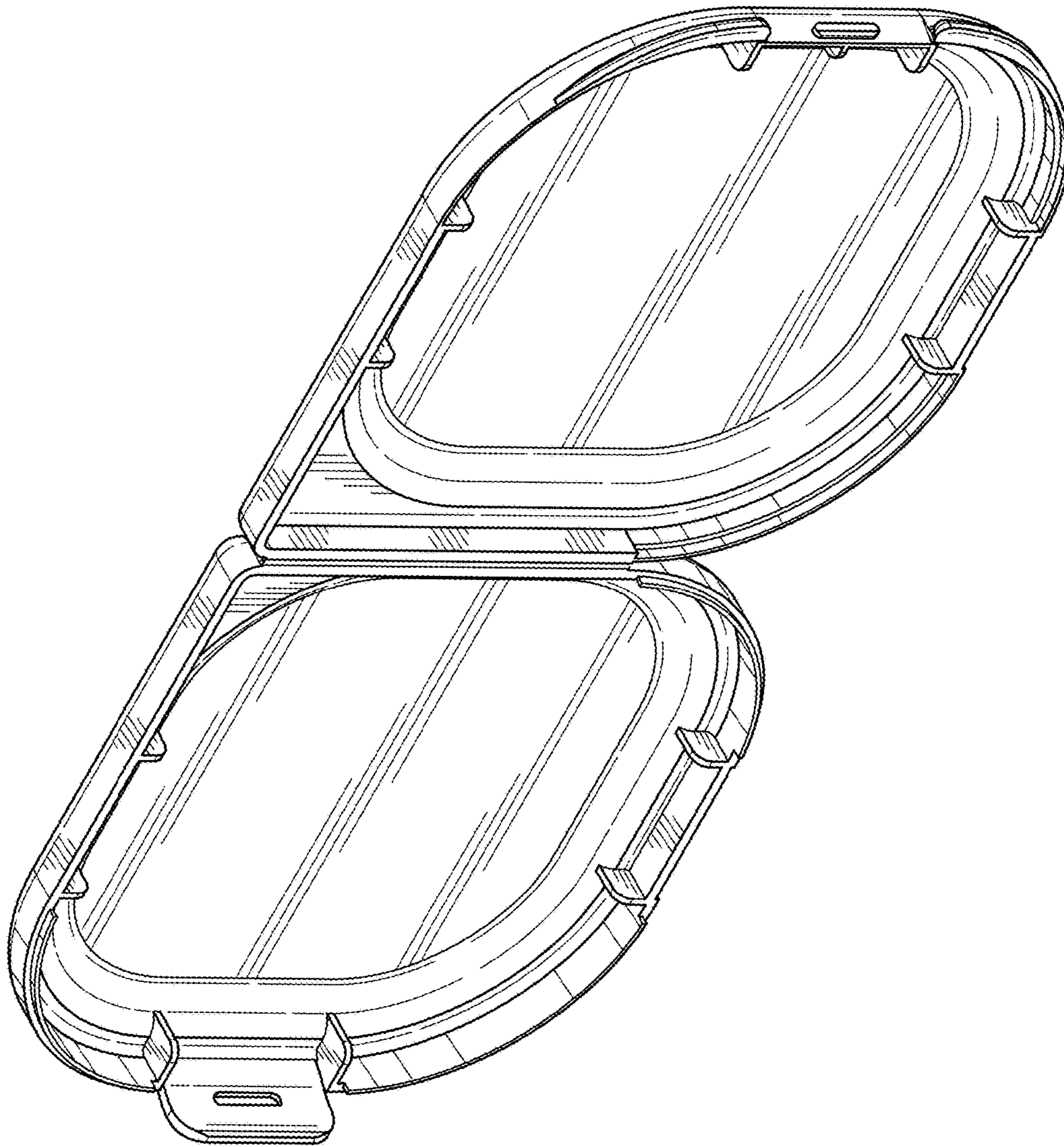

FIG. 8

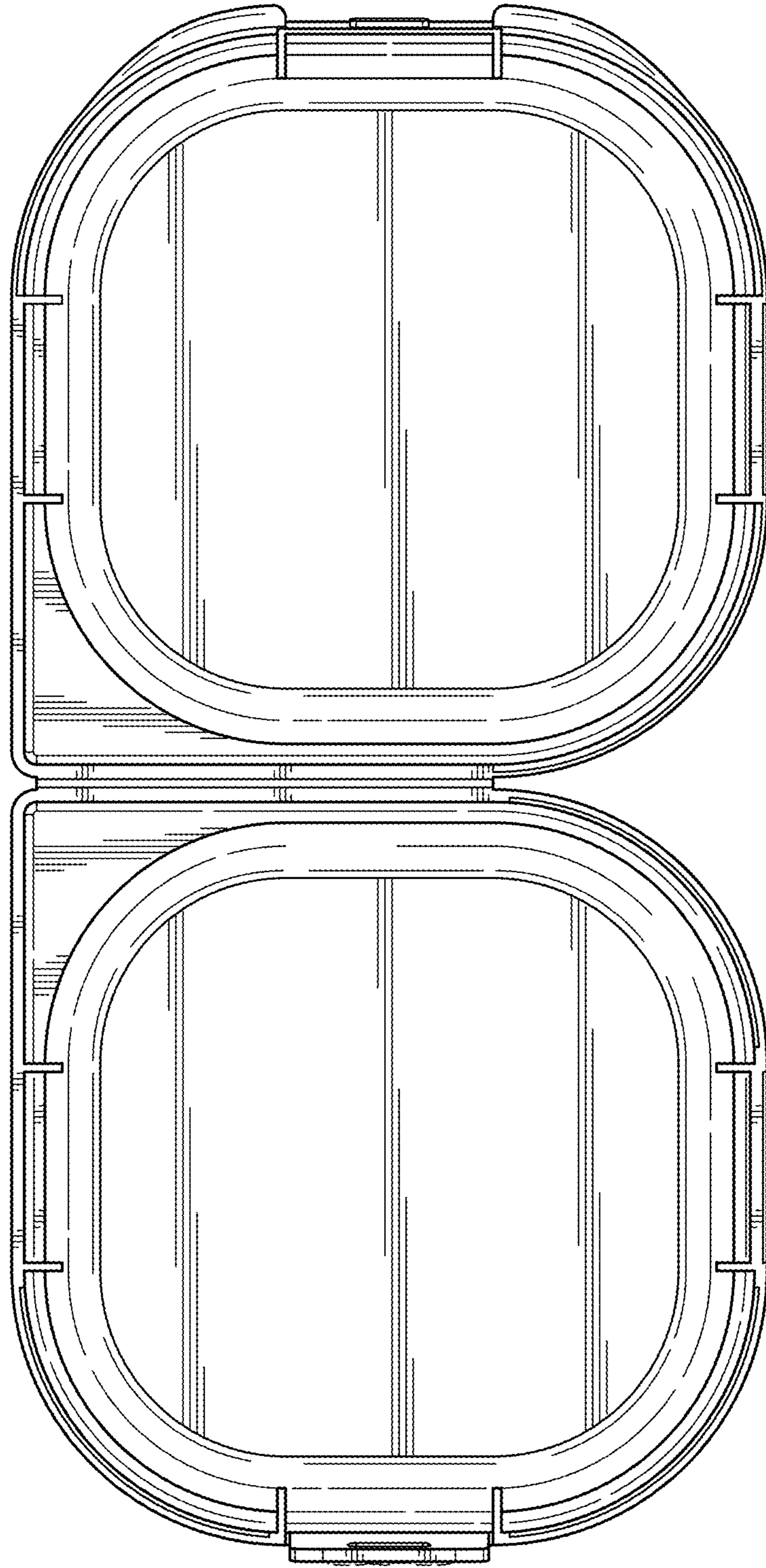

FIG. 9

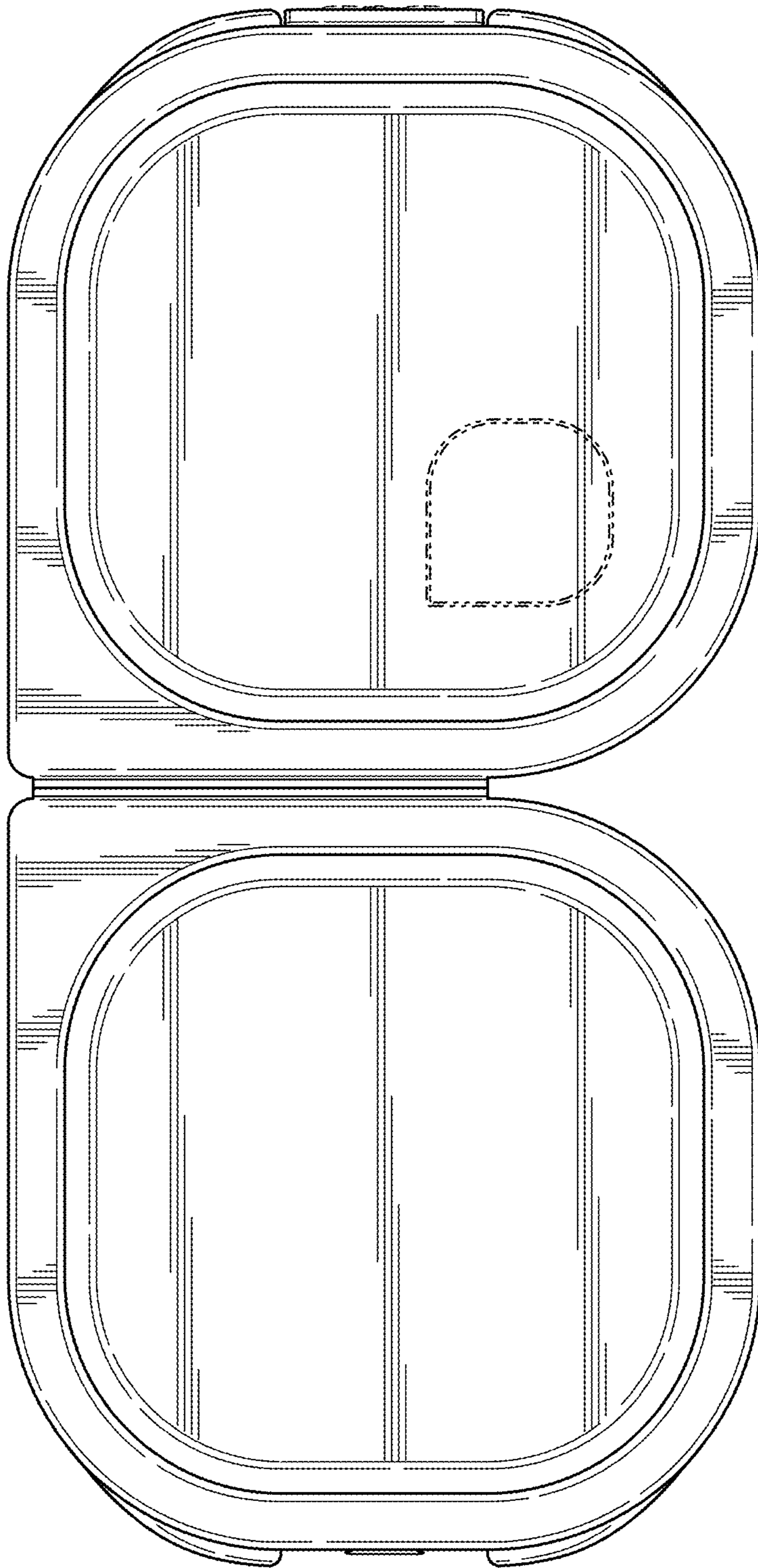

FIG. 10

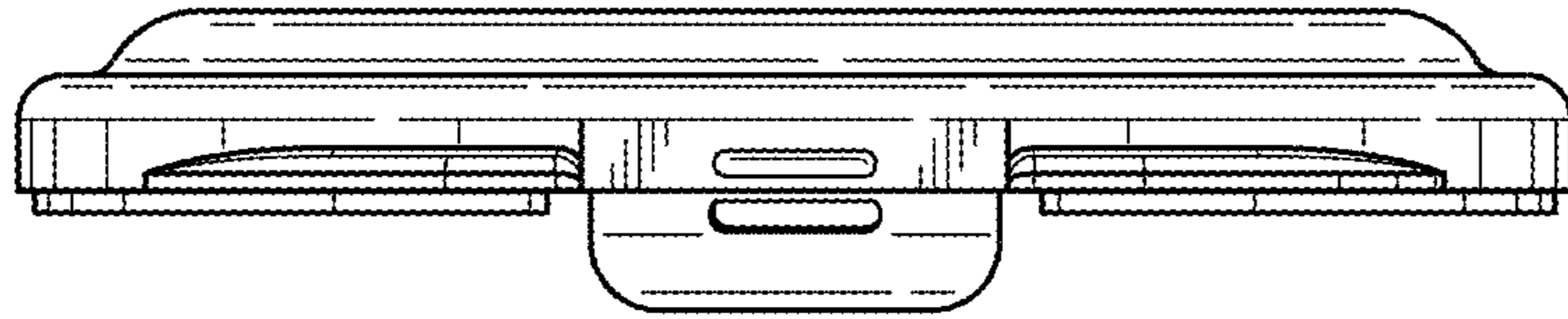

FIG. 12

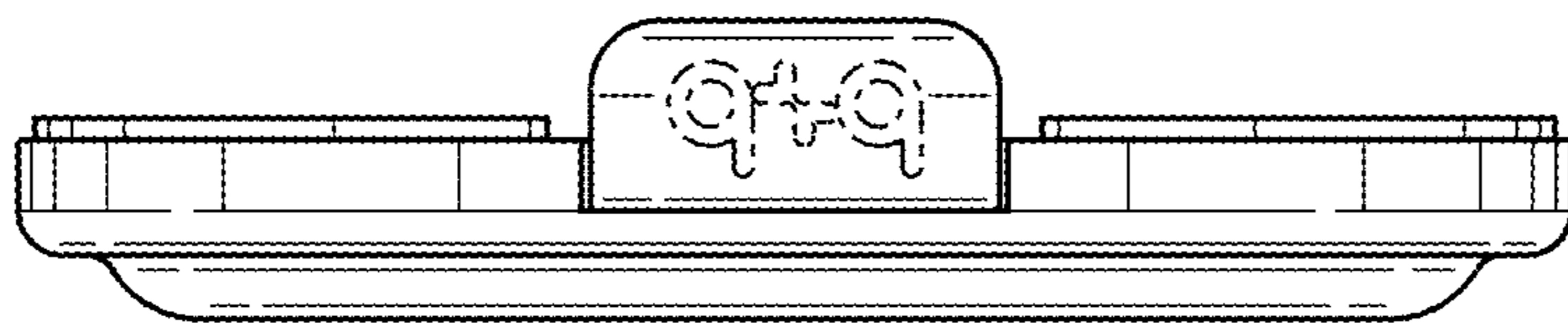

FIG. 11

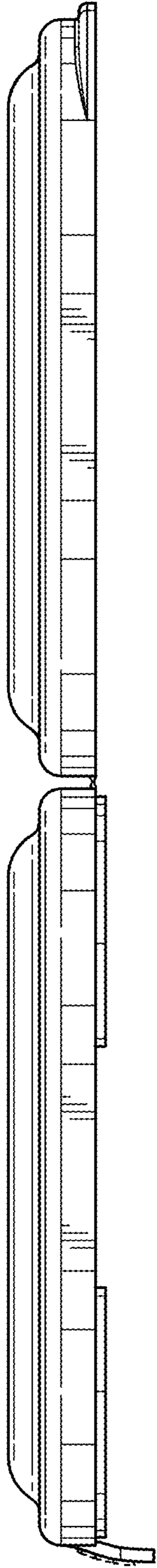

FIG. 13

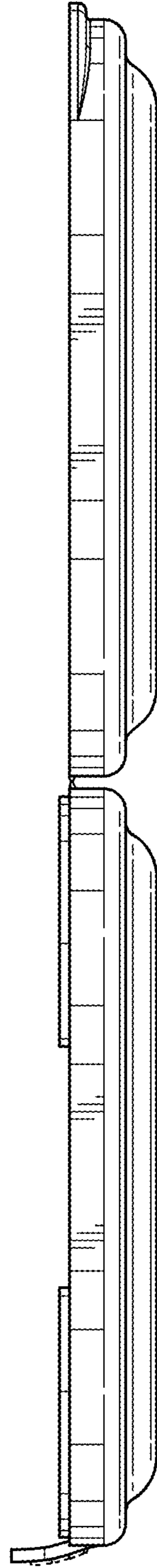

FIG. 14