



US00D805287S

(12) **United States Design Patent**
Savovici

(10) **Patent No.:** **US D805,287 S**

(45) **Date of Patent:** **** Dec. 19, 2017**

(54) **SHOE UPPER**

(71) Applicant: **NIKE, Inc.**, Beaverton, OR (US)

(72) Inventor: **Paul Savovici**, Portland, OR (US)

(73) Assignee: **NIKE, Inc.**, Beaverton, OR (US)

(**) Term: **15 Years**

(21) Appl. No.: **29/593,659**

(22) Filed: **Feb. 10, 2017**

(51) **LOC (10) Cl.** **02-99**

(52) **U.S. Cl.**
USPC **D2/972**

(58) **Field of Classification Search**
USPC D2/902, 906-908, 923, 944, 969,
D2/971-974; D5/47, 49, 54
CPC ... A43B 13/181; A43B 13/141; A43B 13/186;
A43B 13/188; A43B 23/00; A43B 23/02;
A43B 5/00; A43B 23/26; A43B 1/04;
A43B 11/14; A43B 7/00; A43B 3/12
See application file for complete search history.

(56) **References Cited**

U.S. PATENT DOCUMENTS

D347,314 S	5/1994	Uda	
D381,495 S *	7/1997	Avar	D2/972
D549,948 S *	9/2007	Hui	D2/972
D549,951 S *	9/2007	Mayden	D2/972
D554,845 S *	11/2007	Caine	D2/972
D563,665 S *	3/2008	Mayden	D2/972
D568,036 S *	5/2008	Caine	D2/972
D568,598 S *	5/2008	Caron	D2/972
D569,602 S *	5/2008	Caron	D2/969
D572,002 S *	7/2008	Alfaro	D2/972
D574,588 S	8/2008	Taylor	
D574,589 S	8/2008	Edwards et al.	
D694,506 S *	12/2013	Anceresi	D2/972

D718,033 S *	11/2014	Cin	D2/972
D740,539 S *	10/2015	Yun	D2/972
D756,101 S *	5/2016	Portzline	D2/973
D771,930 S *	11/2016	Kirschner	D2/973
D776,912 S	1/2017	Heinrich	

OTHER PUBLICATIONS

Jordan Brand Introduces the Westbrook 0 [online], [retrieved Dec. 8, 2016] retrieved from internet <URL: <http://news.nike.com/news/jordan-brand-introduces-the-westbrook-0/>; 25 color sheets, Dated Jul. 11, 2015.

Jordan Brand Launches the Westbrook 0.2 [online], [retrieved Dec. 8, 2016] retrieved from internet <URL: <http://news.nike.com/news/westbrook-0-2/>; 14 color sheets, Dated Oct. 14, 2016.

* cited by examiner

Primary Examiner — Dominic V Simone

(74) *Attorney, Agent, or Firm* — Banner & Witcoff, Ltd.

(57) **CLAIM**

The ornamental design for a shoe upper, as shown and described.

DESCRIPTION

FIG. 1 is a front perspective view of a shoe upper showing my new design;

FIG. 2 is a side view thereof;

FIG. 3 is a front view thereof;

FIG. 4 is a rear view thereof;

FIG. 5 is a top view thereof;

FIG. 6 is a bottom view thereof; and,

FIG. 7 is a rear perspective view thereof.

The broken lines immediately adjacent to the shaded area define the bounds of the claimed design and form no part thereof. The broken lines showing the remainder of the shoe represent unclaimed subject matter and form no part of the claimed design.

1 Claim, 7 Drawing Sheets

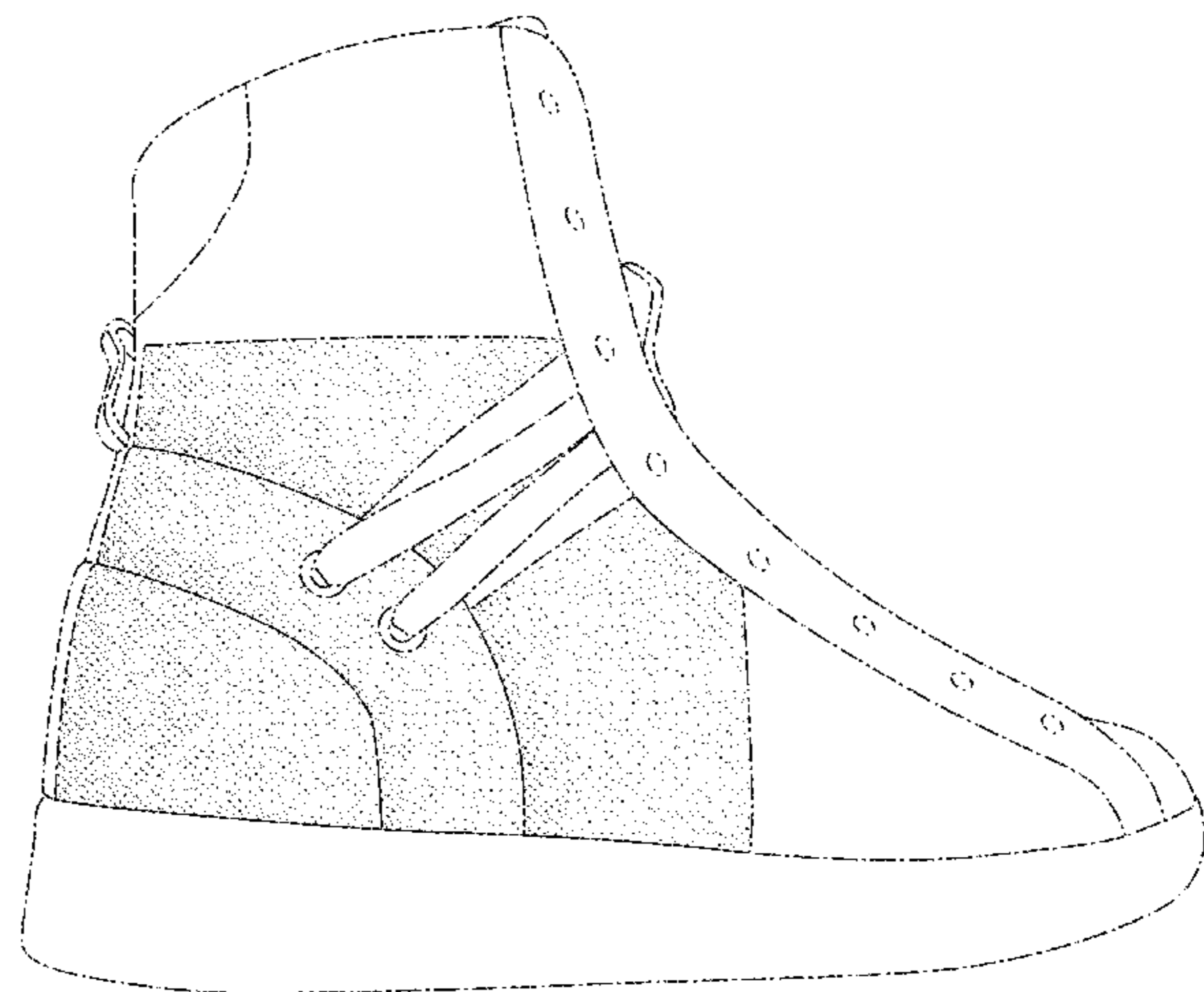
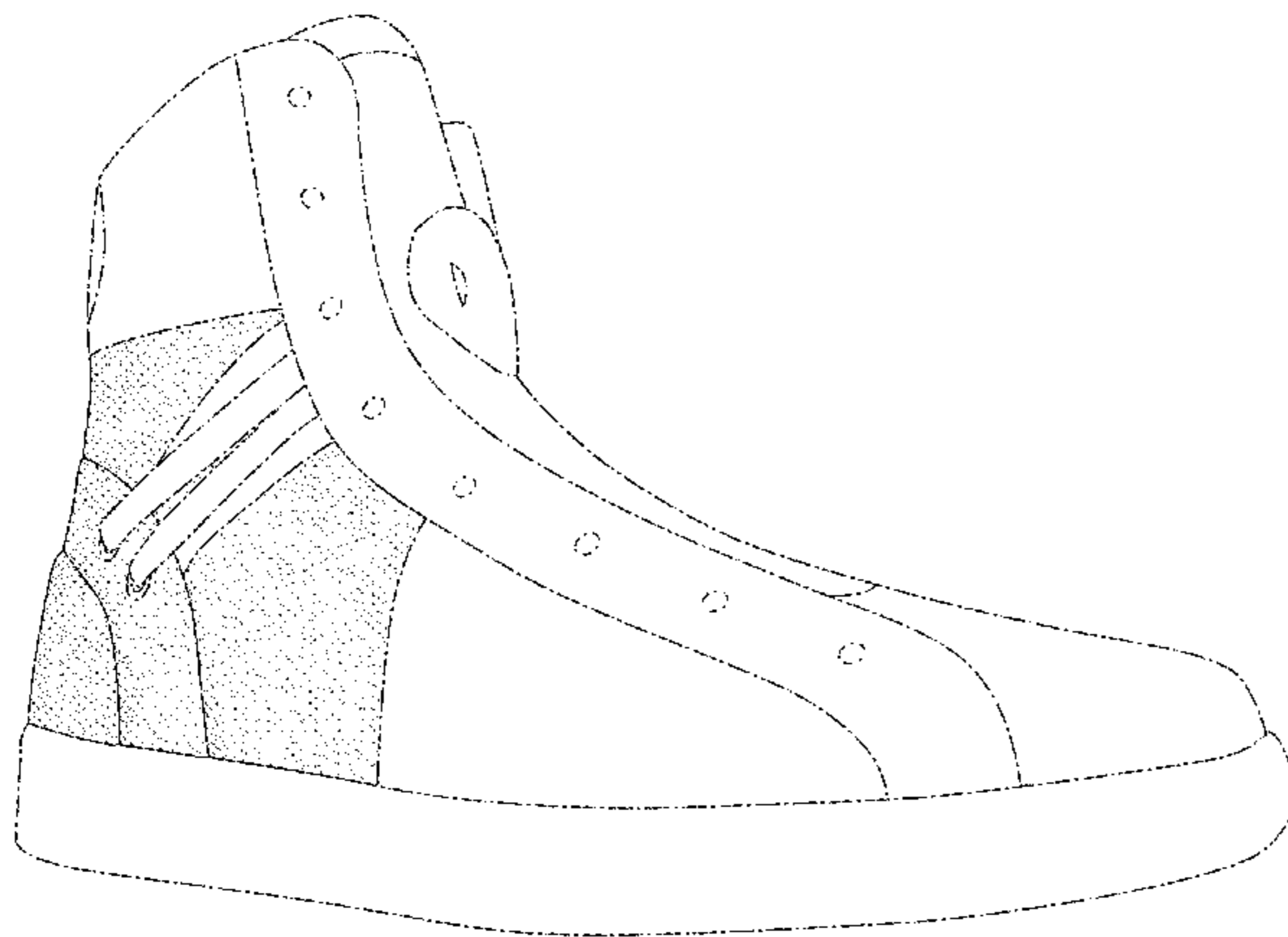

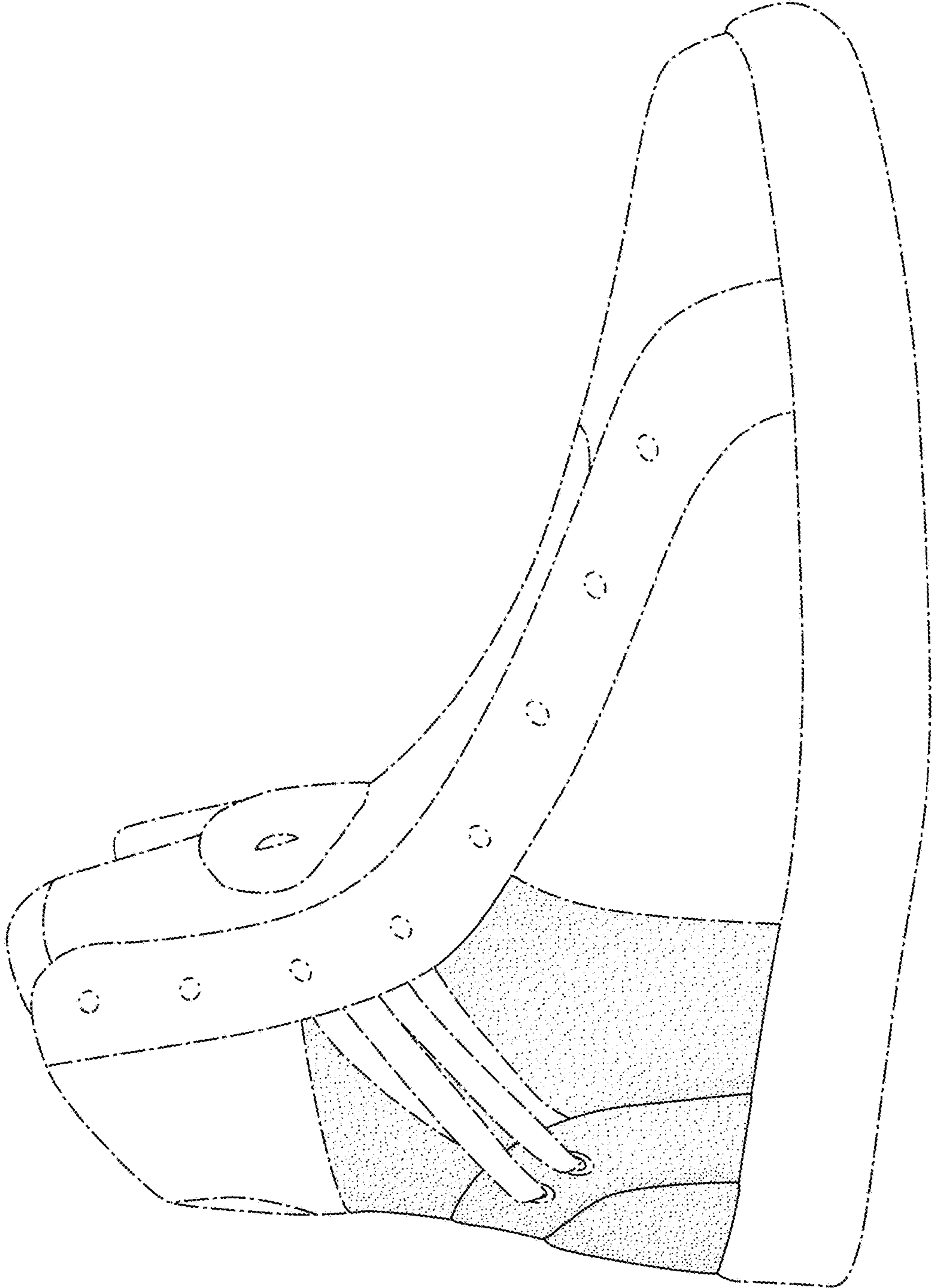
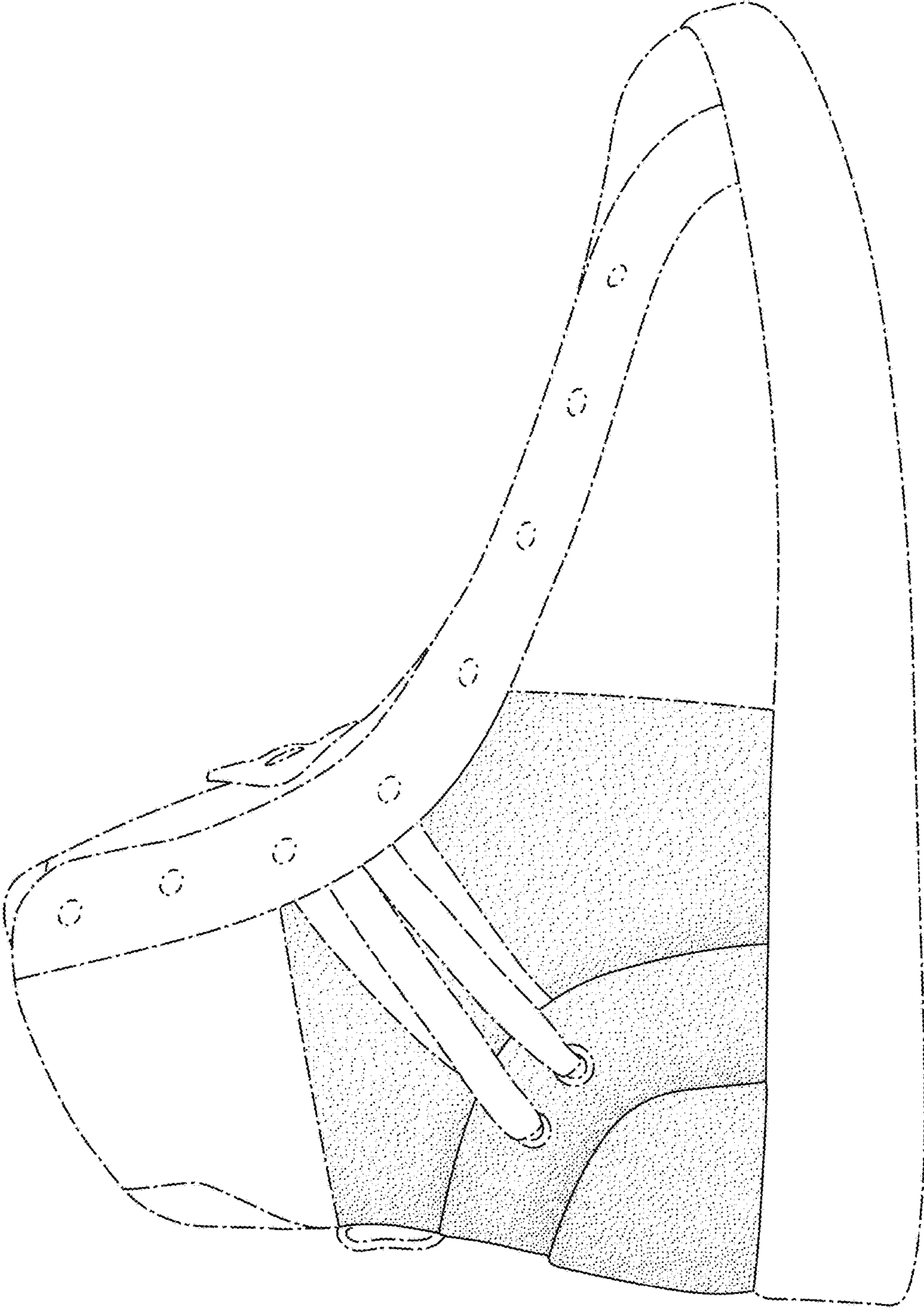

FIG. 1

FIG. 2



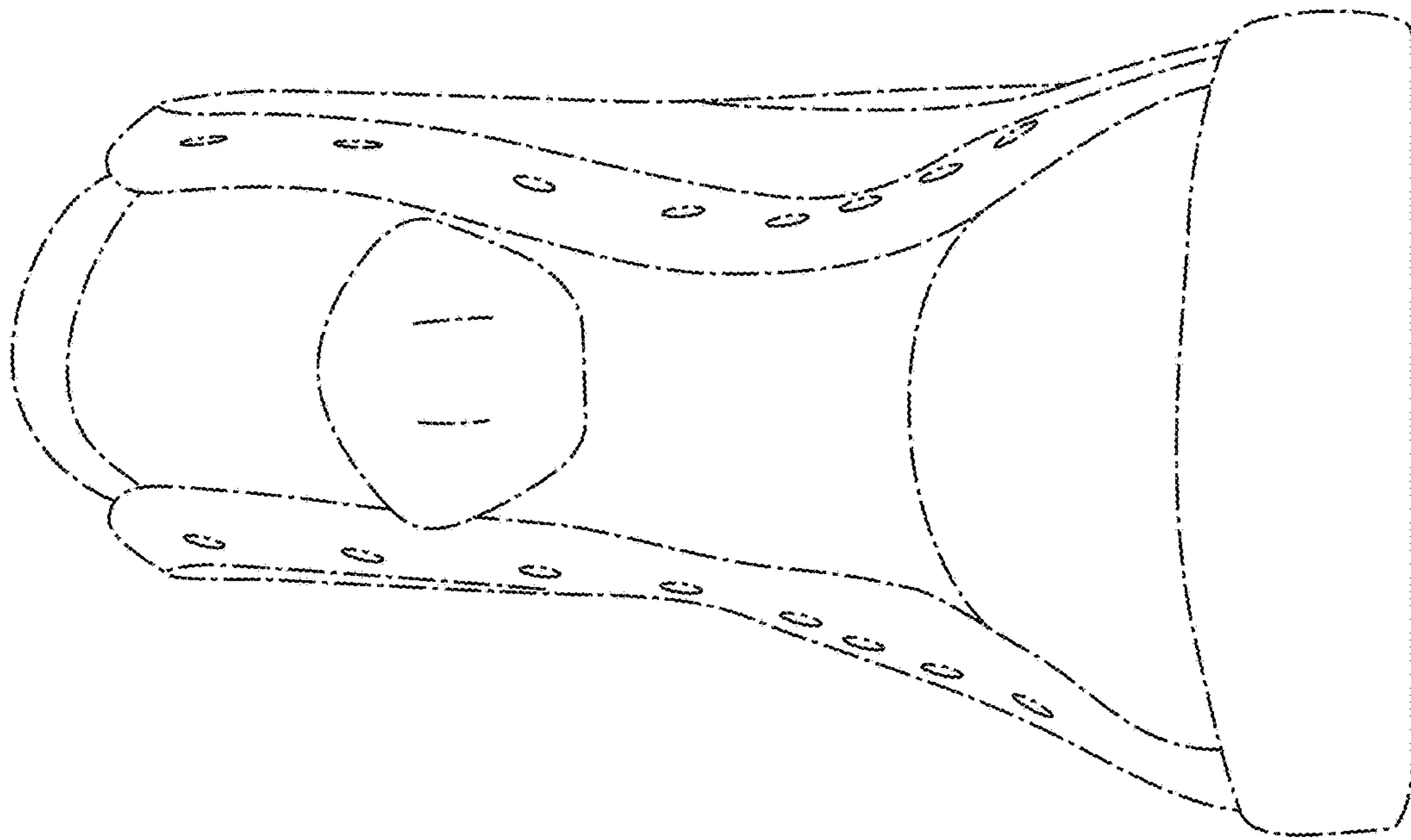

FIG. 3

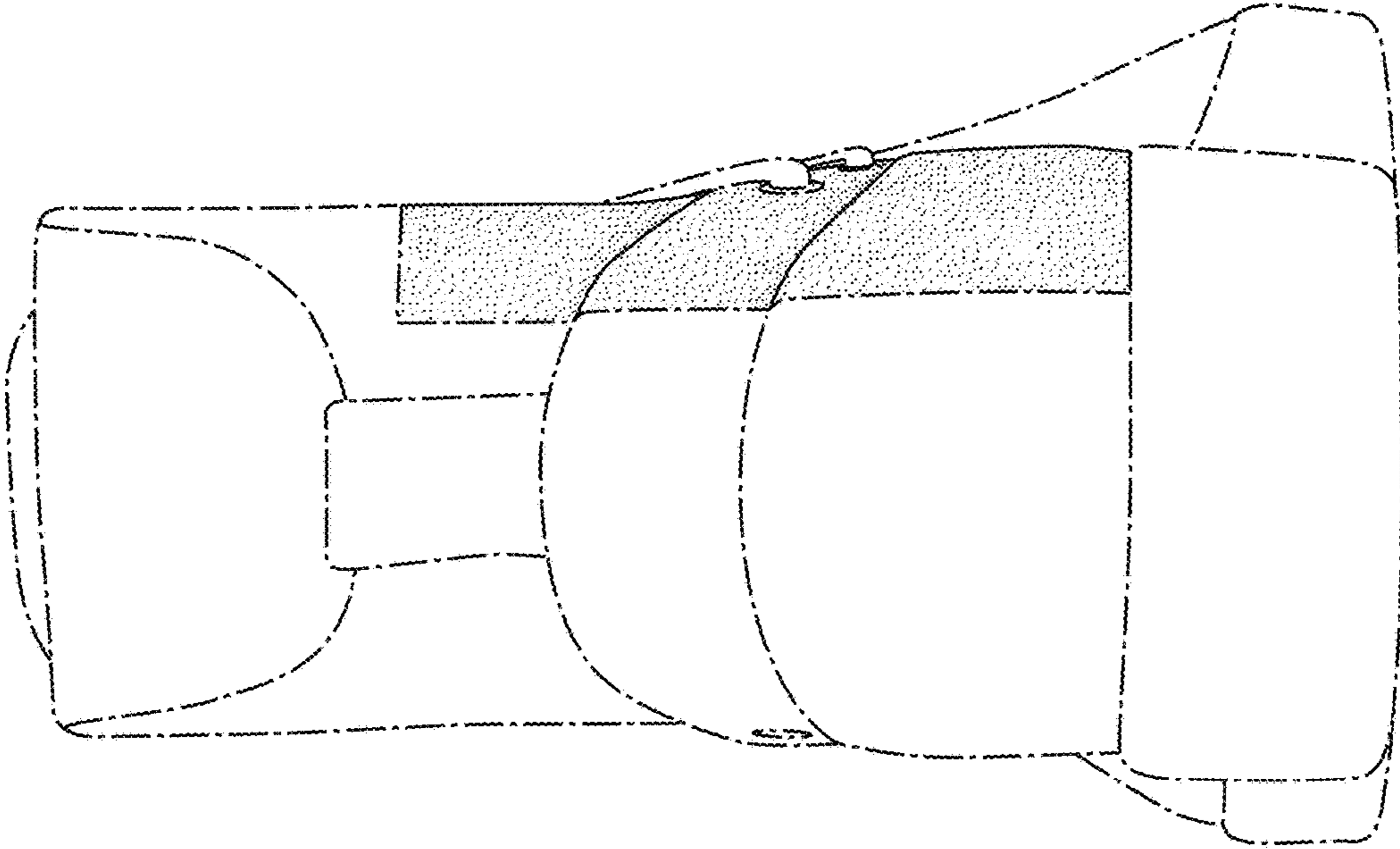

FIG. 4

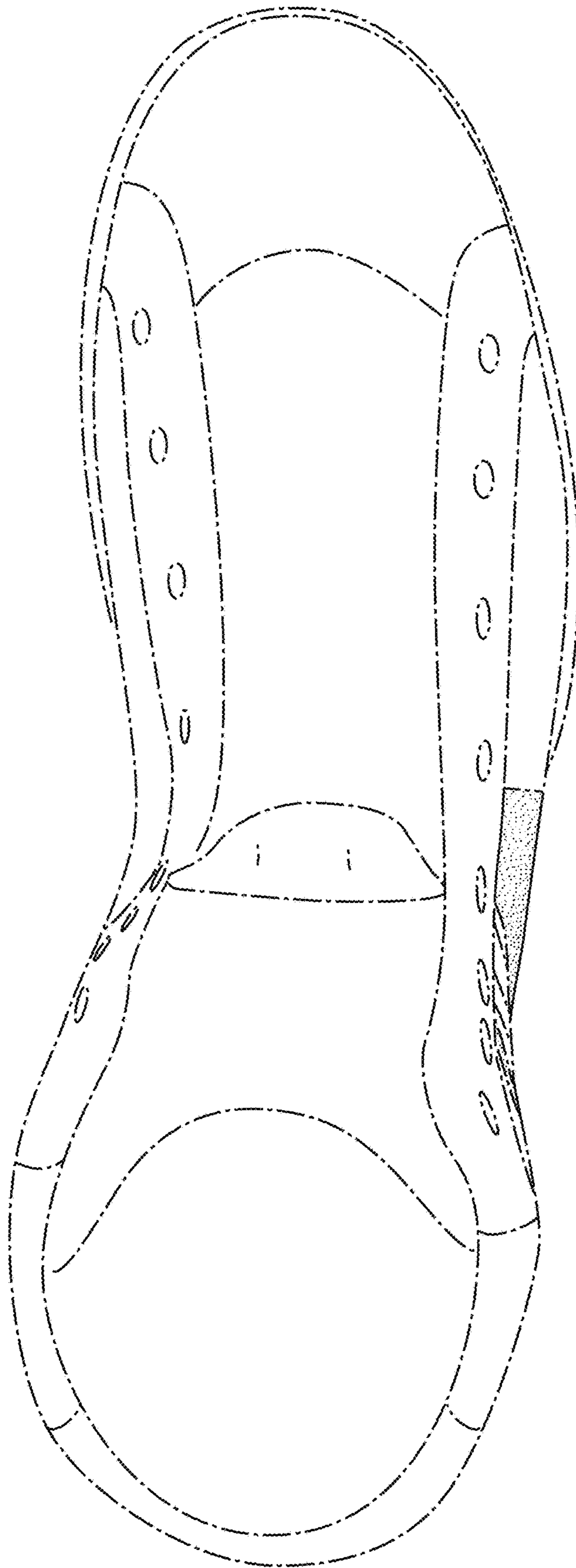

FIG. 5

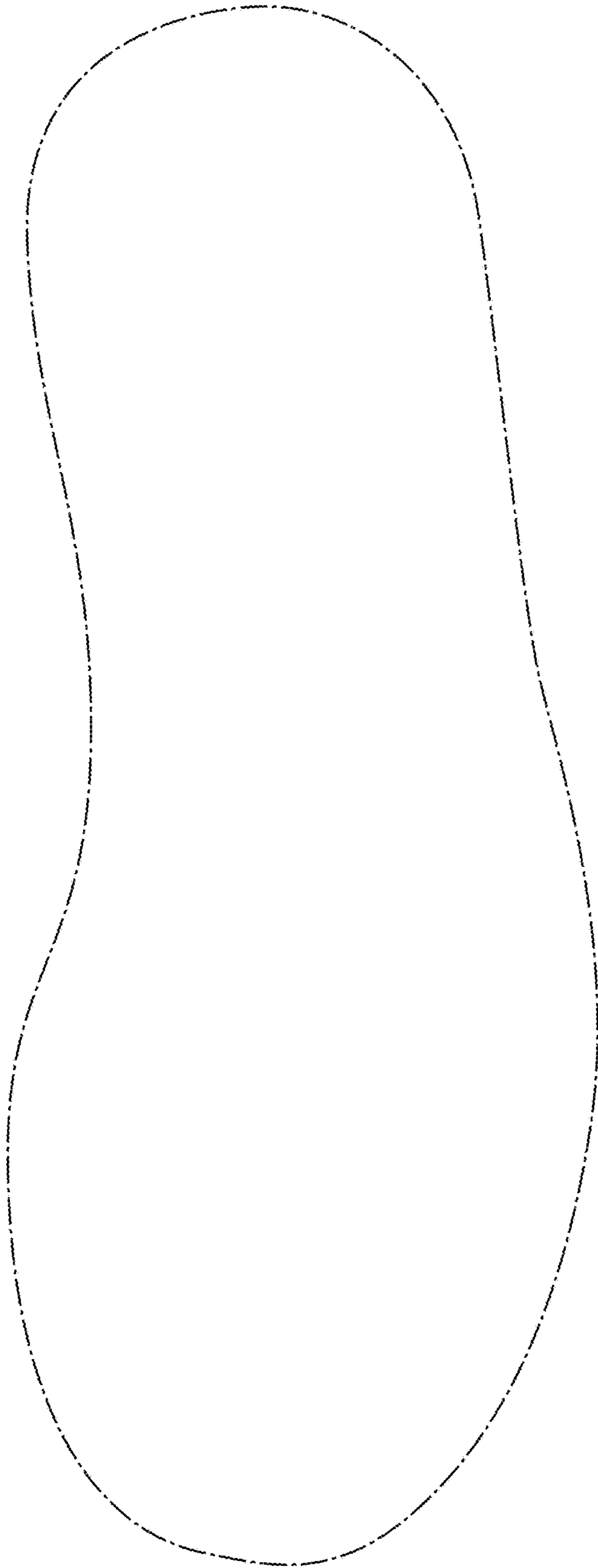

FIG. 6

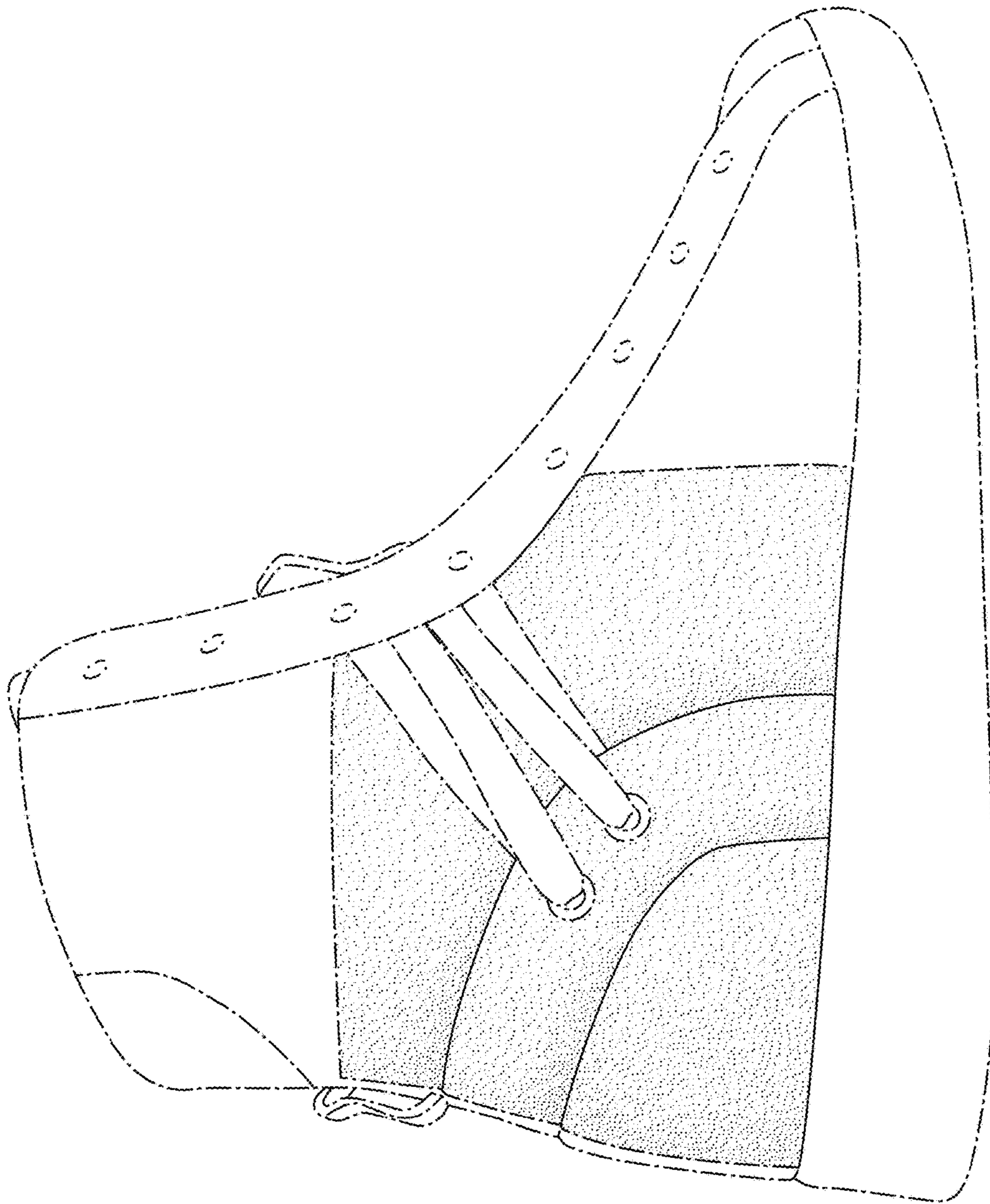

FIG. 7