



US00D805261S

(12) **United States Design Patent** (10) **Patent No.:** **US D805,261 S**  
**Yun** (45) **Date of Patent:** **\*\* Dec. 12, 2017**

(54) **DOG HARNESS**

(71) Applicant: **Yeu Hoon Yun**, Los Angeles, CA (US)

(72) Inventor: **Yeu Hoon Yun**, Los Angeles, CA (US)

(\*\*) Term: **15 Years**

(21) Appl. No.: **29/567,854**

(22) Filed: **Jun. 13, 2016**

(51) **LOC (10) Cl.** ..... **30-04**

(52) **U.S. Cl.**  
USPC ..... **D30/152**

(58) **Field of Classification Search**  
USPC ..... D30/136, 137, 138, 144, 145, 151, 152,  
D30/199; D2/627; D3/215, 327;  
D29/101.1, 101.3, 101.5; D24/190  
CPC ..... A01K 27/002  
See application file for complete search history.

(56) **References Cited**

**U.S. PATENT DOCUMENTS**

2,704,428	A *	3/1955	Sessler	.....	A01K 15/04 119/815
6,213,057	B1 *	4/2001	Franco	.....	A01K 27/002 119/793
D677,841	S *	3/2013	Gibbs	.....	D30/152
8,418,658	B1 *	4/2013	Remick	.....	A01K 27/002 119/792
D688,011	S *	8/2013	Gee	.....	D30/152
RE45,674	E *	9/2015	Evans	.....	D30/152
D753,350	S *	4/2016	Thitz	.....	D30/151
D760,448	S *	6/2016	Cecconato	.....	D30/152
D762,926	S *	8/2016	Ets-Hokin	.....	D30/152
2011/0067648	A1 *	3/2011	Siklosi	.....	A01K 27/002 119/792
2013/0128556	A1 *	5/2013	Brauser	.....	A01K 27/006 362/108
2016/0007570	A1 *	1/2016	Stout	.....	A01K 27/002 119/856
2016/0066544	A1 *	3/2016	Sporn	.....	A01K 27/002 119/863

**OTHER PUBLICATIONS**

“Gooby Easy Fit Padded Step in Dog Harness”. Found online Feb. 1, 2017 at amazon.com. Page dated Aug. 26, 2016. Retrieved from [https://www.amazon.com/Gooby-04602-BLU-S-Padded-Harness-Small/dp/B01H8IJUC0/ref=sr\\_1\\_17?s=pet-supplies&srs=7300723011&ie=UTF8&qid=1485983307&sr=1-17.\\*](https://www.amazon.com/Gooby-04602-BLU-S-Padded-Harness-Small/dp/B01H8IJUC0/ref=sr_1_17?s=pet-supplies&srs=7300723011&ie=UTF8&qid=1485983307&sr=1-17.*)  
“Gooby Jersey Harness”. Found online Feb. 1, 2017 at amazon.com. Page dated Feb. 11, 2013. Retrieved from [https://www.amazon.com/Gooby-Jersey-Harness-Small-Red/dp/B00CZ4T32A/ref=sr\\_1\\_21?s=pet-supplies&srs=7300723011&ie=UTF8&qid=1485983307&sr=1-21.\\*](https://www.amazon.com/Gooby-Jersey-Harness-Small-Red/dp/B00CZ4T32A/ref=sr_1_21?s=pet-supplies&srs=7300723011&ie=UTF8&qid=1485983307&sr=1-21.*)

(Continued)

*Primary Examiner* — Susan Bennett Hattan  
*Assistant Examiner* — Kendra L Hamilton  
(74) *Attorney, Agent, or Firm* — East West Law Group;  
Heedong Chae

(57) **CLAIM**

The ornamental design for a dog harness, as shown and described.

**DESCRIPTION**

FIG. 1 is a perspective view of a dog harness in use on a dog showing my new design;  
FIG. 2 is a perspective view thereof;  
FIG. 3 is another perspective view thereof;  
FIG. 4 is a front elevational view thereof;  
FIG. 5 is a rear elevational view thereof;  
FIG. 6 is a left side elevational view thereof;  
FIG. 7 is right side elevational view thereof;  
FIG. 8 is a top plan view thereof; and,  
FIG. 9 is a bottom plan view thereof.  
The broken line showing of a dog and harness hardware (buckles and rings) depicts environmental subject matter only and forms no part of the claimed design. The broken line showing on the harness depicts stitching and forms no part of the claimed design.

**1 Claim, 9 Drawing Sheets**

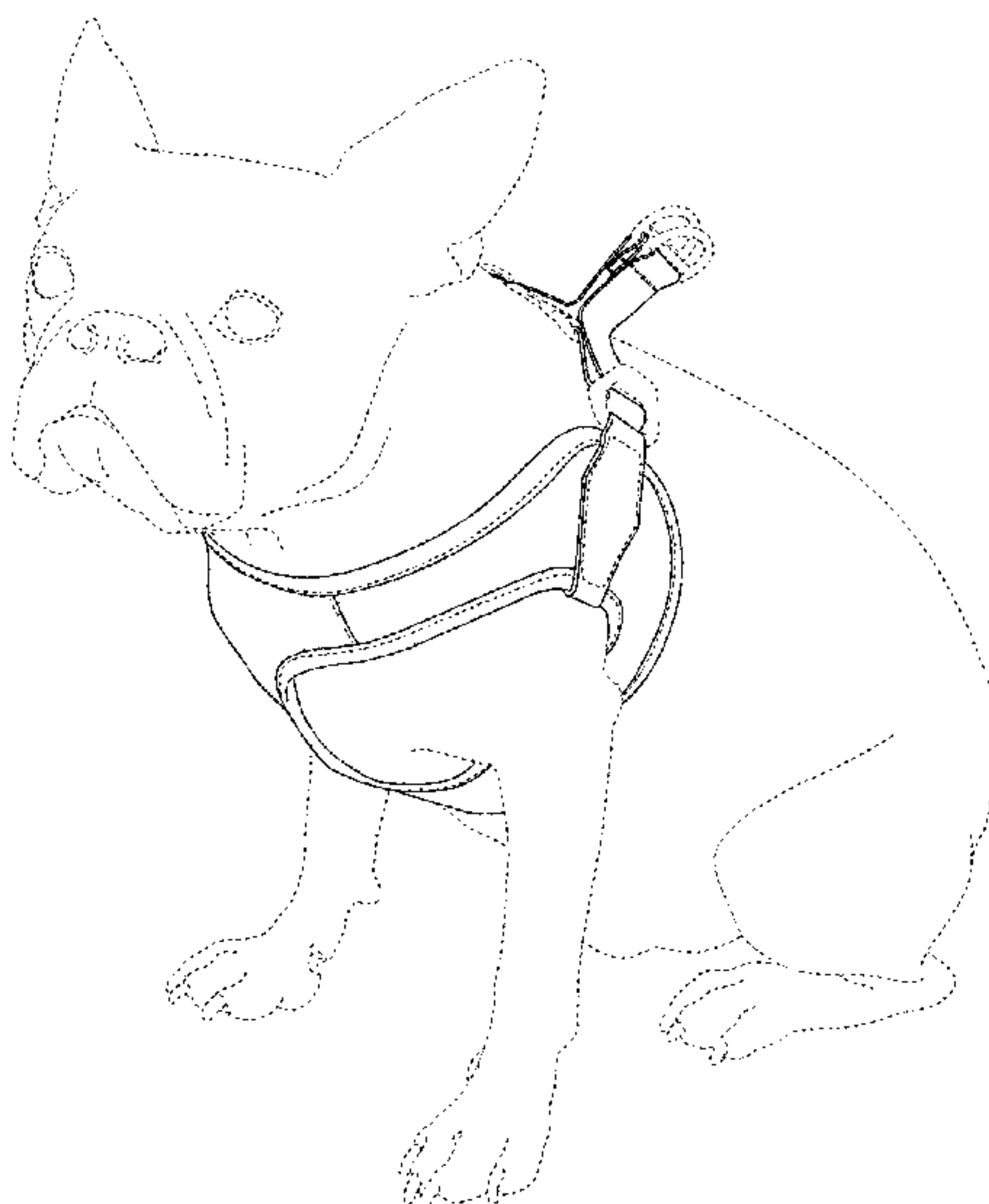

(56)

**References Cited**

OTHER PUBLICATIONS

“Gooby Trekking Memory Foam Harness & Comfort for Dogs”. Found online Feb. 1, 2017 at amazon.com. Page dated Jan. 27, 2016. Retrieved from [https://www.amazon.com/Gooby-Trekking-Harness-Comfort-X-Small/dp/B017Y0TIA6/ref=cm\\_cr\\_ar\\_p\\_d\\_product\\_top?ie=UTF8](https://www.amazon.com/Gooby-Trekking-Harness-Comfort-X-Small/dp/B017Y0TIA6/ref=cm_cr_ar_p_d_product_top?ie=UTF8).\*

“Buddy Belt Dog Harness”. Found online Jan. 30, 2017 at amazon.com. Page dated May 31, 2011. Retrieved from [https://www.amazon.com/Buddy-Belt-Dog-Harness-Red/dp/B001PMAJN0/ref=cm\\_cr\\_ar\\_p\\_d\\_product\\_top?ie=UTF8](https://www.amazon.com/Buddy-Belt-Dog-Harness-Red/dp/B001PMAJN0/ref=cm_cr_ar_p_d_product_top?ie=UTF8).\*

\* cited by examiner

FIG. 1

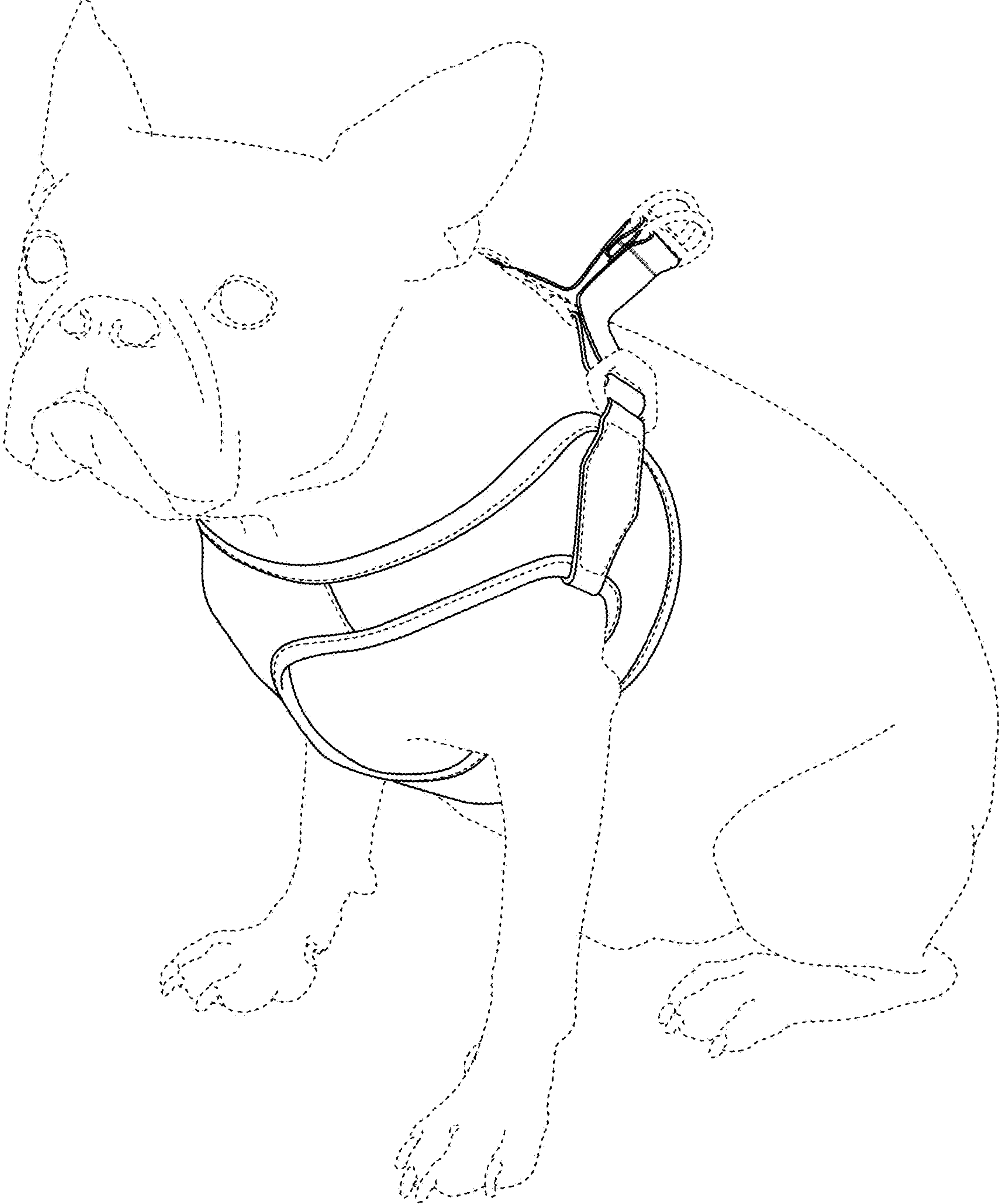

FIG. 2

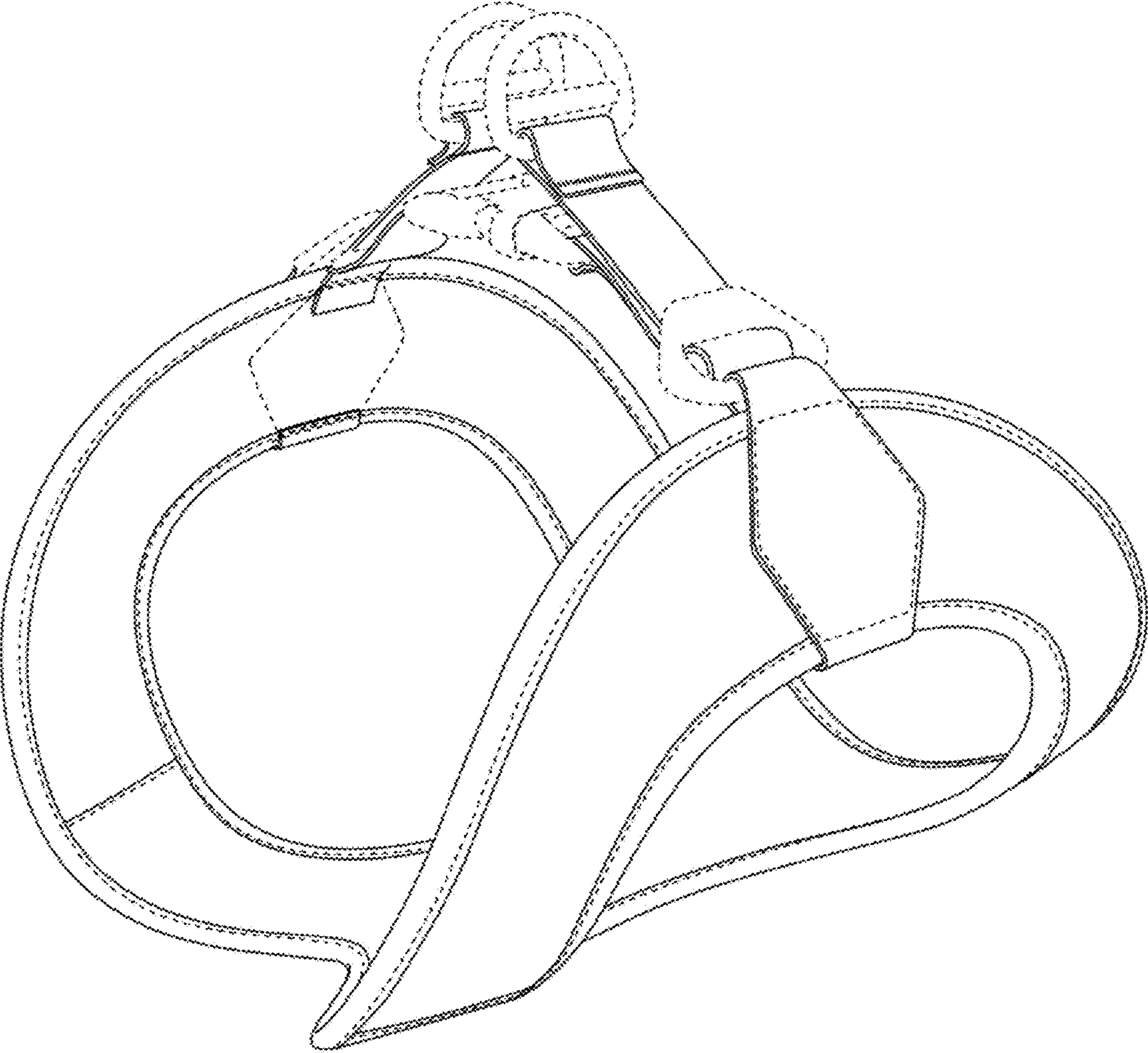



FIG. 3

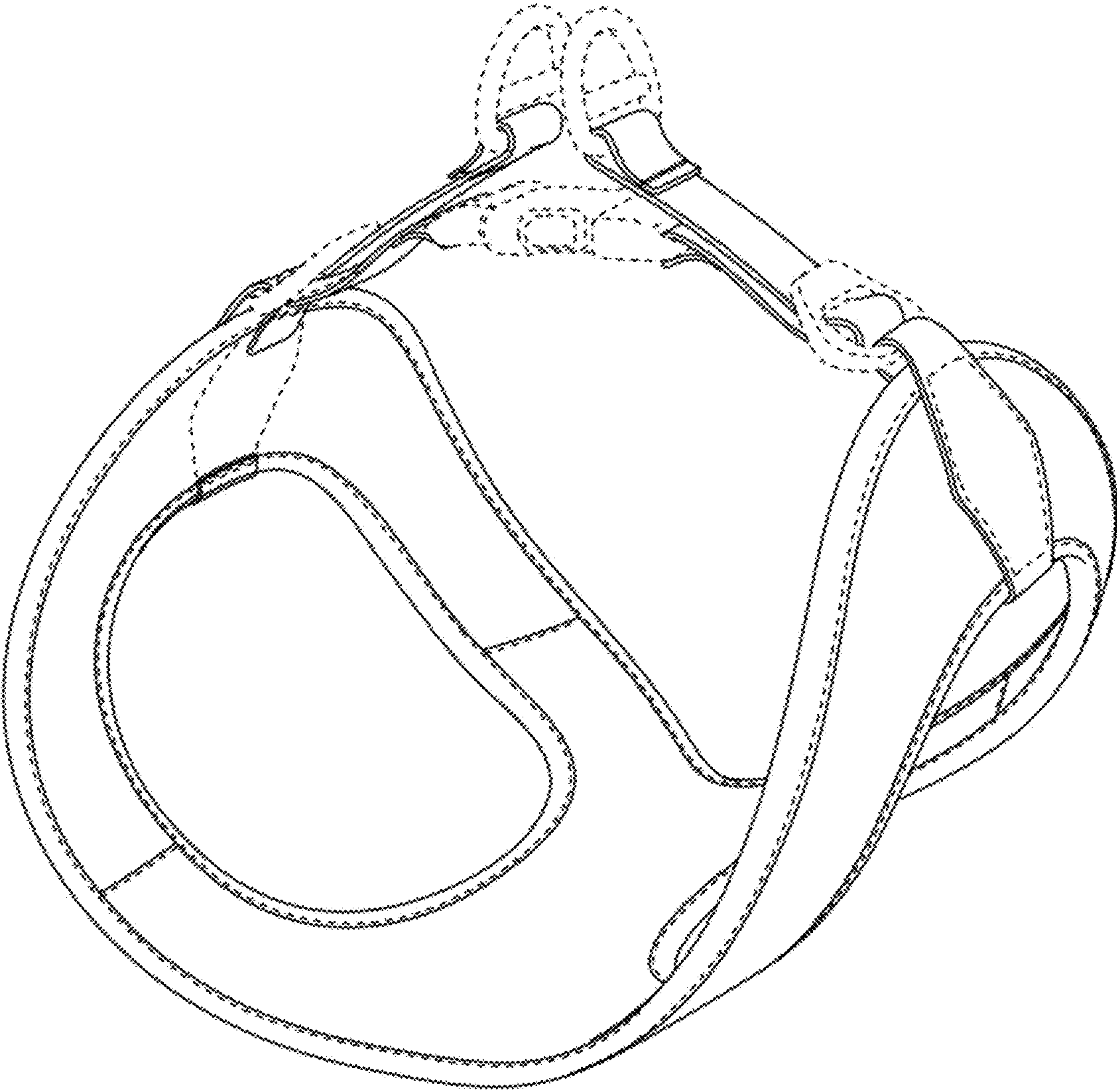

FIG. 4

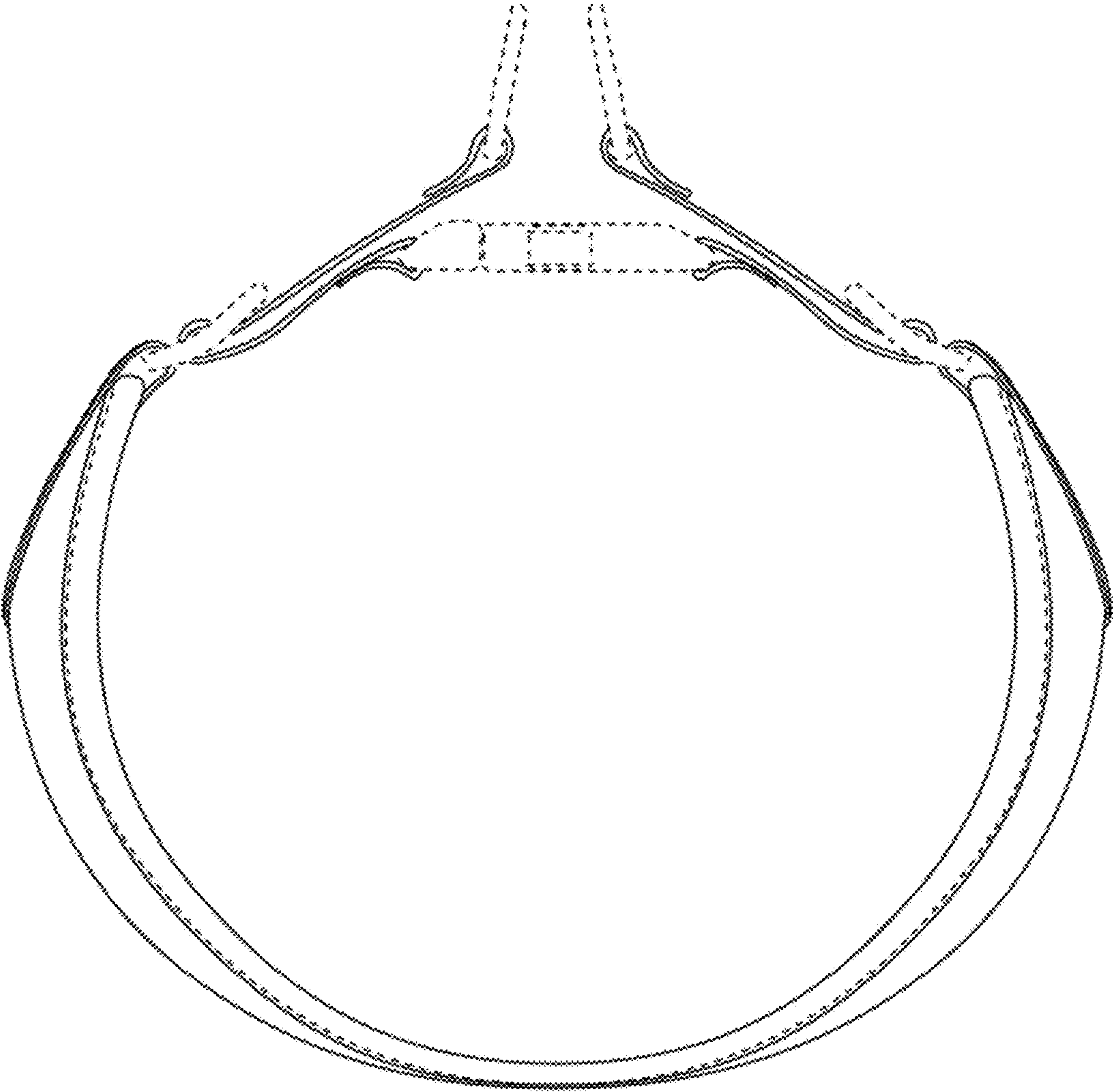

FIG. 5

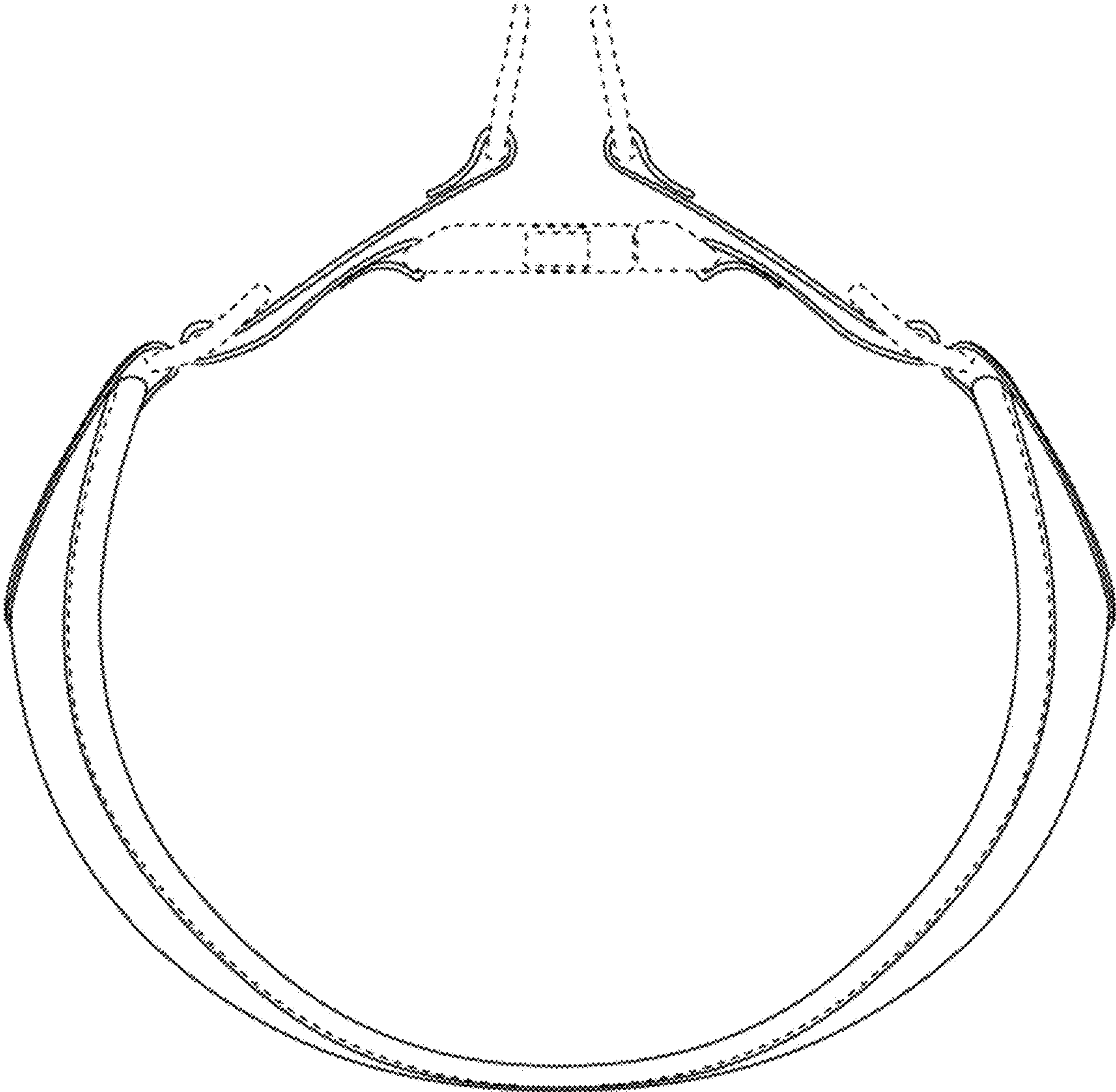

FIG. 6

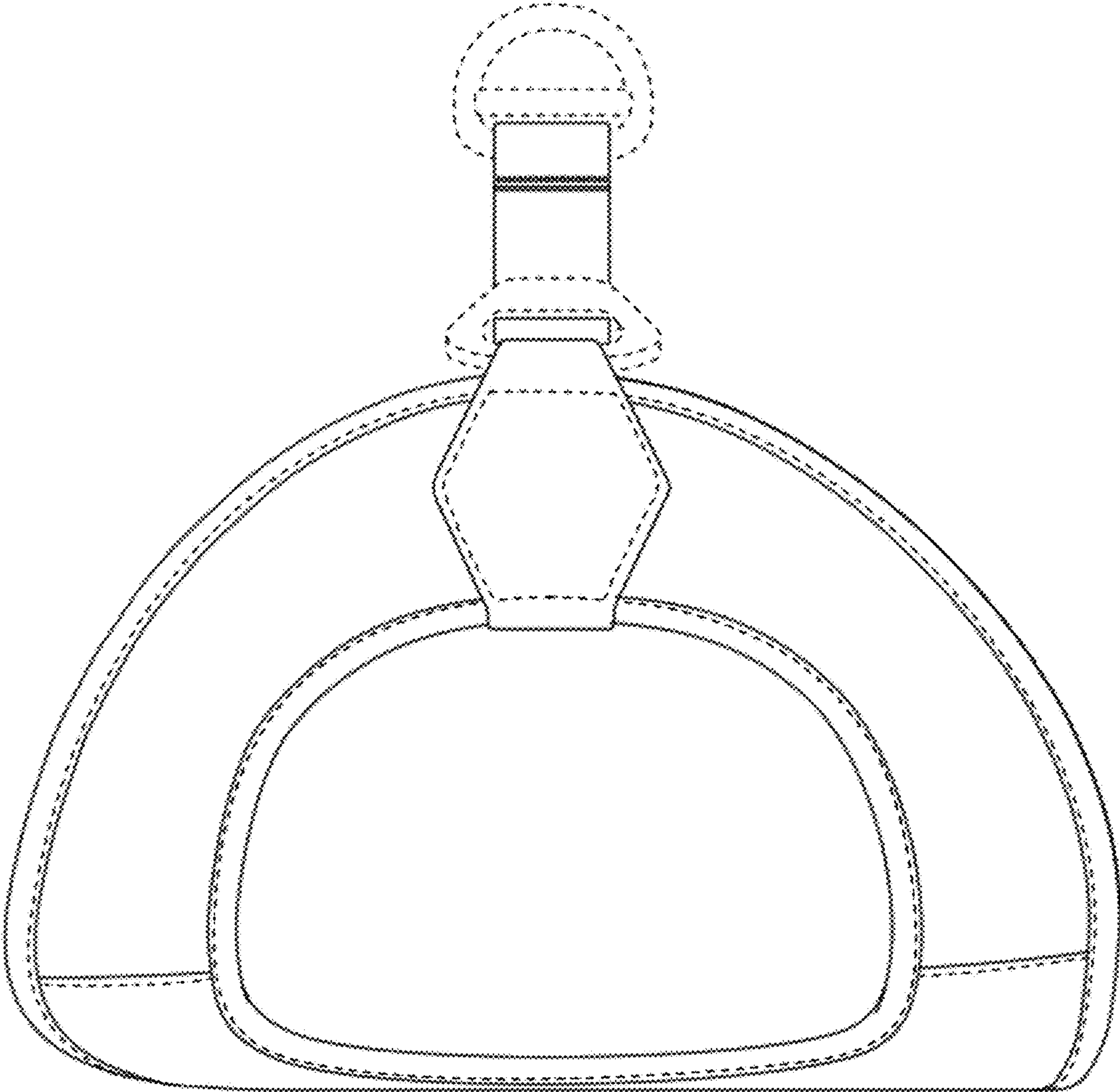



FIG. 7

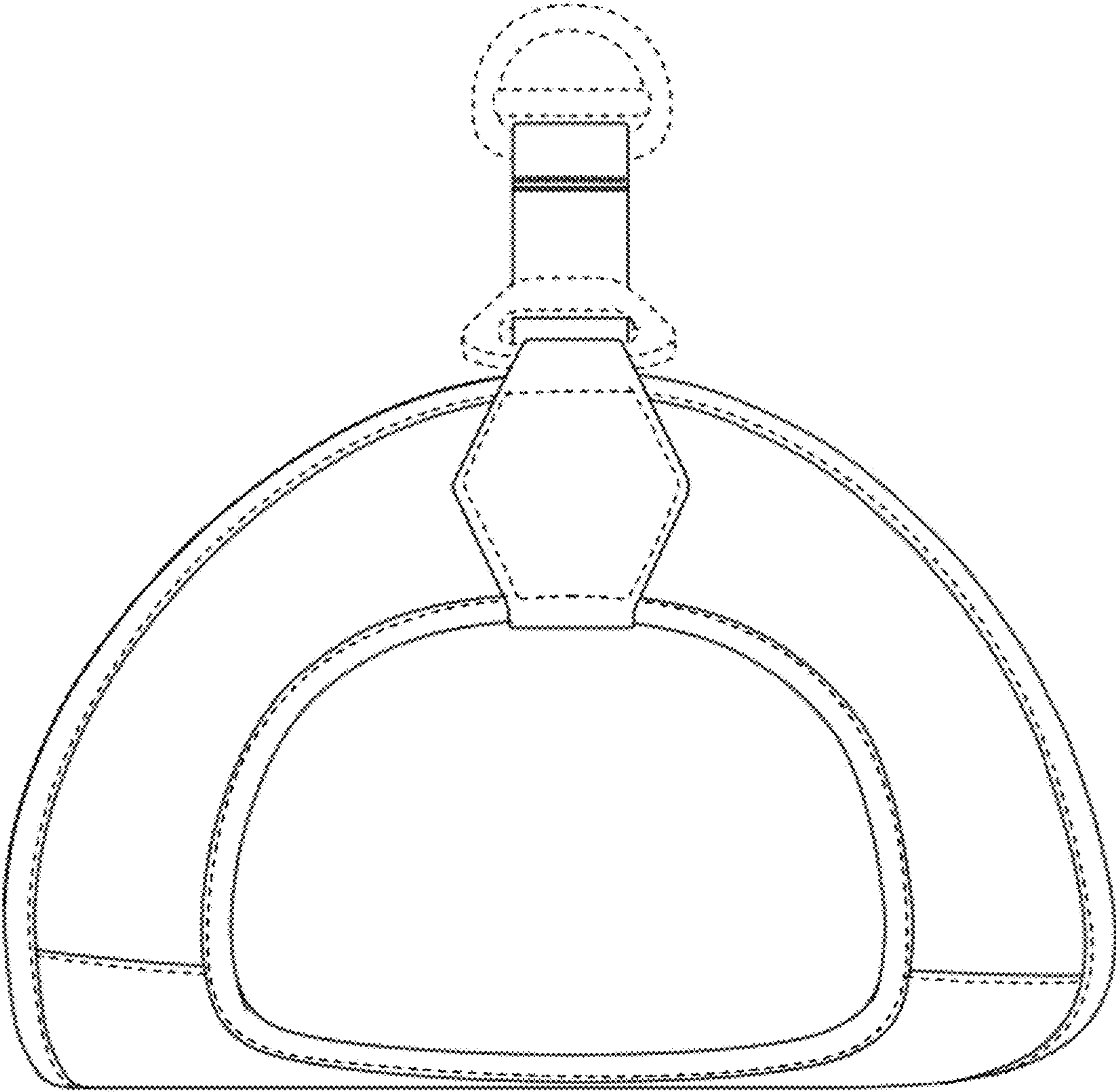

FIG. 8

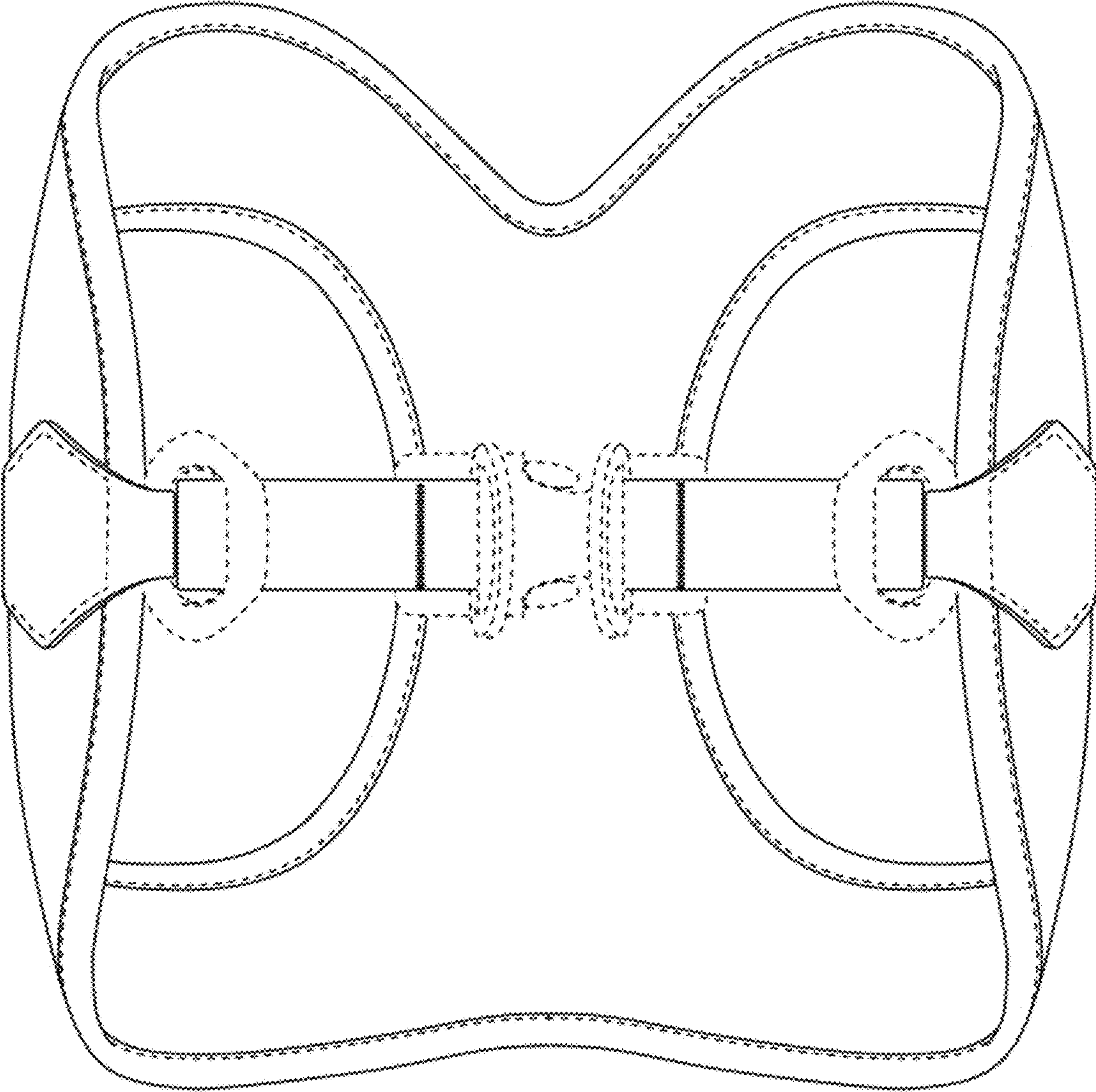

FIG. 9

