



US00D805155S

(12) **United States Design Patent**  
**Geissele**

(10) **Patent No.:** **US D805,155 S**

(45) **Date of Patent:** **\*\* Dec. 12, 2017**

(54) **BOLT CATCH FOR A FIREARM**  
(71) Applicant: **WHG Properties, LLC**, North Wales, PA (US)  
(72) Inventor: **William H. Geissele**, Lower Gwynedd, PA (US)

(73) Assignee: **WHG Properties, LLC**, North Wales, PA (US)

(\*\*) Term: **15 Years**

(21) Appl. No.: **29/563,330**

(22) Filed: **May 4, 2016**

(51) **LOC (10) Cl.** ..... **22-01**

(52) **U.S. Cl.**  
USPC ..... **D22/108**

(58) **Field of Classification Search**  
USPC ..... D22/108; D14/418  
CPC ..... F41C 23/00; F41C 27/00; F41C 27/06;  
F41C 23/10; F41C 23/14; F41C 23/16;  
F41C 23/18; F41A 5/18; F41A 5/24;  
F41A 21/28  
See application file for complete search history.

(56) **References Cited**

**U.S. PATENT DOCUMENTS**

8,327,749 B2 \* 12/2012 Underwood ..... F41A 9/59  
42/18  
8,359,966 B1 \* 1/2013 Brotherton ..... F41A 3/68  
42/70.02  
8,984,786 B2 \* 3/2015 Underwood ..... F41A 9/59  
42/18

9,429,375 B2 \* 8/2016 DeSomma ..... F41A 3/66  
D770,589 S \* 11/2016 Underwood ..... F41A 9/59  
D22/108  
9,541,339 B2 \* 1/2017 Orne, III ..... F41A 3/72  
9,551,545 B1 \* 1/2017 Rowe ..... F41A 19/06  
D784,478 S \* 4/2017 Therrell ..... D22/108  
9,651,328 B1 \* 5/2017 Oglesby ..... F41A 17/42

\* cited by examiner

*Primary Examiner* — Michael A Pratt

(74) *Attorney, Agent, or Firm* — Merchant & Gould, P.C.

(57) **CLAIM**

The ornamental design for a bolt catch for a firearm, as shown and described.

**DESCRIPTION**

FIG. 1 is a top, front, right side perspective view of a bolt catch for a firearm in accordance with the present disclosure; FIG. 2 is a top, front, left side perspective view of the bolt catch for a firearm of FIG. 1; FIG. 3 is a front view of the bolt catch for a firearm of FIG. 1; FIG. 4 is a rear view of the bolt catch for a firearm of FIG. 1; FIG. 5 is a right side view of the bolt catch for a firearm of FIG. 1; FIG. 6 is a left side view of the bolt catch for a firearm of FIG. 1; FIG. 7 is a top view of the bolt catch for a firearm of FIG. 1; and, FIG. 8 is a bottom view of the bolt catch for a firearm of FIG. 1.

The broken lines in the Figures are for illustrative purposes only and form no part of the claimed design.

**1 Claim, 4 Drawing Sheets**

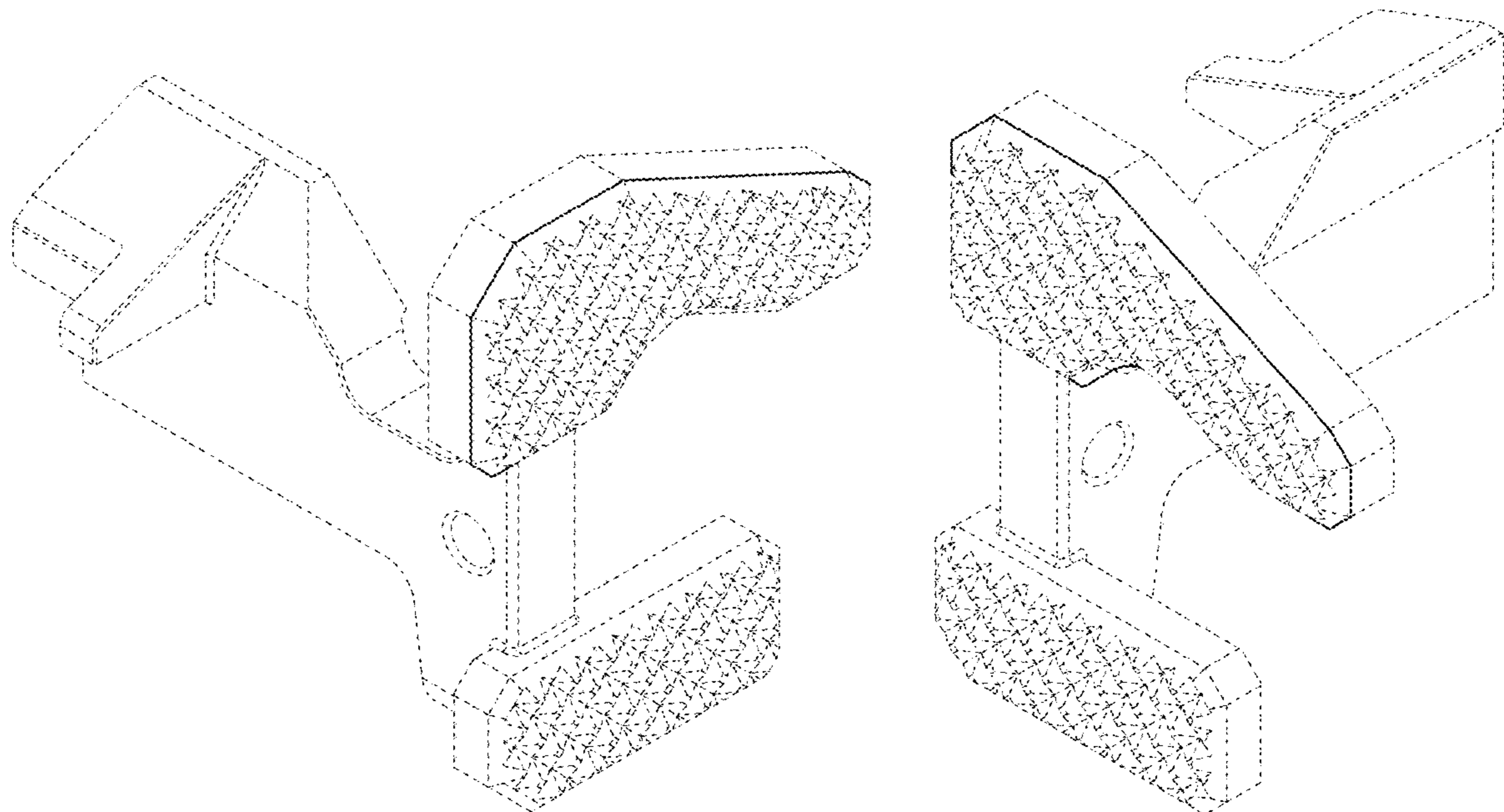

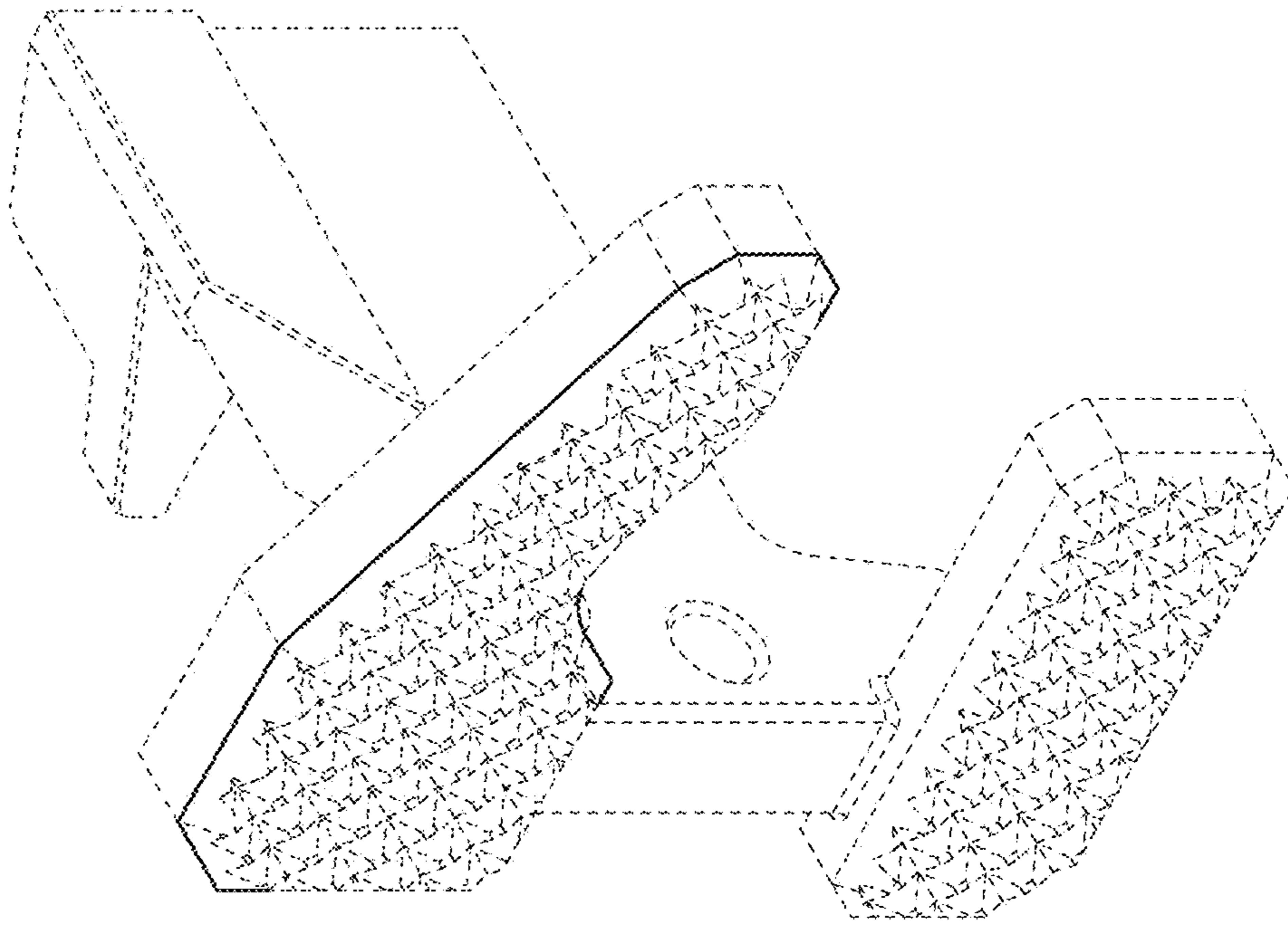

FIG. 2

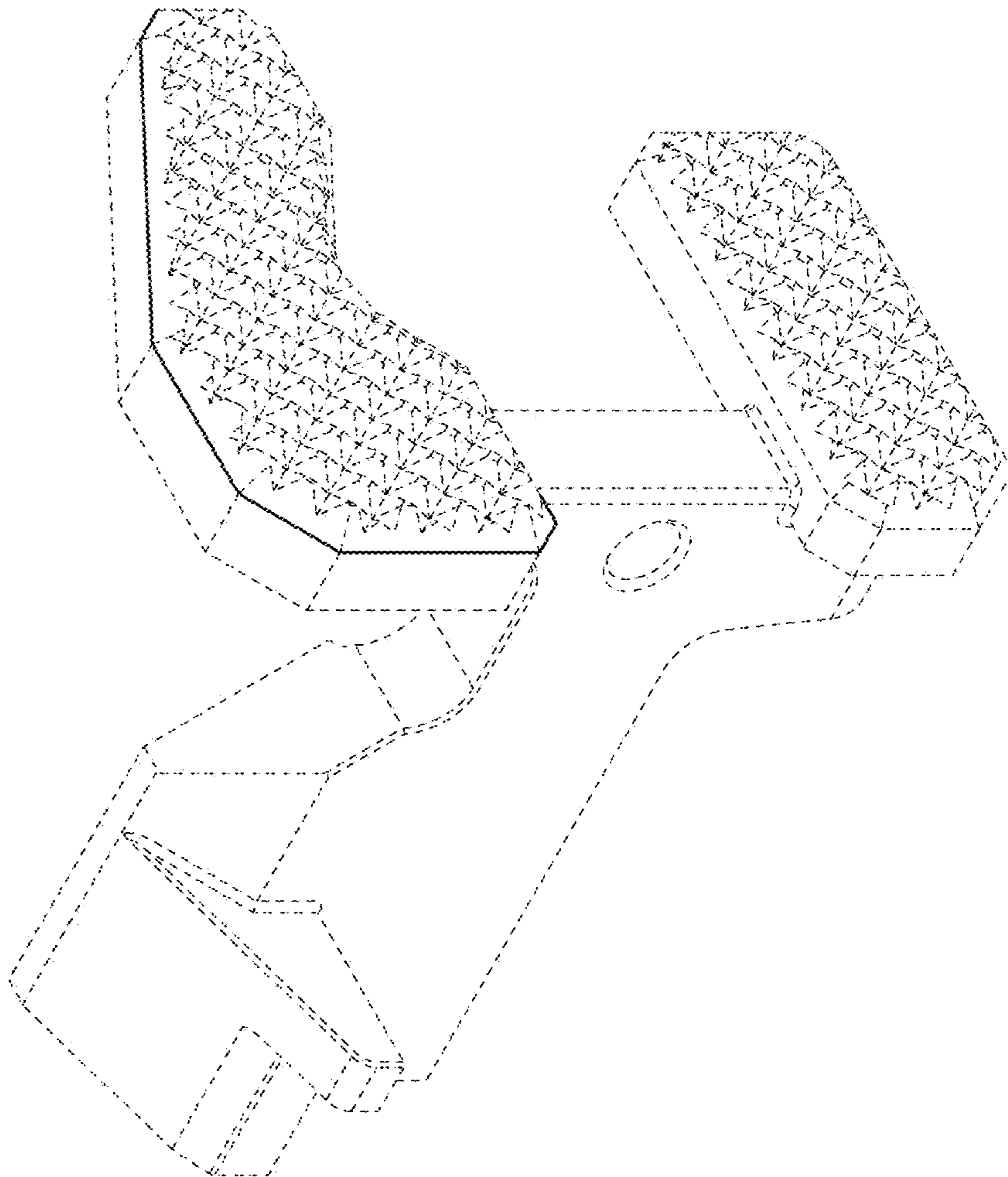

FIG. 1

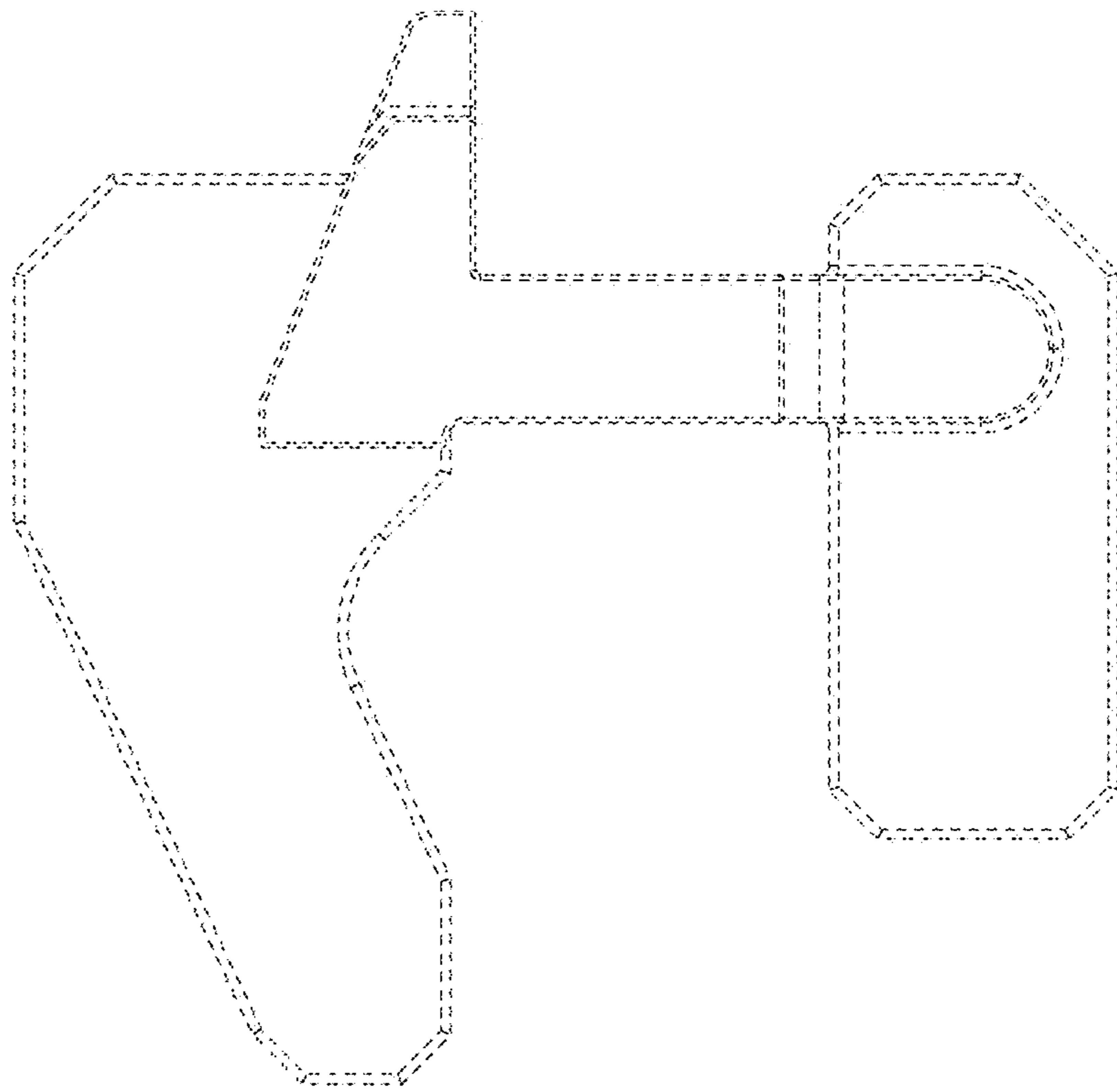

FIG. 4

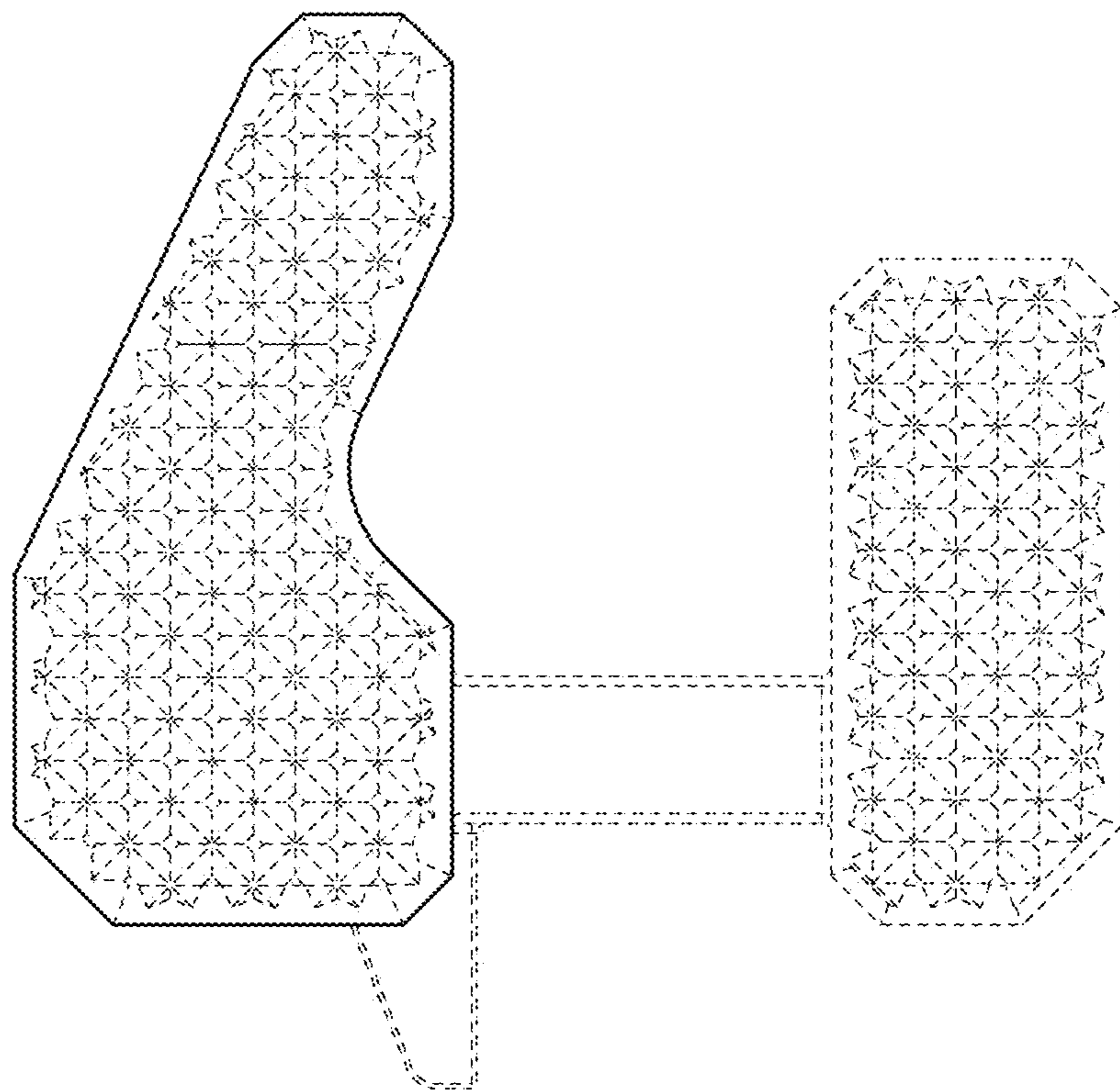

FIG. 3



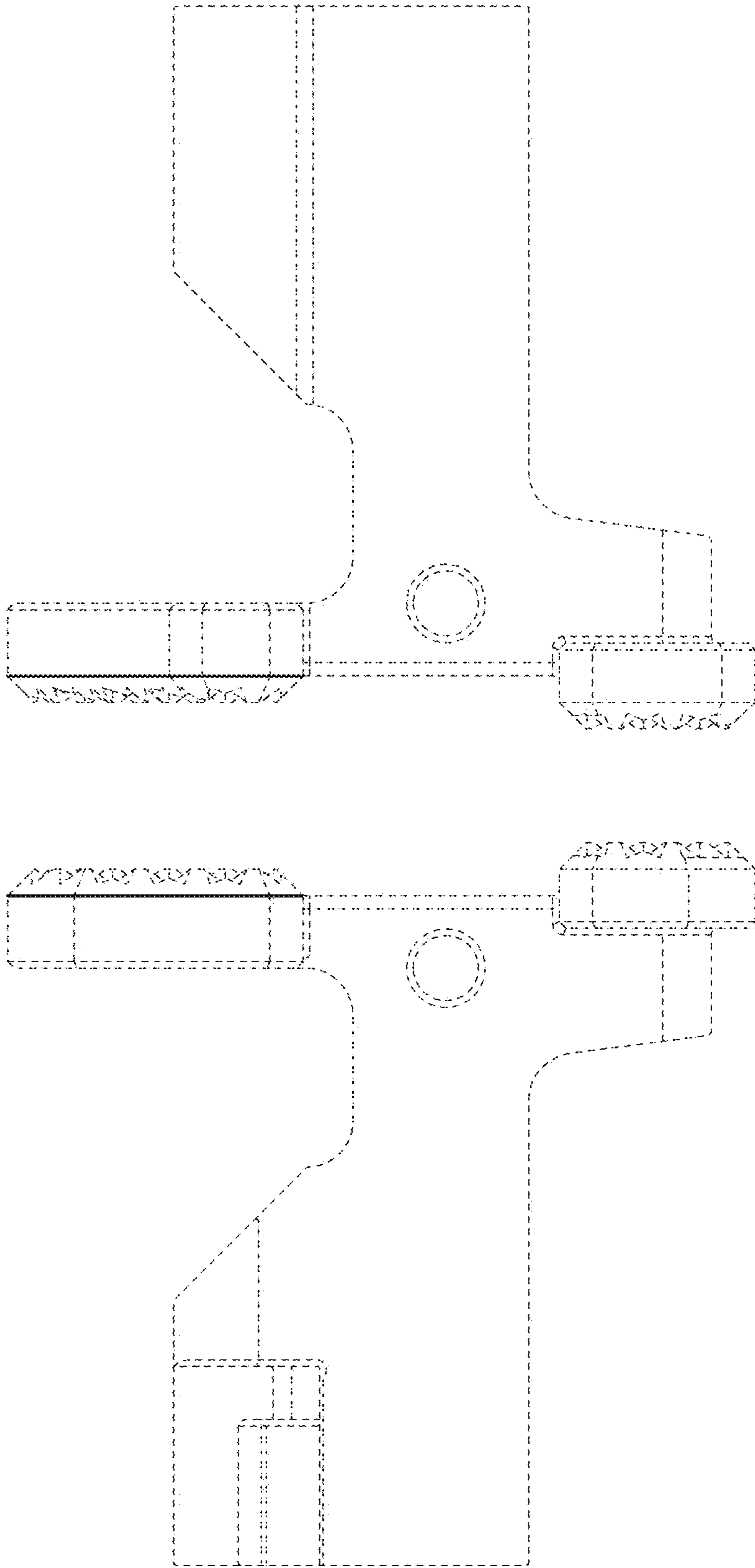

FIG. 6

FIG. 5

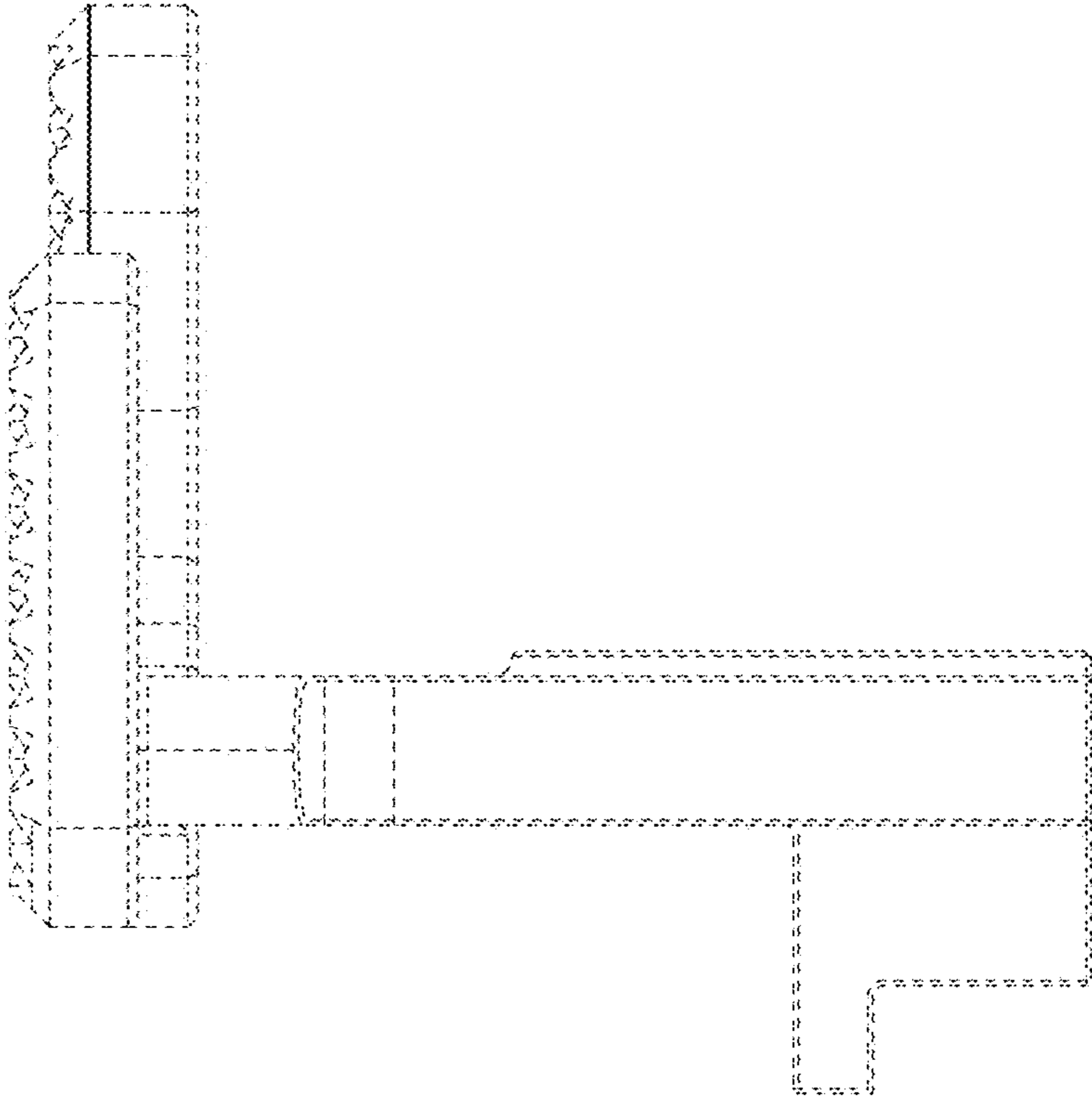

FIG. 7

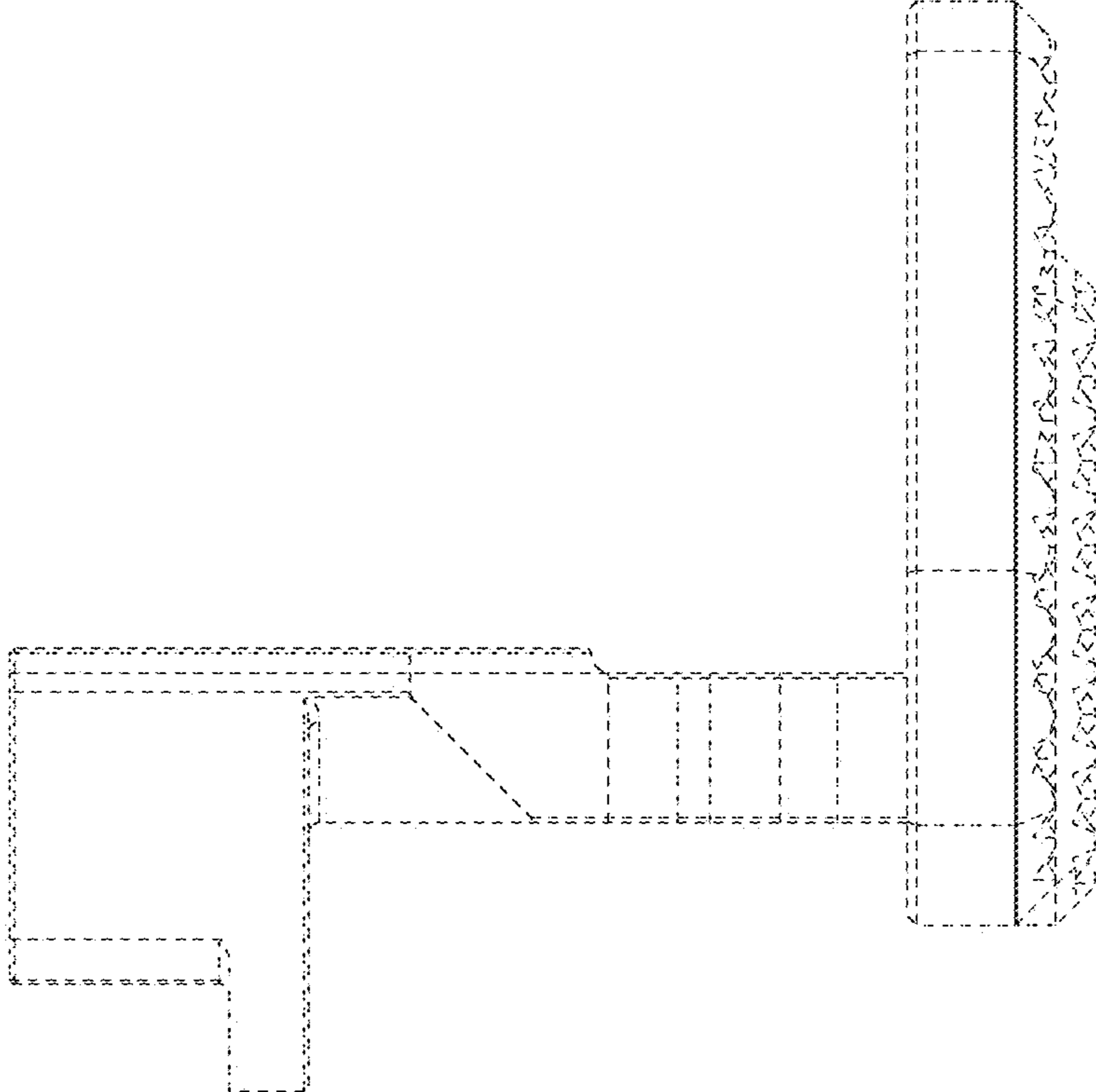

FIG. 8