



US00D805131S

(12) **United States Design Patent** (10) **Patent No.:** **US D805,131 S**
Sparks et al. (45) **Date of Patent:** **** *Dec. 12, 2017**

(54) **ELECTRONIC CONSOLE FOR GAMING AND/OR ENTERTAINMENT PURPOSES**

(71) Applicant: **Microsoft Corporation**, Seattle, WA (US)

(72) Inventors: **Bryan A. Sparks**, Sammamish, WA (US); **Nicolas Denhez**, Seattle, WA (US); **YeongKyu Yoo**, Bellevue, WA (US); **Andrew Kim**, Bellevue, WA (US); **Young Duk Song**, Kirkland, WA (US); **Gregory G. Jones**, Seattle, WA (US); **Carl J. Ledbetter**, Mercer Island, WA (US)

(73) Assignee: **Microsoft Corporation**, Redmond, WA (US)

(*) Notice: This patent is subject to a terminal disclaimer.

(**) Term: **15 Years**

(21) Appl. No.: **29/564,518**

(22) Filed: **May 13, 2016**

(51) **LOC (10) Cl.** **21-01**

(52) **U.S. Cl.**
USPC **D21/332**

(58) **Field of Classification Search**
USPC D14/125, 138 C, 138 R, 140.1, 155, 159, D14/167, 230, 231, 232, 233, 234, 235, D14/236, 237, 238, 240, 242, 243, 299, D14/348, 349, 351, 353, 354, 355, 356, D14/357, 358, 367, 385, 433, 435, 436, D14/474, 480, 496; D13/123, 184; D10/75, 104.1; D21/332, 333
See application file for complete search history.

(56) **References Cited**

U.S. PATENT DOCUMENTS

D336,287 S 6/1993 Mizusugi et al.
D338,882 S 8/1993 Reiter

D341,280 S 11/1993 Garmon
D369,789 S 5/1996 Lucente, II et al.
D393,451 S 4/1998 Faranda et al.
D402,641 S * 12/1998 Heijnen D13/184
5,914,707 A 6/1999 Kono
D412,319 S 7/1999 Lee et al.
D415,740 S 10/1999 Lee et al.

(Continued)

OTHER PUBLICATIONS

X Box One S Console found online [Nov. 2, 2016] http://www.xbox.com/en-US/xbox-one-s?&ocid=PORTALS_SEM_google_microsoft%20xbox&cid=PORTALS_SEM_google_microsoft%20xbox.*

(Continued)

Primary Examiner — Robert M Spear
Assistant Examiner — John Voytek
(74) *Attorney, Agent, or Firm* — Banner & Witcoff, Ltd.

(57) **CLAIM**

The ornamental design for an electronic console for gaming and/or entertainment purposes, as shown and described.

DESCRIPTION

FIG. 1 is a front perspective view of an electronic console for gaming and/or entertainment purposes showing our new design;
FIG. 2 is a front view thereof;
FIG. 3 is a rear view thereof;
FIG. 4 is a left side view thereof;
FIG. 5 is a right side view thereof;
FIG. 6 is a top view thereof; and,
FIG. 7 is a bottom view thereof.
The broken line showing of the various unshaded elements of the electronic console in FIGS. 1-7 is for environmental purposes only and forms no part of the claimed design.

1 Claim, 7 Drawing Sheets

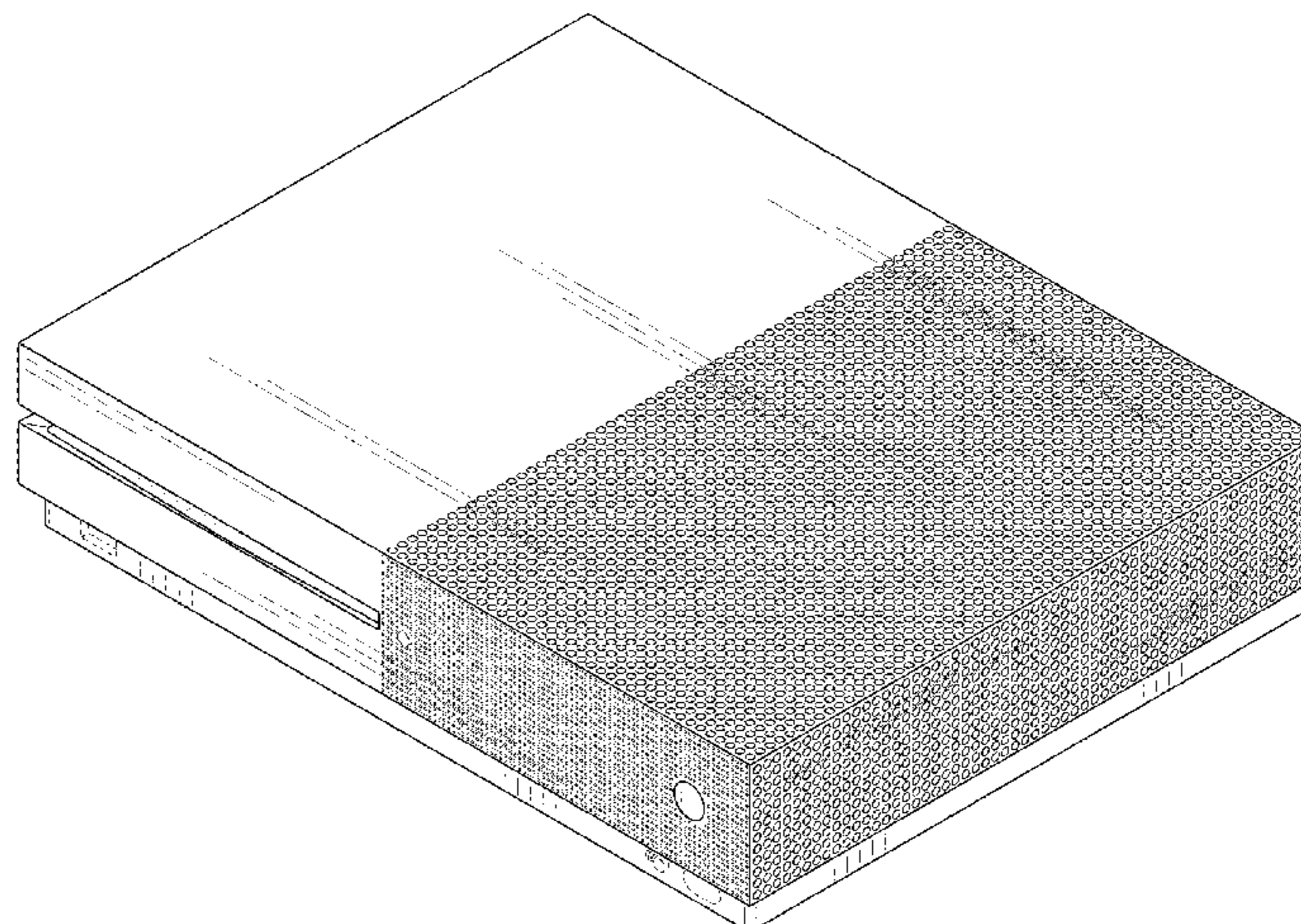

(56)

References Cited

U.S. PATENT DOCUMENTS

D415,741 S 10/1999 Lee et al.
 D416,547 S 11/1999 Lee et al.
 D435,272 S 12/2000 Swanson et al.
 D438,543 S 3/2001 Goto
 D441,759 S 5/2001 Goto
 D452,282 S 12/2001 Stewart et al.
 D452,495 S 12/2001 Murnaghan et al.
 D452,867 S 1/2002 Goto
 D458,269 S 6/2002 Goto
 6,565,444 B2 5/2003 Nagata et al.
 D486,492 S 2/2004 Sheu et al.
 6,930,600 B1 8/2005 Hsieh
 6,941,181 B1 9/2005 Mathurin
 7,090,582 B2 8/2006 Danieli et al.
 D554,582 S 11/2007 Iseki
 D557,680 S 12/2007 Corsini
 D561,186 S 2/2008 Kawase
 D568,276 S 5/2008 Ikeda et al.
 D576,686 S 9/2008 Ashida et al.
 D606,094 S 12/2009 Kimura
 D610,625 S 2/2010 Guinchard et al.
 D641,024 S 7/2011 Zenri et al.
 D647,918 S 11/2011 Ledbetter et al.
 D650,448 S 12/2011 Zenri et al.
 D655,351 S 3/2012 Zenri et al.
 D656,555 S 3/2012 Zenri et al.
 D657,788 S 4/2012 Ledbetter et al.
 D664,993 S 8/2012 Ledbetter et al.
 D665,424 S 8/2012 Ledbetter et al.
 D666,680 S 9/2012 Mercier et al.
 D680,174 S 4/2013 Mercier et al.
 D692,009 S 10/2013 Ashida et al.
 D692,437 S 10/2013 Sugino et al.
 D700,246 S * 2/2014 Jacobs D14/496
 D705,361 S * 5/2014 Jacobs D14/496
 D705,869 S * 5/2014 Jacobs D14/496
 D705,870 S * 5/2014 Jacobs D14/496
 D705,871 S * 5/2014 Jacobs D14/496
 D709,133 S * 7/2014 Jacobs D14/496
 D709,134 S 7/2014 Dallmeyer et al.
 D709,959 S * 7/2014 Jacobs D21/332
 D711,923 S * 8/2014 Dallmeyer D14/495

D713,420 S 9/2014 Dallmeyer et al.
 D719,958 S 12/2014 Dallmeyer et al.
 D726,729 S 4/2015 Lim
 D747,322 S 1/2016 Li
 D766,984 S * 9/2016 Chatterjee D14/496
 D766,985 S * 9/2016 Chatterjee D14/496
 D768,639 S 10/2016 Sumii

OTHER PUBLICATIONS

Nintendo NES [online], [retrieved on May 14, 2013]. Retrieved from internet, http://gamesdbase.com/system-nintendo_nes.aspx.
 Way Back Machine [online], [retrieved Jan. 16, 2013]. Retrieved from internet, <http://web.archive.org/web/20130116120917/http://www.klipsch.com/gallery-g17-air>.
 “Nintendo Wii Review”, Top 10 Reviews ; URL: <<http://www.toptenreviews.com/electronics/gaming/best-video-game-consoles/nintendo-wii/review/>>; date accessed Sep. 27, 2016.
 “PS4 Console”, PS4 Features, Games & Videos ; <URL:<https://www.playstation.com/en-us/explore/ps4/>>; date accessed Sep. 27, 2016.
 “Sony Playstation 2”, The Video Game Critic’s Console Reviews ; <URL:<http://videogamecritic.com/ps2info.htm>> ; date accessed Sep. 27, 2016.
 Nintendo NES [online], [retrieved on May 14, 2013]. Retrieved from internet, <http://gamesdbase.com/system-nintendo_nes.aspx>.
 Nov. 30, 2016—(U.S.) Non-Final Office Action—U.S. Appl. No. 29/564,527, filed May 13, 2016; Inv.: Bryan A. Sparks.
 Nov. 28, 2016—(U.S.) Non-Final Office Action—U.S. Appl. No. 29/564,514, filed May 13, 2016; Inv.: Bryan A. Sparks.
 Nov. 30, 2016—(U.S.) Non-Final Office Action—U.S. Appl. No. 29/564,511, filed May 13, 2016; Inv.: Bryan A. Sparks.
 Nov. 30, 2016—(U.S.) Non-Final Office Action—U.S. Appl. No. 29/564,522, filed May 13, 2016; Inv.: Bryan A. Sparks.
 U.S. Appl. No. 29/564,511, filed May 13, 2016.
 U.S. Appl. No. 29/564,514, filed May 13, 2016.
 U.S. Appl. No. 29/564,522, filed May 13, 2016.
 U.S. Appl. No. 29/566,652, filed Jun. 1, 2016.
 U.S. Appl. No. 29/564,601, filed May 13, 2016.
 U.S. Appl. No. 29/565,527, filed May 13, 2016.

* cited by examiner

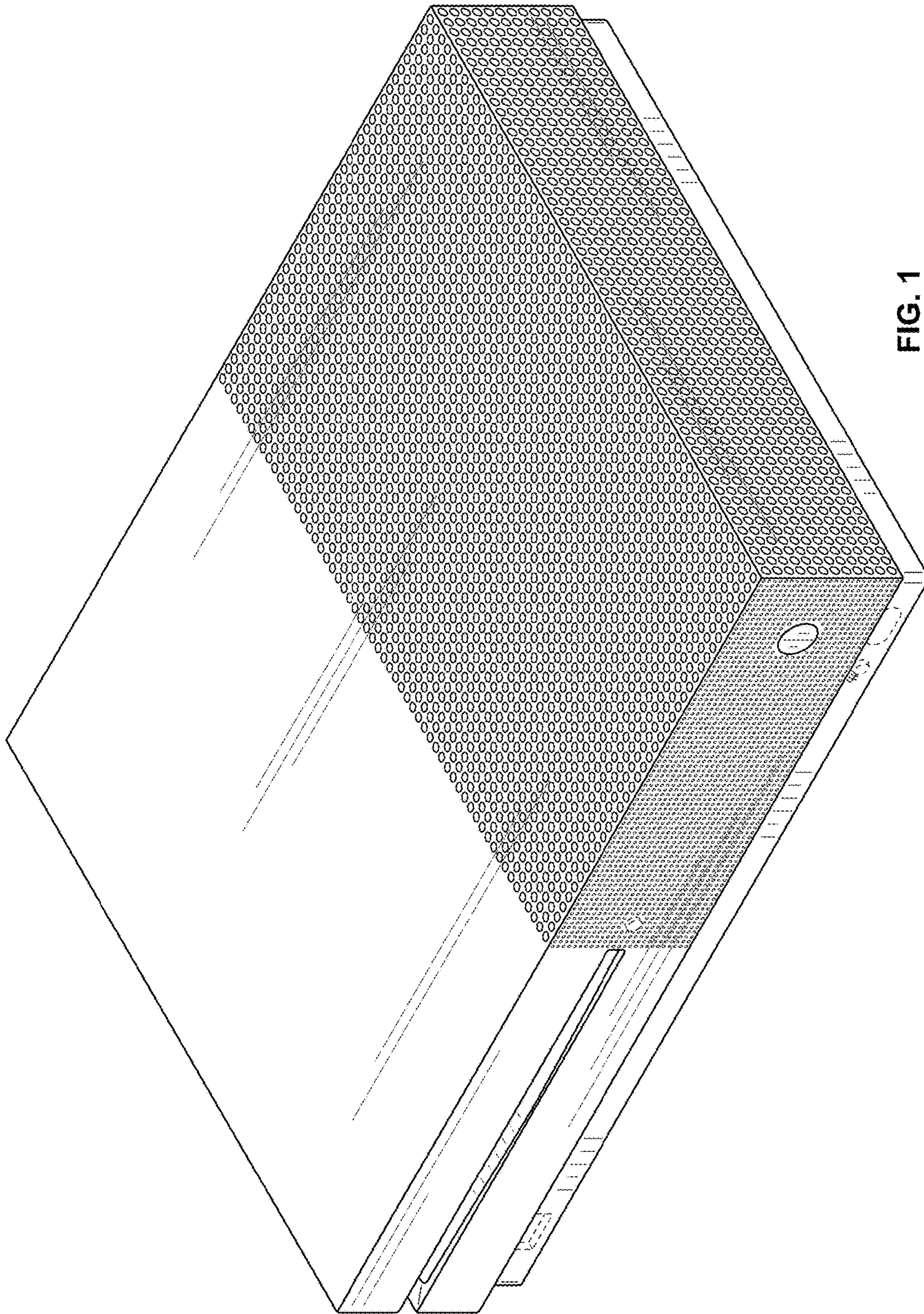

FIG. 1

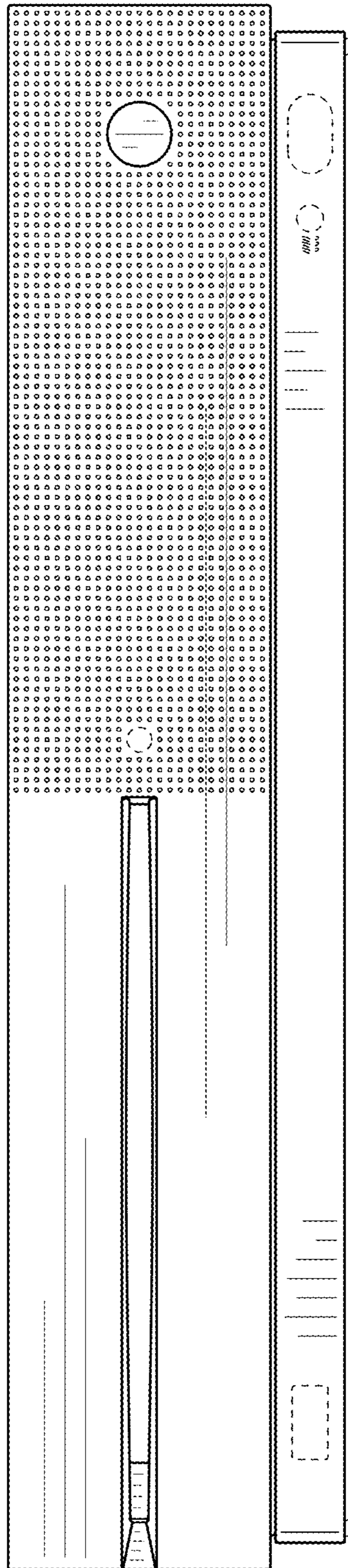

FIG. 2

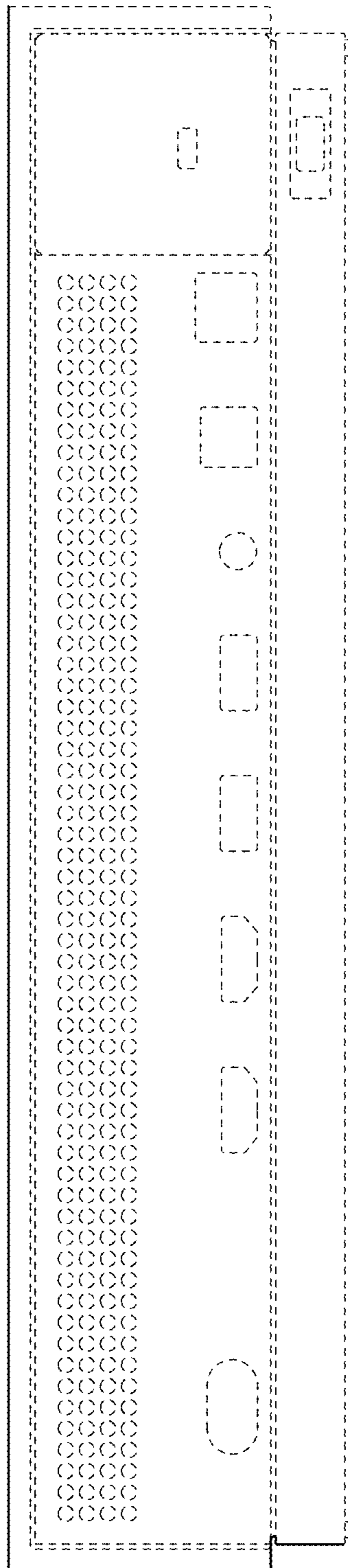

FIG. 3

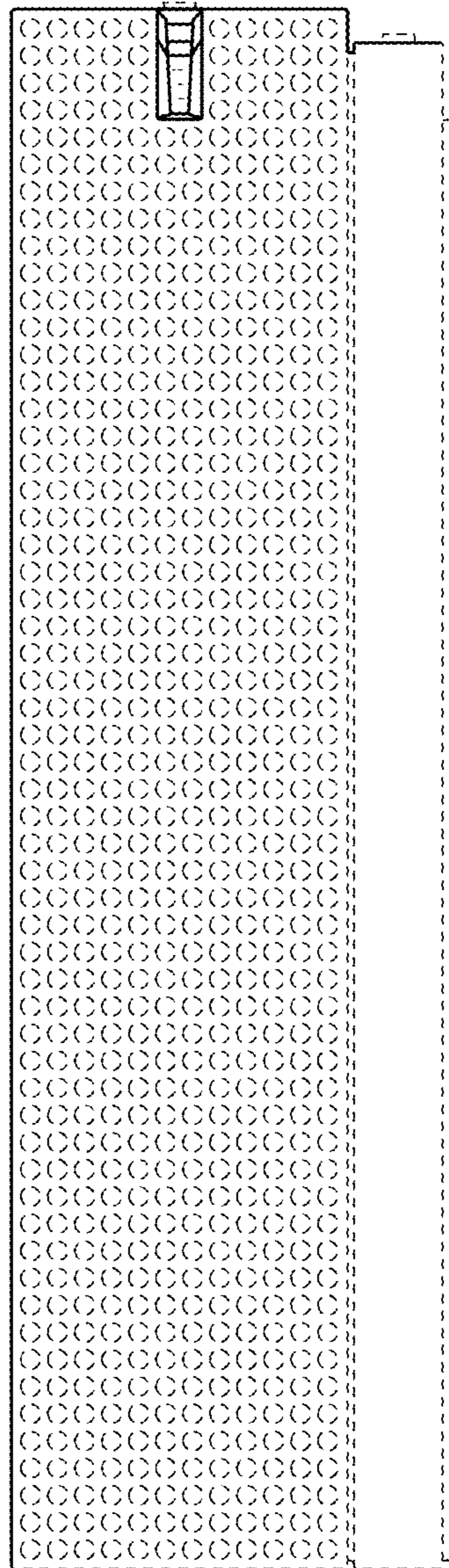

FIG. 4

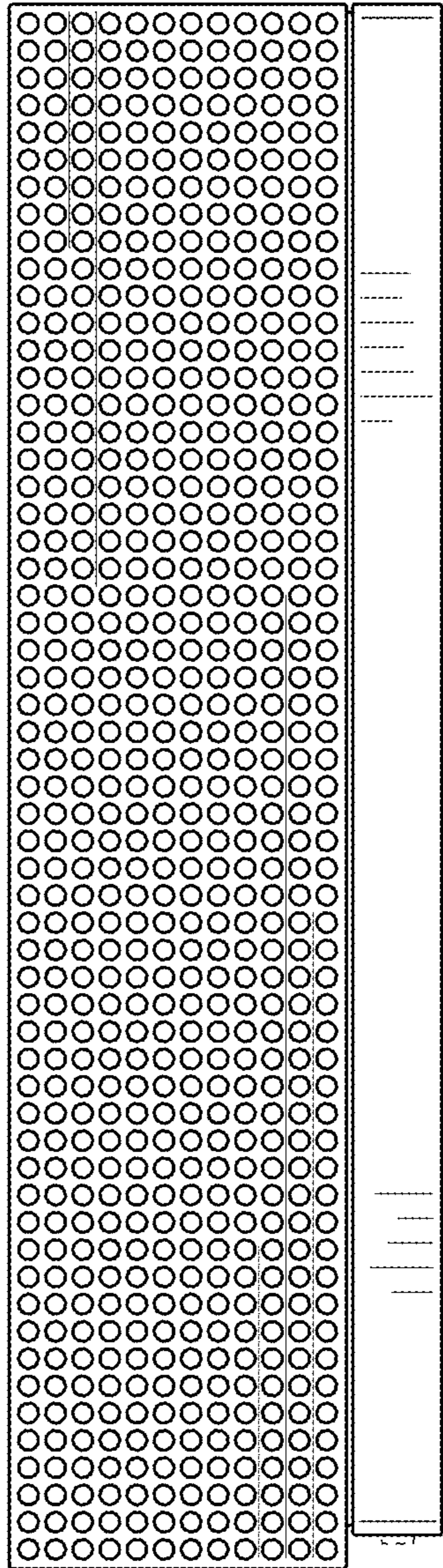

FIG. 5

FIG. 6

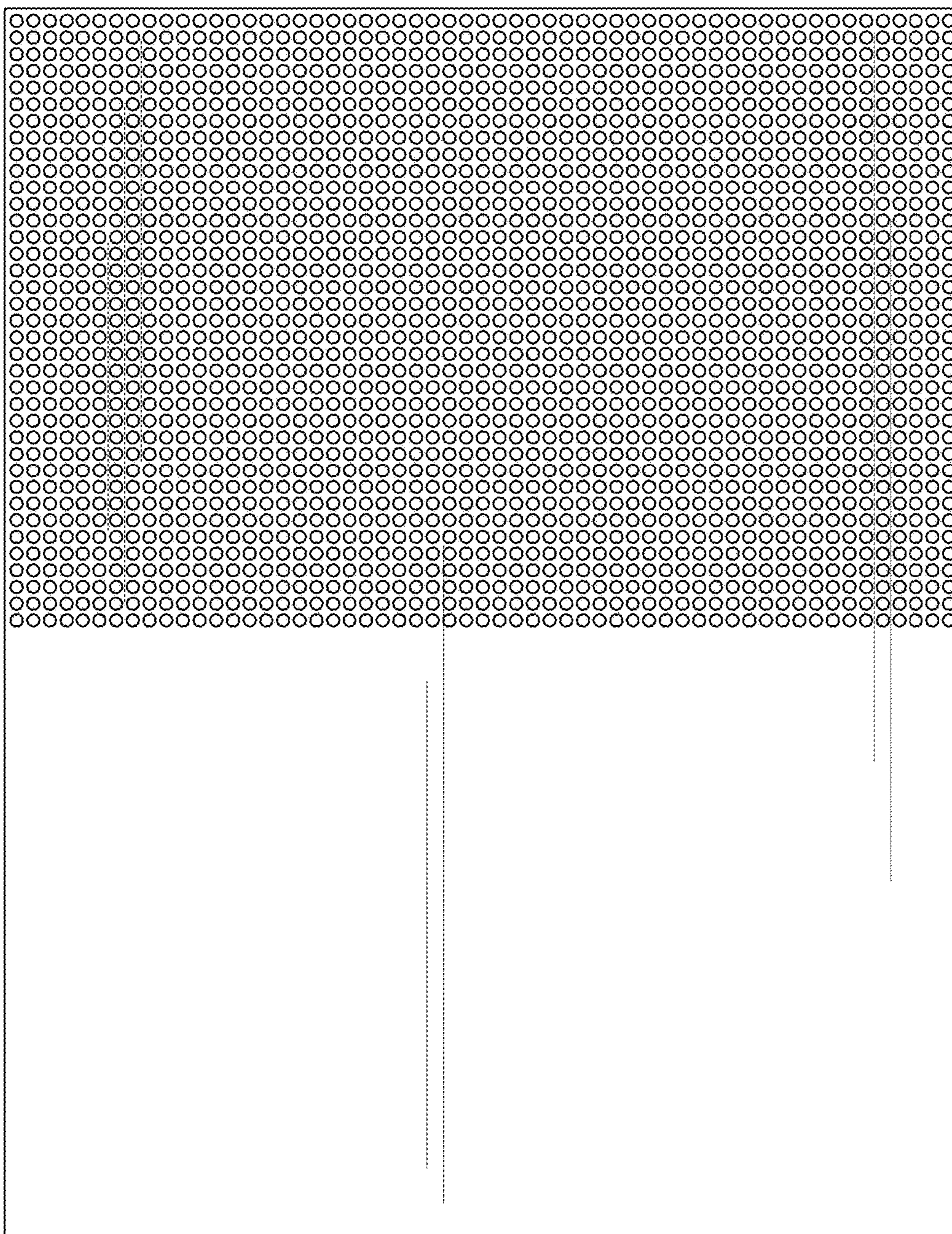



FIG. 7