



US00D804993S

(12) **United States Design Patent** (10) **Patent No.:** **US D804,993 S**
Eck et al. (45) **Date of Patent:** **** Dec. 12, 2017**

(54) **OFF-ROAD VEHICLE**
(71) Applicant: **BOMBARDIER RECREATIONAL PRODUCTS INC., Valcourt (CA)**
(72) Inventors: **Richard Eck, Bromont (CA); Matt Tandrup, Bromont (CA); Alexei Mikhailov, Bromont (CA)**
(73) Assignee: **BOMBARDIER RECREATIONAL PRODUCTS INC., Valcourt (CA)**
(**) Term: **15 Years**
(21) Appl. No.: **29/574,147**
(22) Filed: **Aug. 12, 2016**
(51) **LOC (10) Cl.** **12-08**
(52) **U.S. Cl.**
USPC **D12/87**
(58) **Field of Classification Search**
USPC D12/3, 4, 5, 14, 85, 86, 87, 107, 110
CPC B62D 23/00; B62D 21/18; B62D 21/183;
B62D 24/02; B62D 25/00; B62D 39/00;
B62D 49/06; B62D 49/0621
See application file for complete search history.

D631,792 S 2/2011 Sanschagrin
D631,793 S 2/2011 Sanschagrin
D631,794 S 2/2011 Sanschagrin
D633,006 S 2/2011 Sanschagrin et al.
D640,171 S * 6/2011 Danisi D12/87
D650,311 S * 12/2011 Bracy D12/87
D655,236 S 3/2012 Sanschagrin
D656,457 S 3/2012 Crepeau
D660,746 S * 5/2012 Bracy D12/87
8,613,335 B2 * 12/2013 Deckard B60K 17/08
180/68.1
D701,469 S * 3/2014 Lai D12/87
D703,102 S * 4/2014 Eck D12/87
D709,798 S 7/2014 Matsumura
D712,311 S * 9/2014 Morgan D12/87
8,827,019 B2 * 9/2014 Deckard B60K 17/08
180/68.1
D717,695 S 11/2014 Matsumura
D719,061 S * 12/2014 Tandrup D12/87
(Continued)

Primary Examiner — Darlington Ly
(74) *Attorney, Agent, or Firm* — BCF LLP

(57) **CLAIM**
The ornamental design for an off-road vehicle, as shown and described.

DESCRIPTION

FIG. 1 is a right side elevation view of an off-road vehicle showing our new design;
FIG. 2 is a left side elevation view thereof;
FIG. 3 is a front elevation view thereof;
FIG. 4 is a rear elevation view thereof;
FIG. 5 is a top plan elevation view thereof;
FIG. 6 is a bottom plan elevation view thereof;
FIG. 7 is a front and right side perspective view thereof; and,
FIG. 8 is a rear and left side perspective view thereof.
The broken lines in the drawings illustrate portions of the off-road vehicle that form no part of the claimed design.

1 Claim, 8 Drawing Sheets

(56) **References Cited**
U.S. PATENT DOCUMENTS
D301,849 S * 6/1989 Oba D12/87
D327,237 S * 6/1992 Miyamoto D12/87
D439,548 S 3/2001 Kouchi et al.
D498,435 S 11/2004 Saito et al.
D503,905 S 4/2005 Saito et al.
D513,223 S 12/2005 Saito et al.
D549,133 S * 8/2007 LePage D12/87
D601,058 S * 9/2009 Evenson D12/107
D622,631 S * 8/2010 Lai D12/87
D622,645 S 8/2010 Ichihara et al.
D631,395 S 1/2011 Tandrup et al.
D631,791 S 2/2011 Sanschagrin

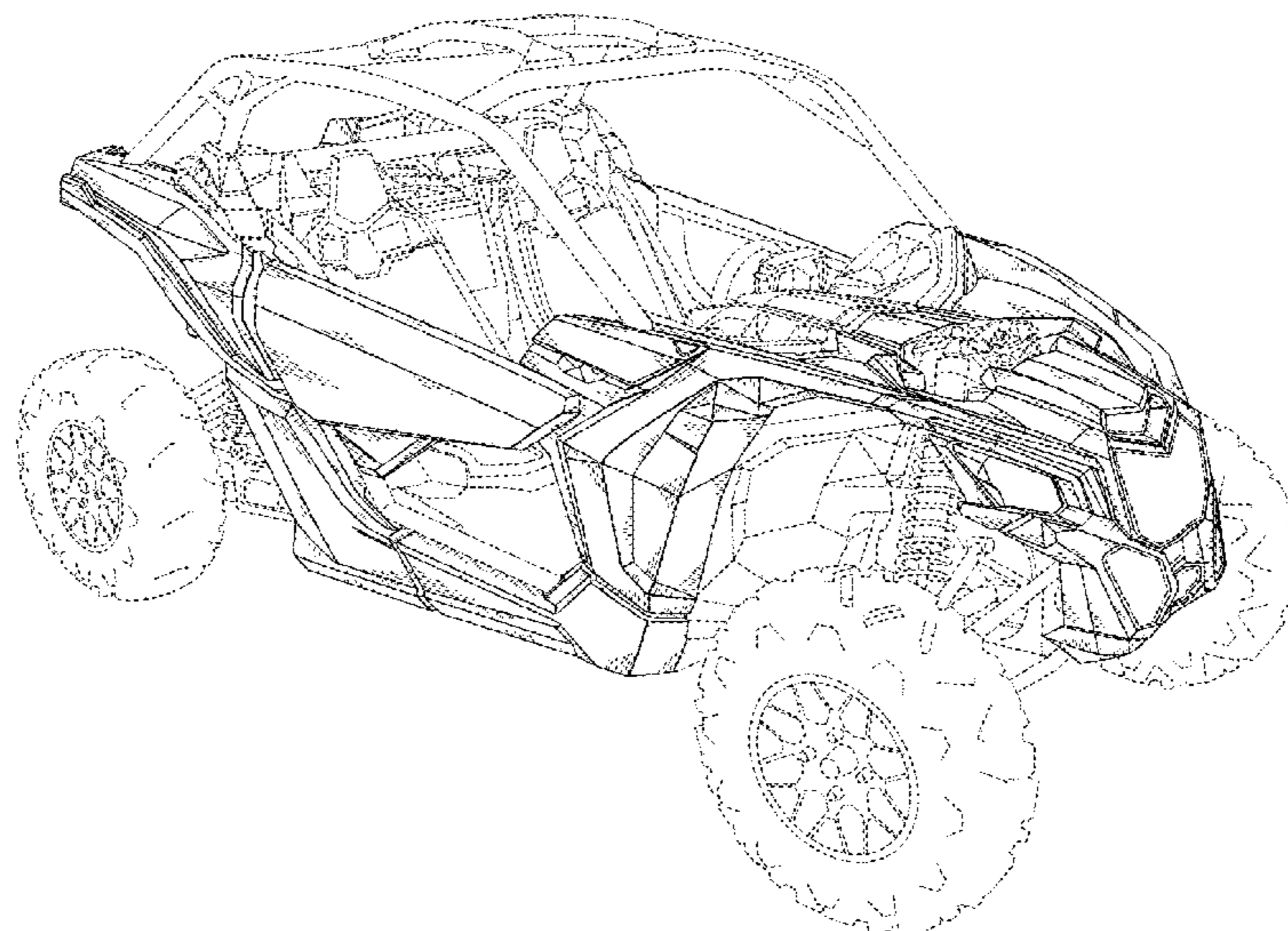

(56)

References Cited

U.S. PATENT DOCUMENTS

D727,243 S 4/2015 Matsumura
D727,244 S 4/2015 Hashimoto
D727,794 S 4/2015 Tandrup et al.
D730,239 S 5/2015 Gonzalez
D734,689 S 7/2015 Hashimoto
D736,118 S 8/2015 Hashimoto et al.
9,211,924 B2* 12/2015 Safranski B60G 3/14
9,327,587 B2* 5/2016 Spindler B62D 23/005
D762,517 S 8/2016 Hashimoto et al.
D762,522 S* 8/2016 Kinoshita D12/87
D764,972 S 8/2016 Gonzalez
D764,973 S 8/2016 Mikhailov et al.
D764,974 S 8/2016 Mikhailov et al.
D772,755 S* 11/2016 Tandrup D12/14
2012/0031688 A1* 2/2012 Safranski B60G 3/14
180/54.1
2012/0152637 A1* 6/2012 Hapka B60K 23/04
180/233

* cited by examiner

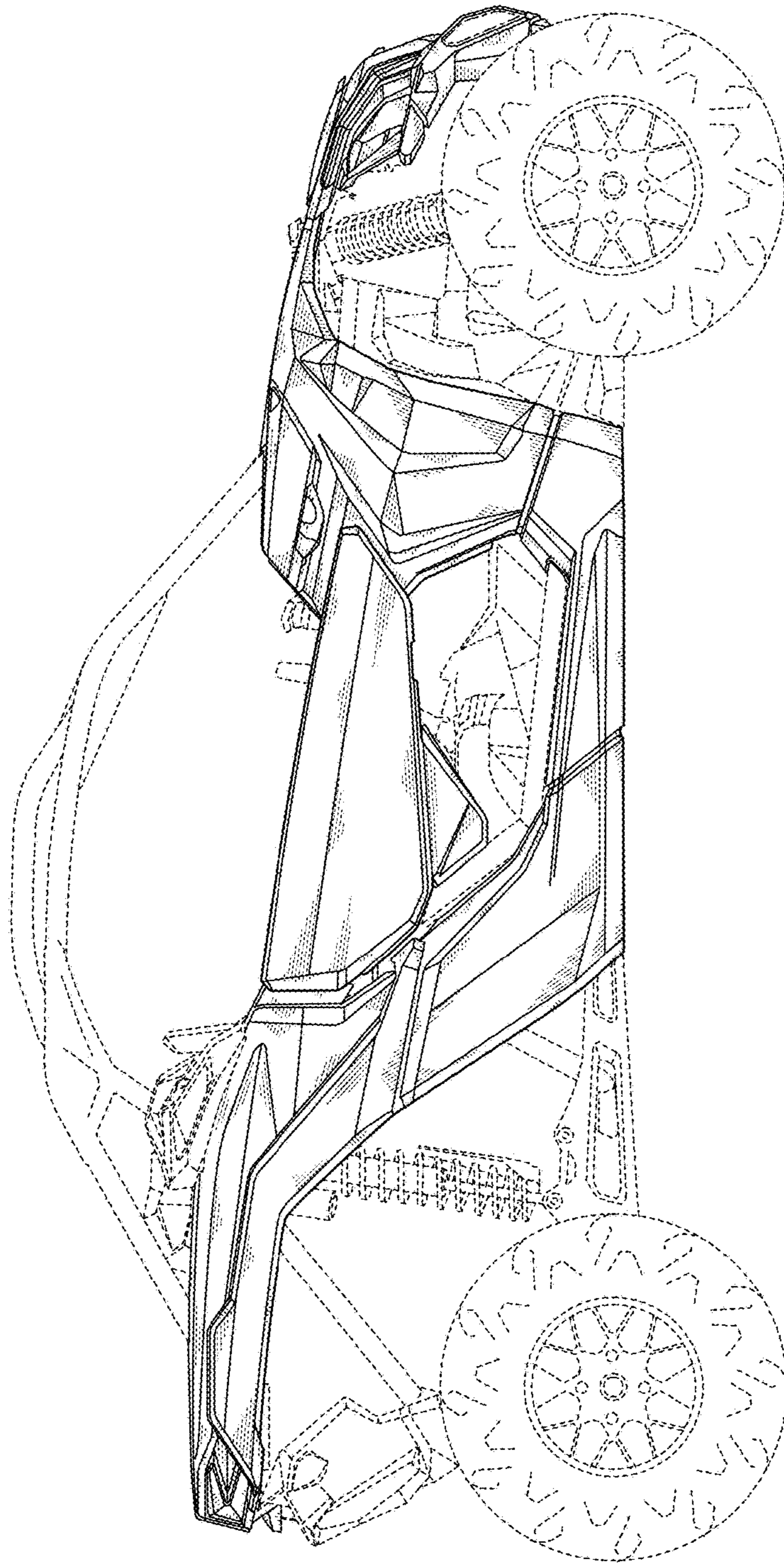

Fig.1

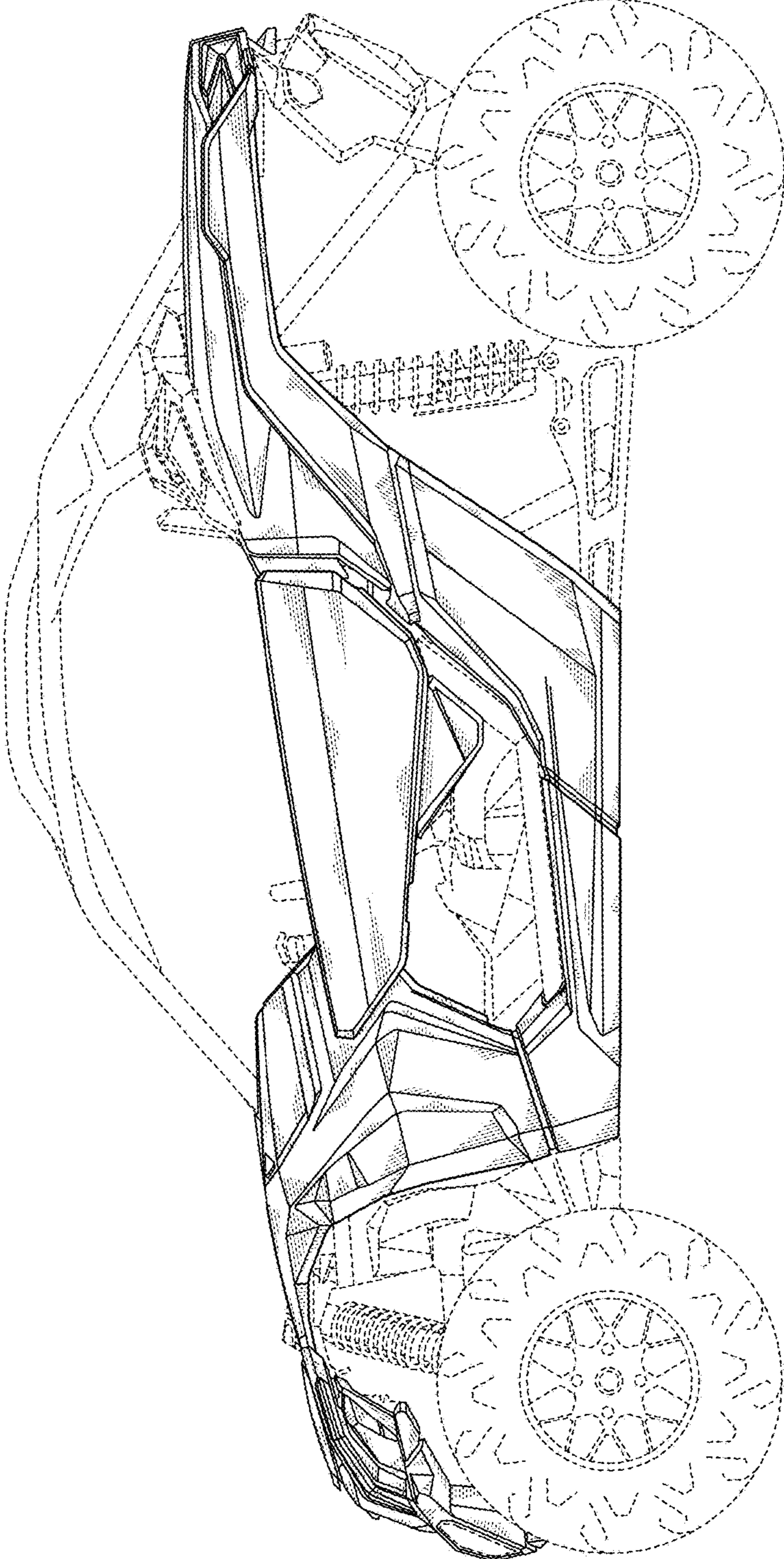

Fig.2

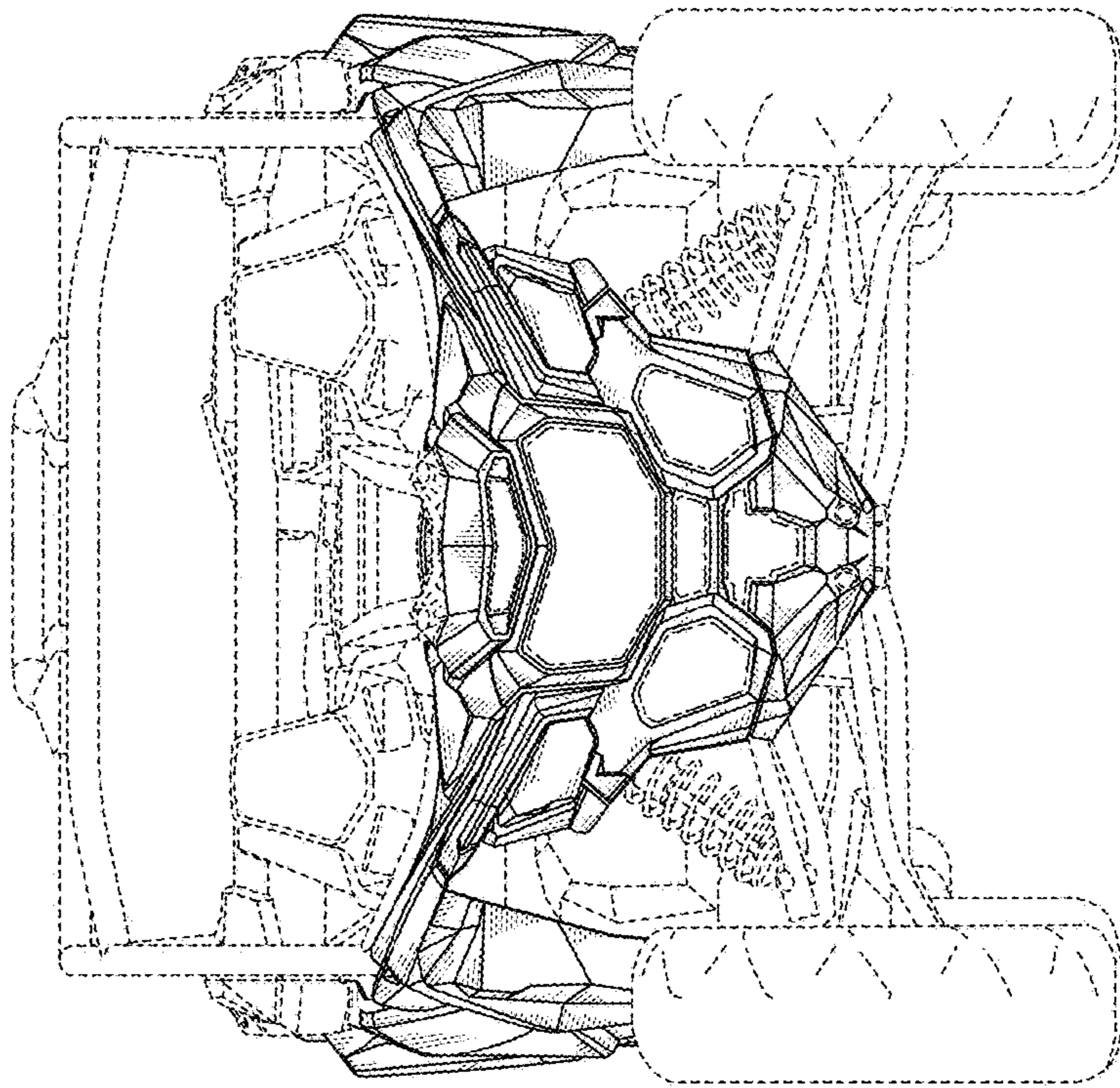

Fig.3

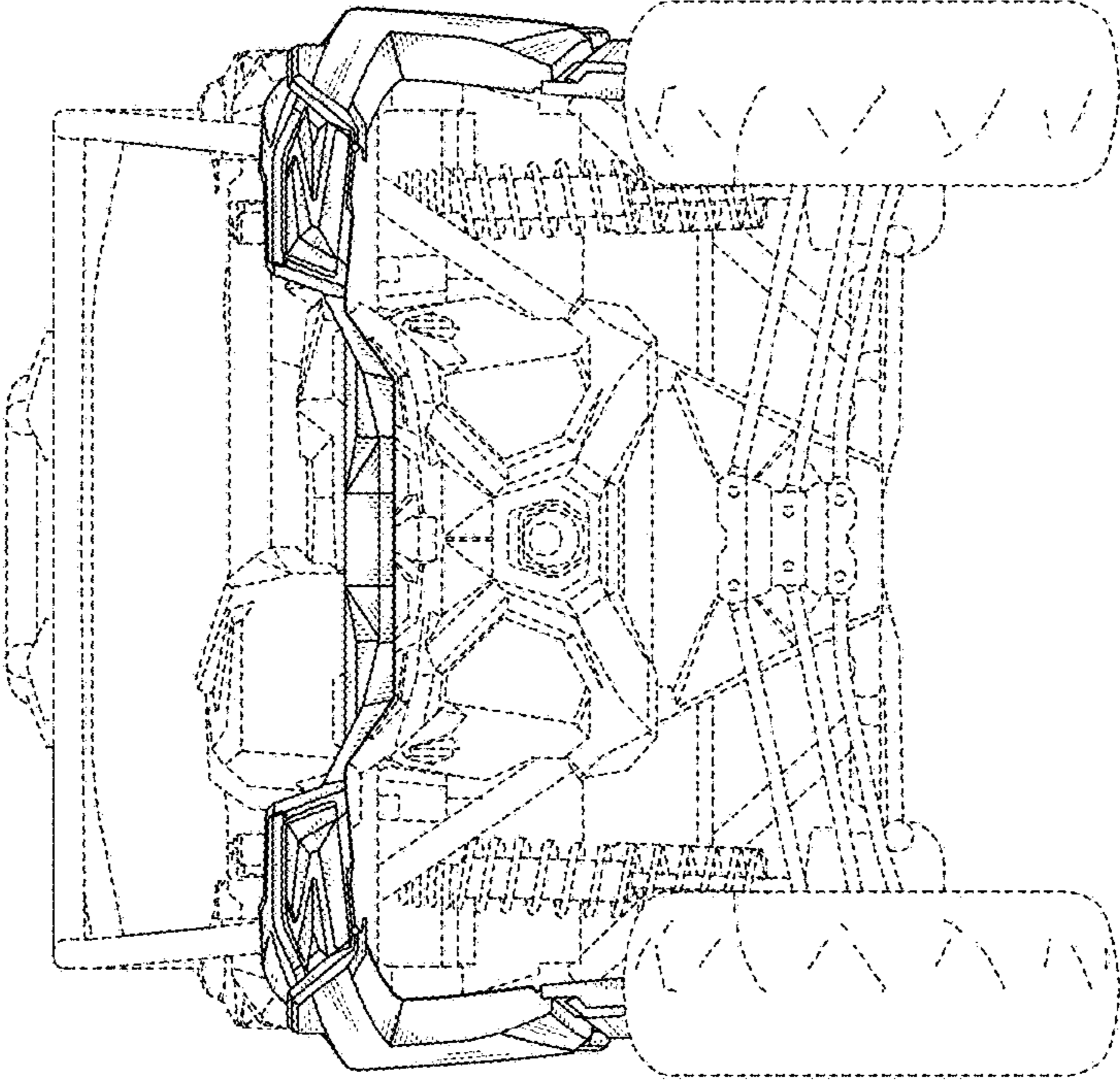

Fig.4

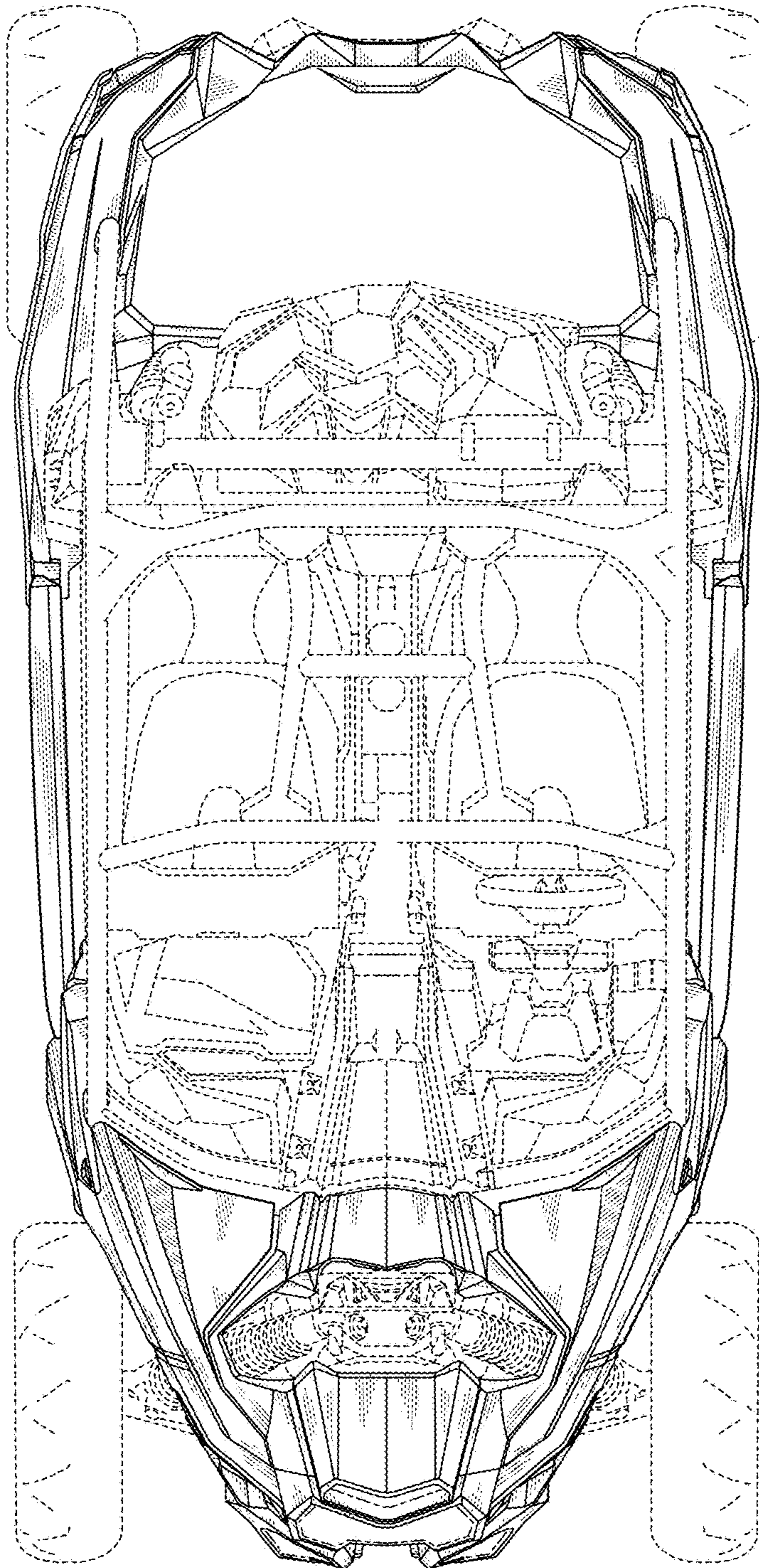

Fig.5

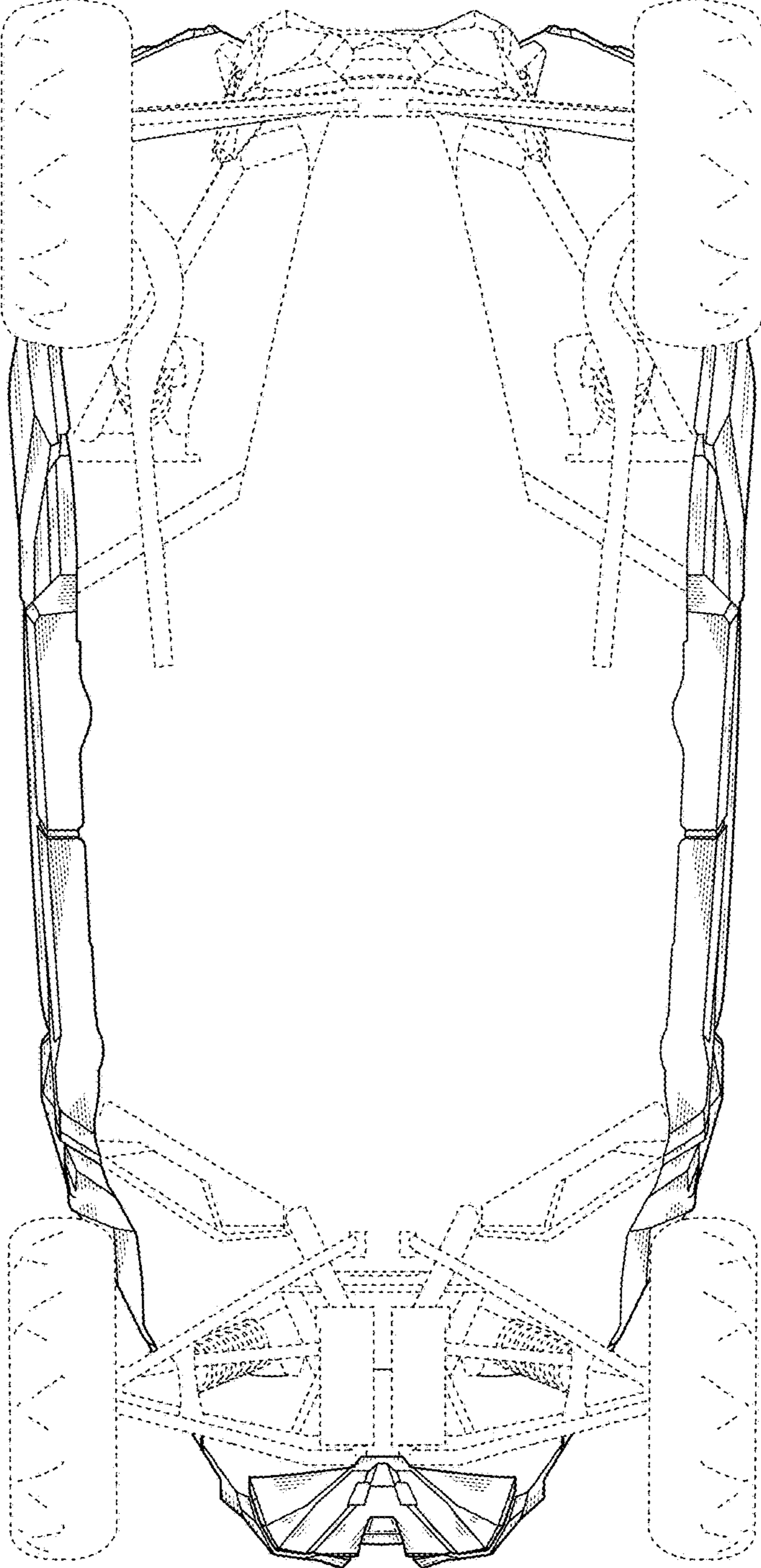

Fig.6

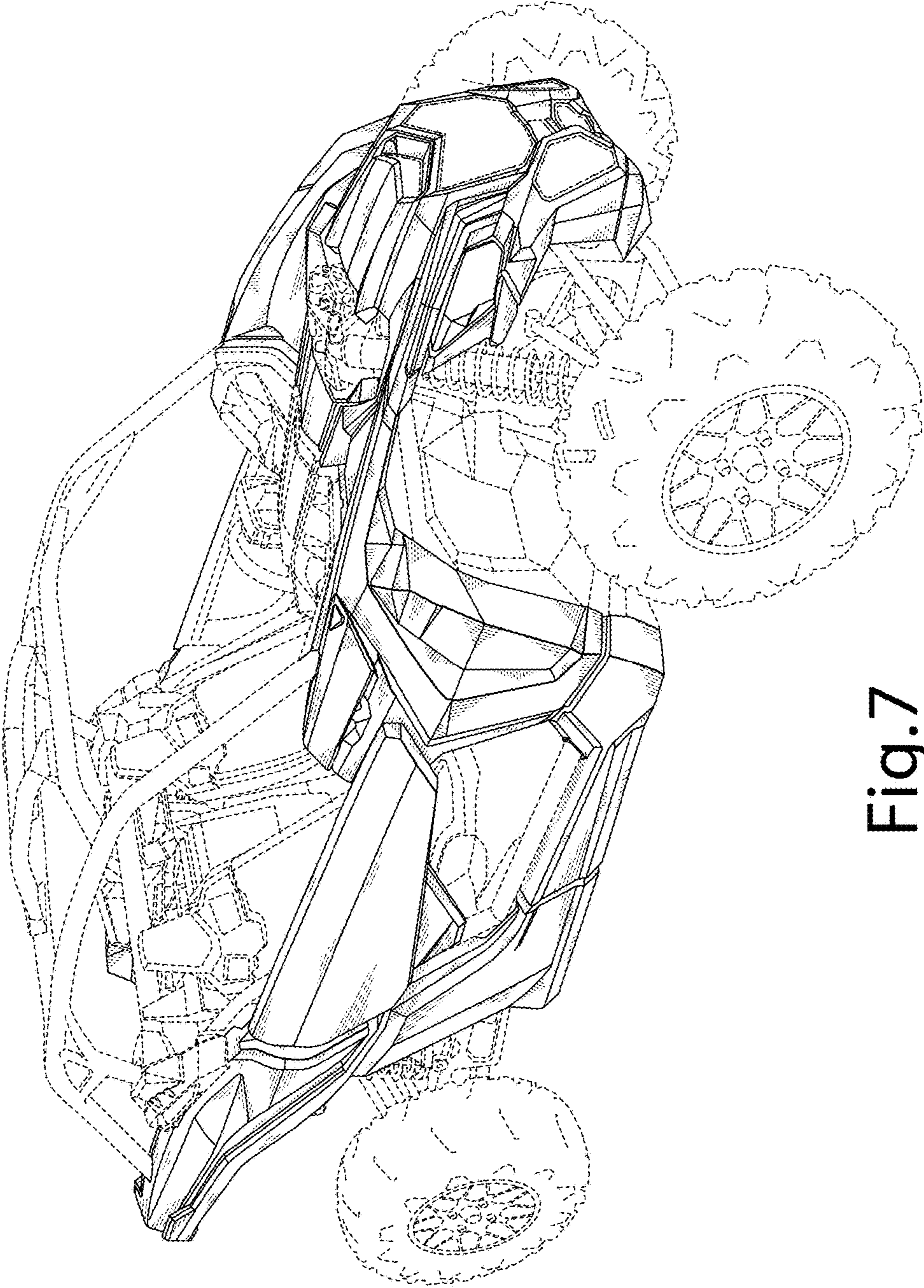

Fig.7

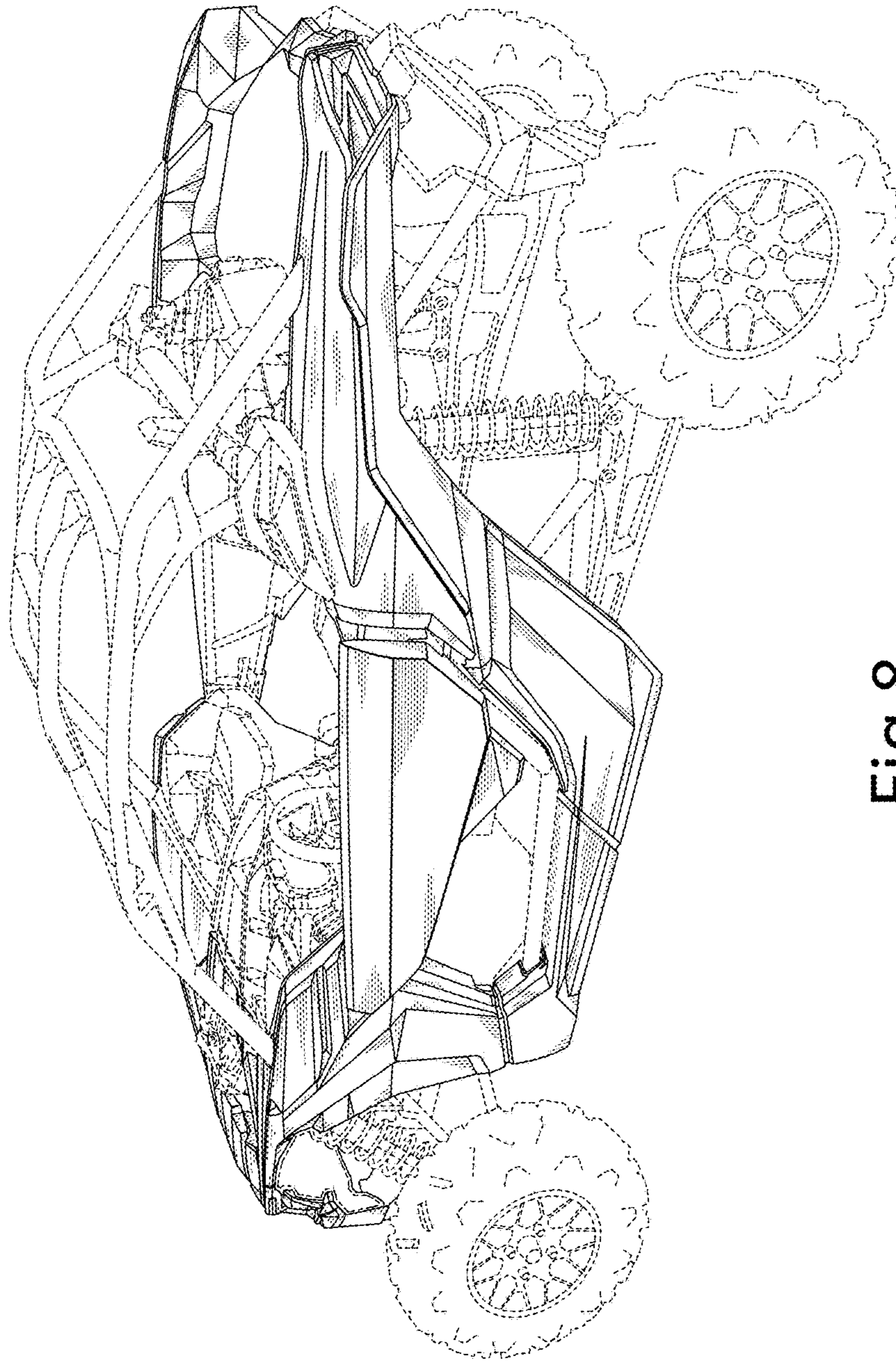

Fig.8

UNITED STATES PATENT AND TRADEMARK OFFICE
CERTIFICATE OF CORRECTION

PATENT NO. : D804,993 S
APPLICATION NO. : 29/574147
DATED : December 12, 2017
INVENTOR(S) : Richard Eck et al.

Page 1 of 1

It is certified that error appears in the above-identified patent and that said Letters Patent is hereby corrected as shown below:

On the Title Page

Insert under Item (56) FOREIGN PATENT DOCUMENTS:

--EM 001791096-0002 (2010-12)--

Signed and Sealed this
Sixth Day of February, 2018

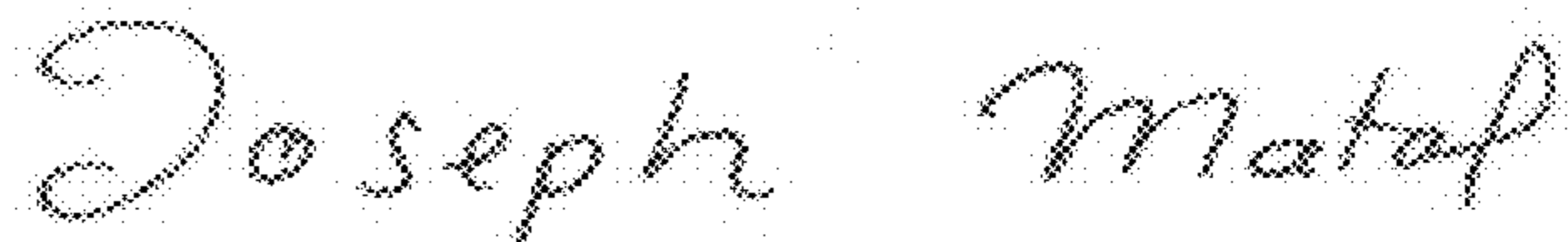

Joseph Matal

*Performing the Functions and Duties of the
Under Secretary of Commerce for Intellectual Property and
Director of the United States Patent and Trademark Office*