



US00D804910S

(12) **United States Design Patent**  
**Steel et al.**

(10) **Patent No.:** **US D804,910 S**

(45) **Date of Patent:** **\*\* Dec. 12, 2017**

(54) **MUG**

(71) Applicants: **Jeffrey Steel**, Hoboken, NJ (US);  
**Christon G. Suess**, Paramus, NJ (US)

(72) Inventors: **Jeffrey Steel**, Hoboken, NJ (US);  
**Christon G. Suess**, Paramus, NJ (US)

(73) Assignee: **Cotapaxi, Custom Design and Manufacturing LLC**, Carlstadt, NJ (US)

(\*\*) Term: **15 Years**

(21) Appl. No.: **29/577,470**

(22) Filed: **Sep. 13, 2016**

**Related U.S. Application Data**

(63) Continuation-in-part of application No. 29/546,844, filed on Nov. 25, 2015.

(51) **LOC (10) Cl.** ..... **07-01**

(52) **U.S. Cl.**  
USPC ..... **D7/531**; D10/46.2; D7/532

(58) **Field of Classification Search**  
USPC ..... D7/507, 509, 510, 511, 523, 529, 530, D7/531, 532, 533, 536, 392.1, 396.2, 394, D7/396.4, 300, 1, 642, 688, 697, 690; 220/592.16, 592.17, 710.5, 495.03; D9/565, 552, 455, 454; D10/46.2  
CPC ..... B65D 47/066; A47J 43/27; A47G 19/22; A47G 19/2222; A47G 19/2227; A45F 3/20

See application file for complete search history.

(56) **References Cited**

**U.S. PATENT DOCUMENTS**

D280,281 S \* 8/1985 Conti ..... D7/602  
D282,897 S \* 3/1986 Conti ..... D22/126

D510,235 S \* 10/2005 Sorensen ..... D7/510  
D584,569 S \* 1/2009 Buchman ..... D7/602  
D644,065 S \* 8/2011 Llerena ..... D7/300.1  
D666,047 S \* 8/2012 Lin ..... D7/300.1  
D697,798 S \* 1/2014 Sorensen ..... D9/429  
D726,476 S \* 4/2015 Ercanbrack ..... D7/300.1  
D727,097 S \* 4/2015 Sorensen ..... D7/505  
D732,339 S \* 6/2015 Sorensen ..... D7/509  
D733,497 S \* 7/2015 Sorensen ..... D7/509  
D751,344 S \* 3/2016 Charlton ..... D7/300.1  
D754,479 S \* 4/2016 Tae ..... D7/509  
D766,029 S \* 9/2016 Lin ..... D7/300.1  
D771,990 S \* 11/2016 Horowitz ..... D7/300.1  
2012/0152781 A1 \* 6/2012 Tussy ..... B65D 1/165  
206/459.1  
2013/0062304 A1 \* 3/2013 Meyers ..... B65D 43/00  
215/240  
2014/0360908 A1 \* 12/2014 Sorensen ..... B65D 21/0228  
206/501

\* cited by examiner

*Primary Examiner* — Marianne N Pandozzi

*Assistant Examiner* — Jae Liang

(74) *Attorney, Agent, or Firm* — Steven E. Shapiro

(57) **CLAIM**

The ornamental design for a mug, as shown and described.

**DESCRIPTION**

FIG. 1 is a top perspective view of a mug;  
FIG. 2 is a front view of the mug;  
FIG. 3 is a rear view of the mug;  
FIG. 4 is a right side view of the mug;  
FIG. 5 is a left side view of the mug;  
FIG. 6 is a top view of the mug; and,  
FIG. 7 is a bottom view of the mug.  
The broken lines shown in the drawings represent portions of the mug that form no part of the claimed design.

**1 Claim, 7 Drawing Sheets**

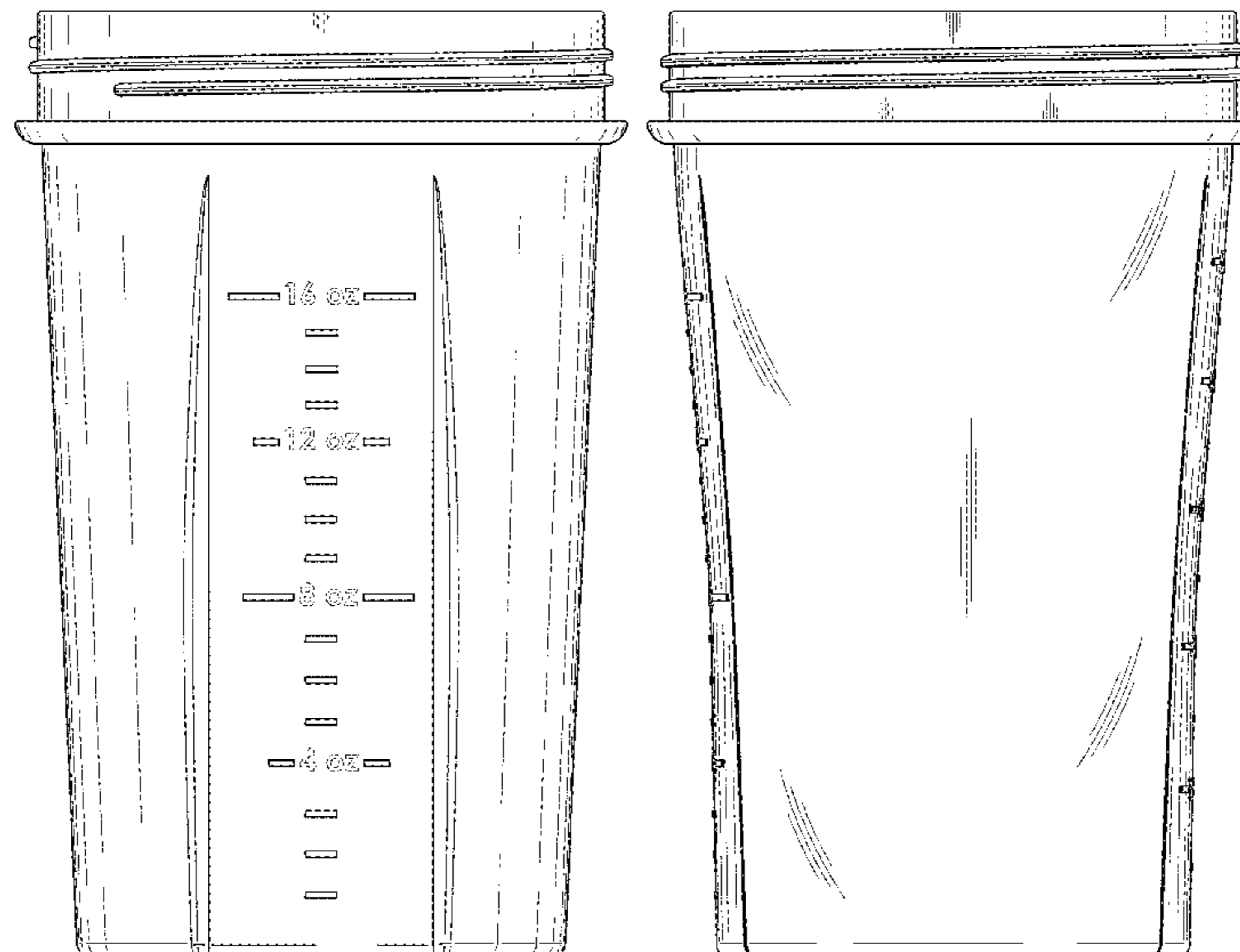

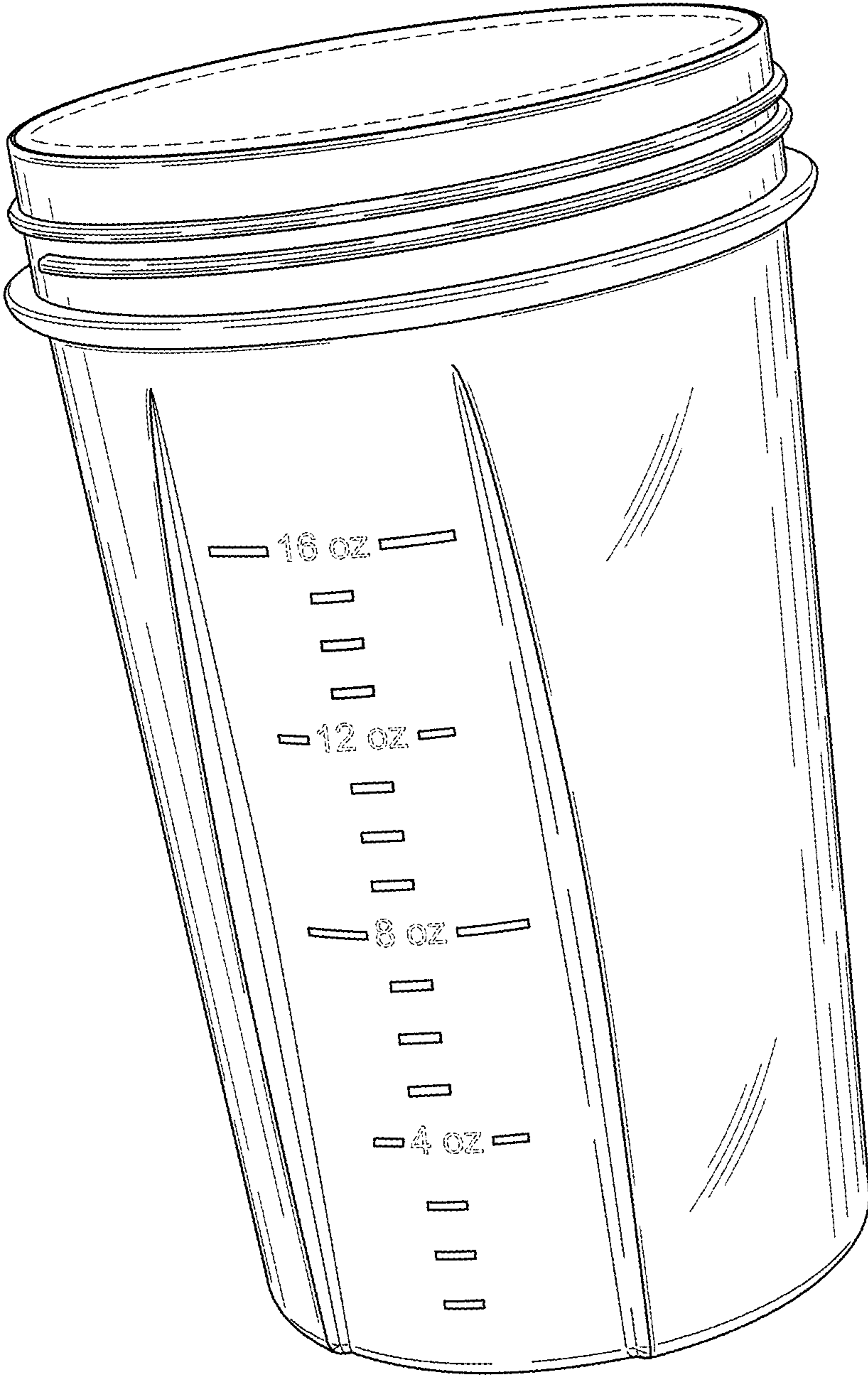

FIG. 1

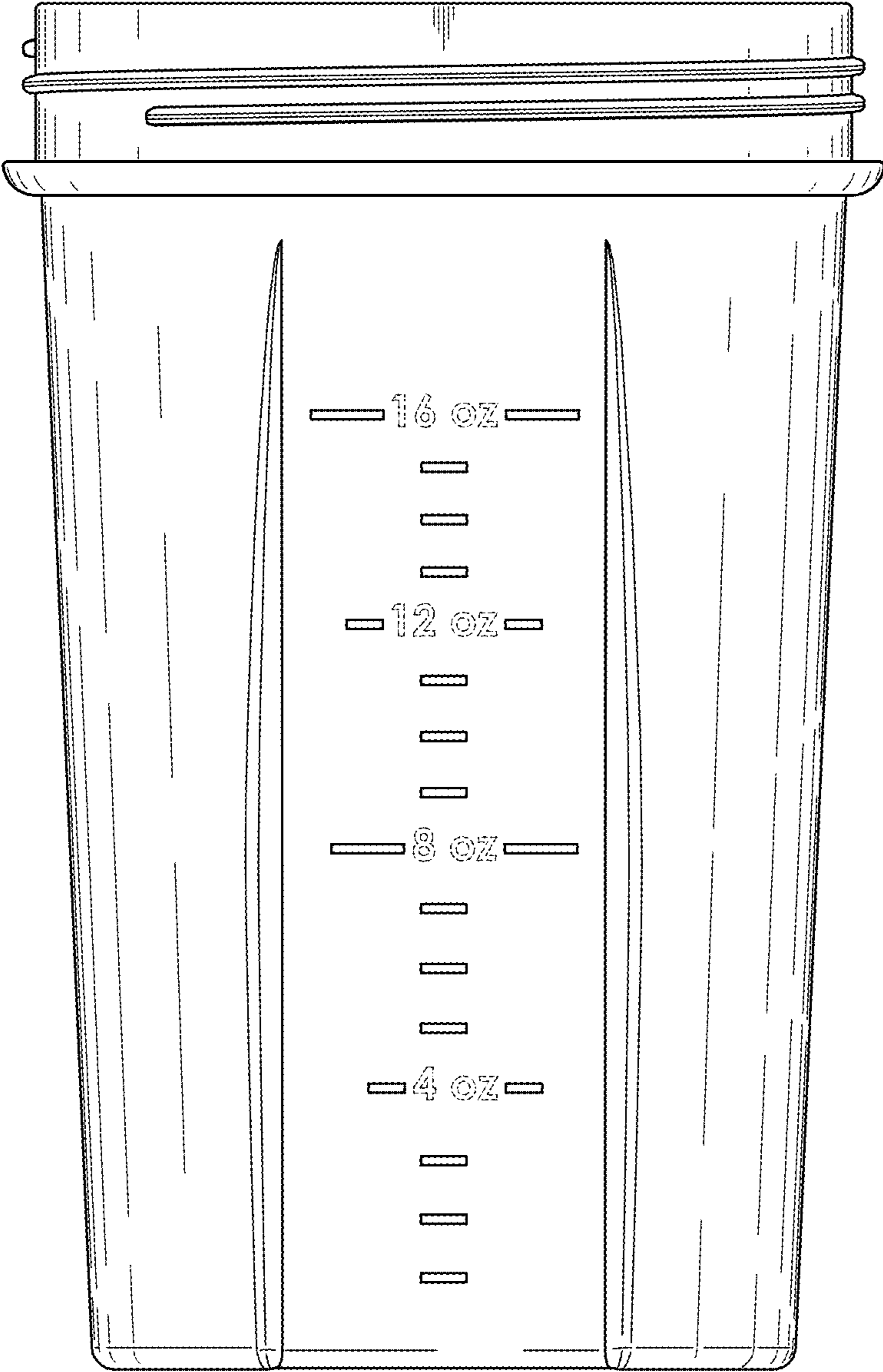

FIG. 2

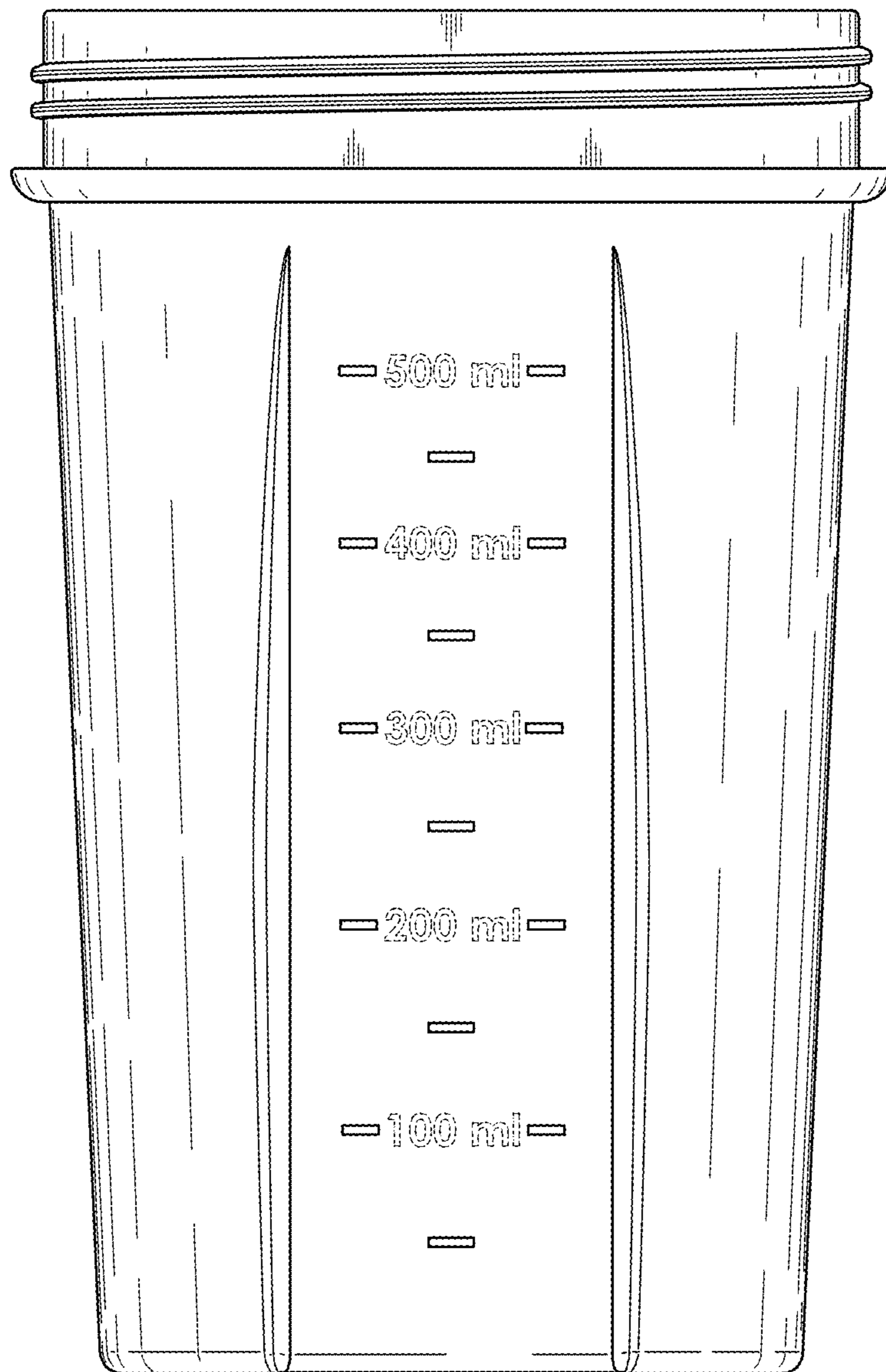

FIG. 3

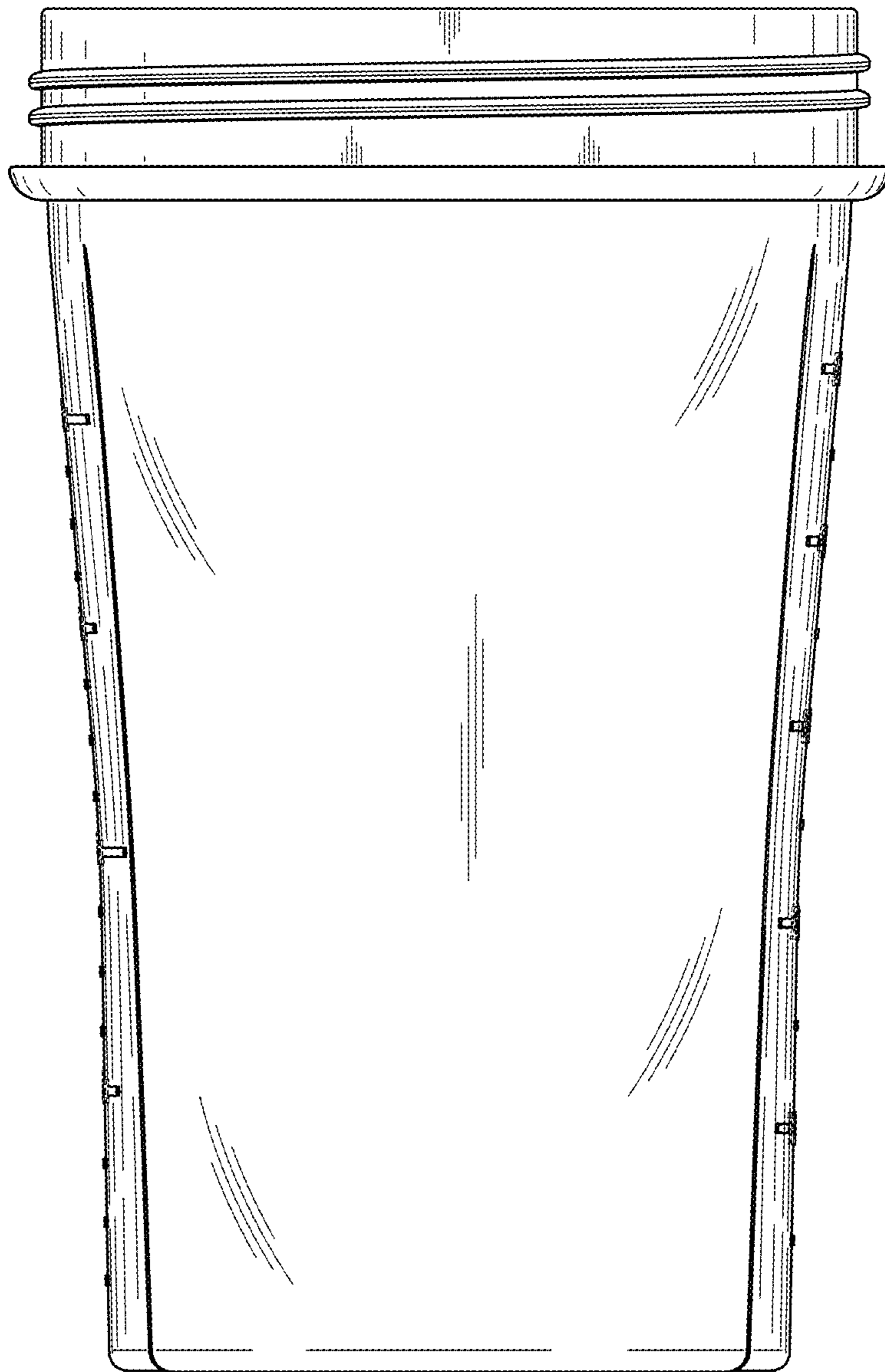

FIG. 4

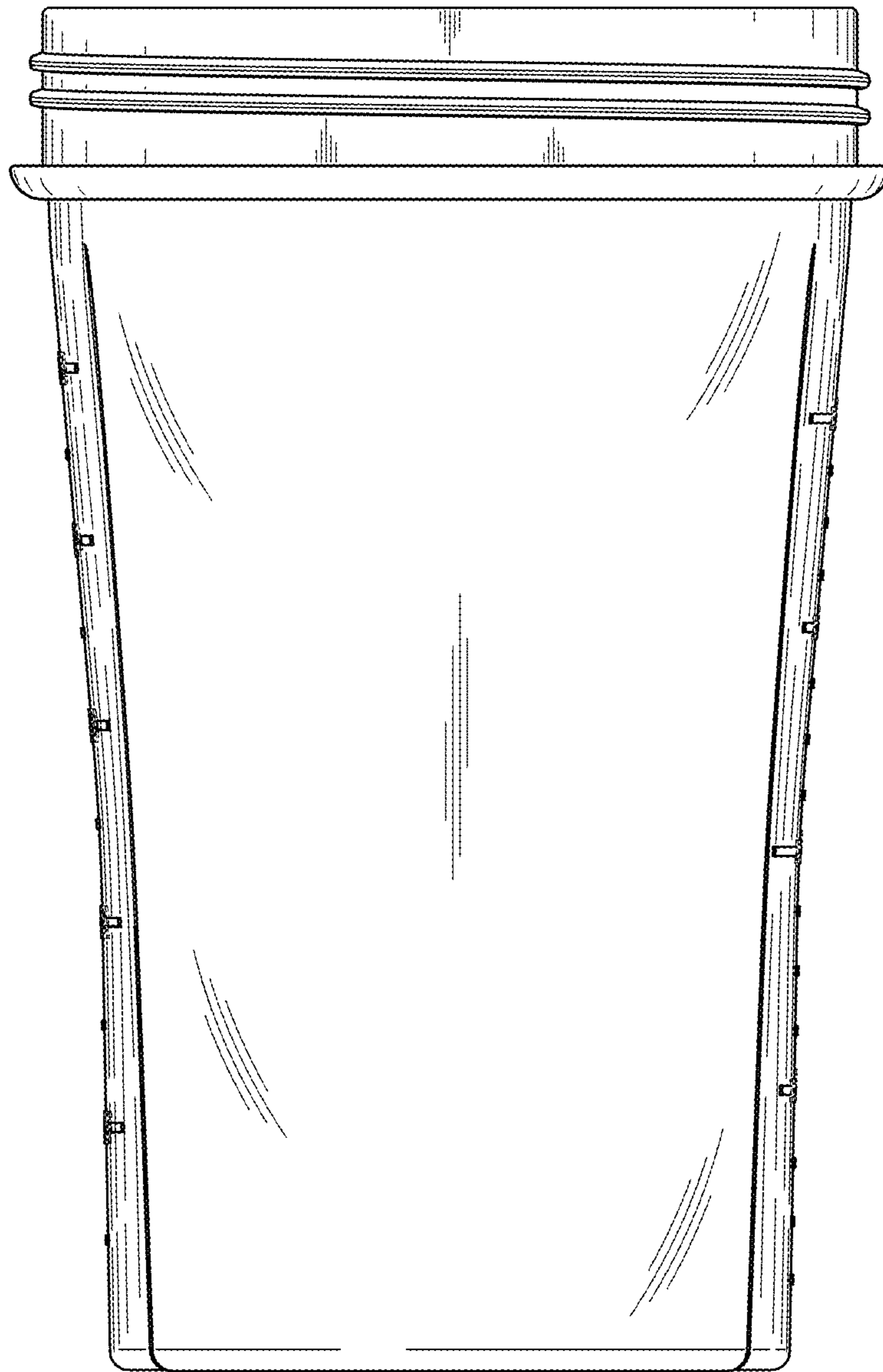

FIG. 5

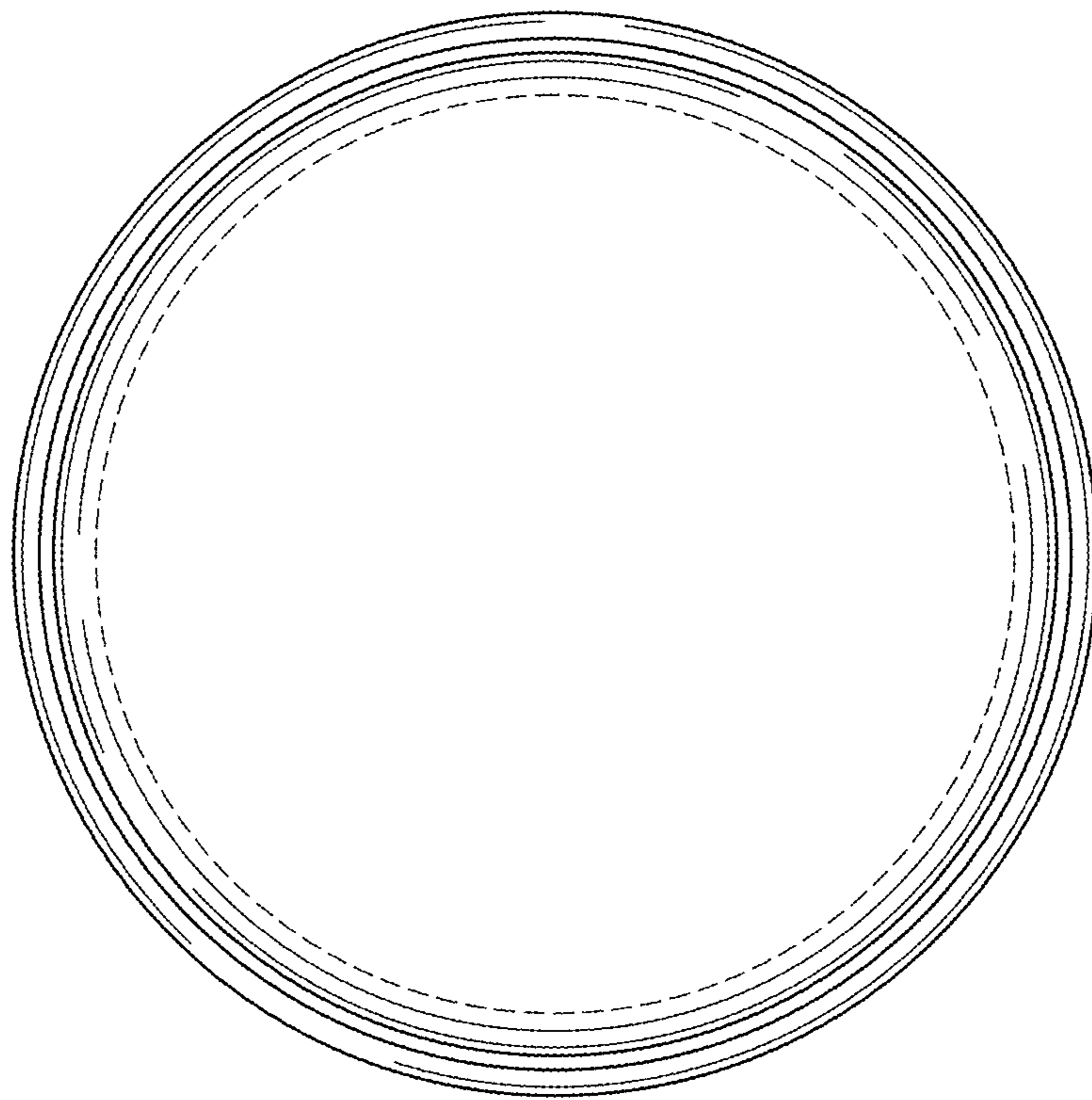

FIG. 6

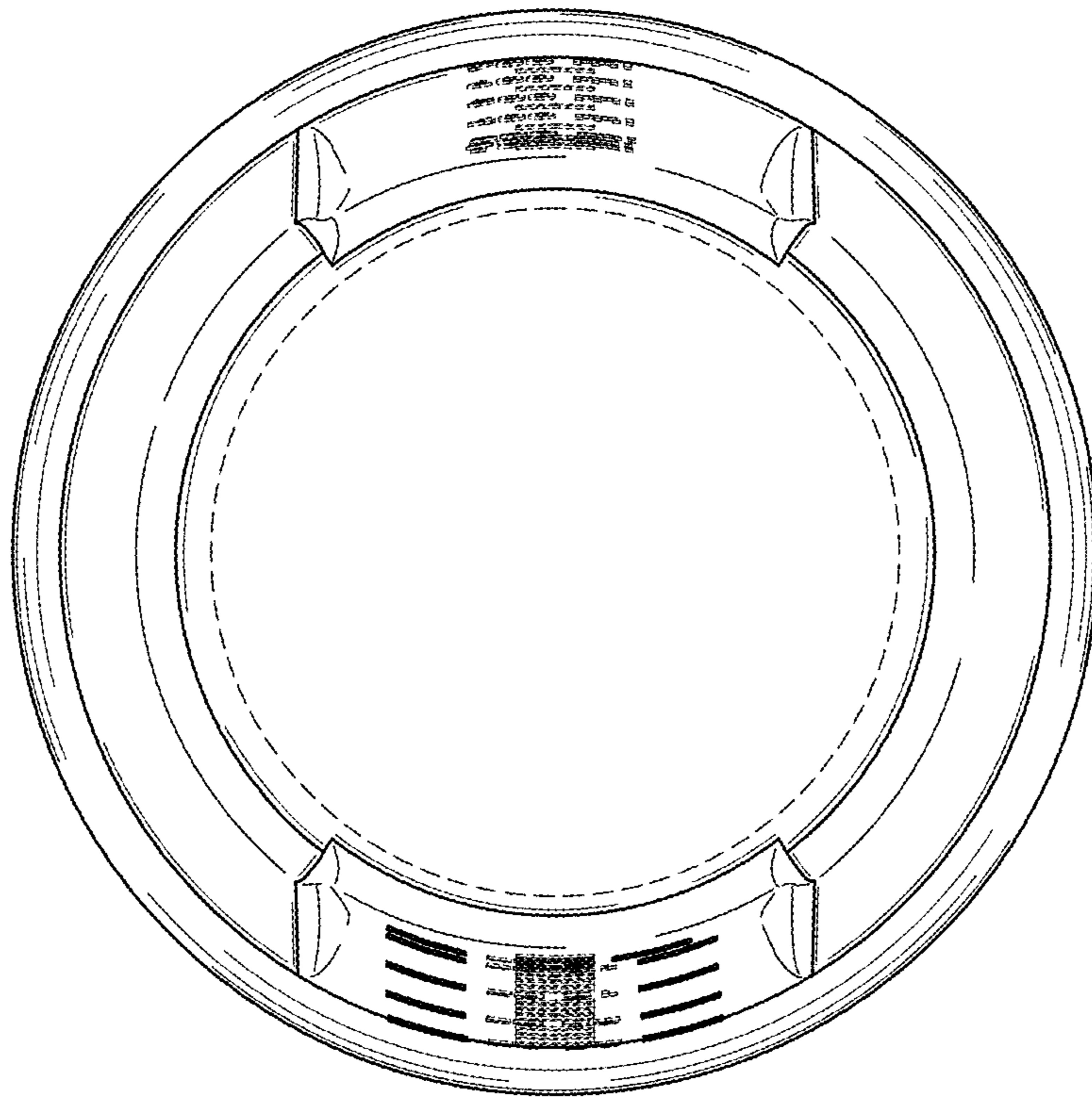

FIG. 7