



US00D804908S

(12) **United States Design Patent**
Di Giuseppantonio

(10) **Patent No.:** **US D804,908 S**
(45) **Date of Patent:** **** Dec. 12, 2017**

(54) **GOBLET**

(71) Applicant: **BORMIOLI LUIGI S.p.A.**, Parma (IT)

(72) Inventor: **Vincenzo Di Giuseppantonio**, Fidenza (IT)

(73) Assignee: **BORMIOLI LUIGI S.P.A.**, Parma (IT)

(**) Term: **15 Years**

(21) Appl. No.: **29/557,211**

(22) Filed: **Mar. 7, 2016**

(30) **Foreign Application Priority Data**

Sep. 8, 2015 (EM) 002768077

(51) **LOC (10) Cl.** **07-01**

(52) **U.S. Cl.**
USPC **D7/524; D7/537**

(58) **Field of Classification Search**
USPC D7/507, 509, 524-528, 537, 300.2, 700;
D27/118, 163; 220/592.16, 592.17, 628,
220/669; D9/712

CPC . B41P 2217/61; A47G 19/22; A47G 19/2205;
A47G 23/03; A47G 19/12

See application file for complete search history.

(56) **References Cited**

U.S. PATENT DOCUMENTS

D370,155 S *	5/1996	Harrison	D7/524
D370,597 S *	6/1996	Hoffer	D7/525
D497,773 S *	11/2004	Riedel	D7/524
D655,985 S *	3/2012	Roberts	D7/524

OTHER PUBLICATIONS

Riedel wine glass guide—Grape Champagne Glass 2006.*
Riedel Sommeliers Champagne Flute 2015—http://www.williams-sonoma.com/products/3881216/?catalogId=5&sku=3881216&cm_ven=Shopping&cm_cat=Polyvore&cm_pla=default&cm_ite=default#reviews.*

* cited by examiner

Primary Examiner — Marianne Pandozzi

Assistant Examiner — Jae Liang

(74) *Attorney, Agent, or Firm* — Hedman & Costigan, P.C.; James V. Costigan; Kathleen A. Costigan

(57) **CLAIM**

I claim the ornamental design for a goblet, as shown and described.

DESCRIPTION

FIG. 1 is a perspective view of a goblet showing my new design;

FIG. 2 is a front elevational view thereof; the rear, right side, and left side elevational views being a mirror image thereof;

FIG. 3 is a top plan view thereof;

FIG. 4 is a bottom plan view thereof; and,

FIG. 5 is a cross section view showing a section taken along line 5-5 of FIG. 2.

1 Claim, 4 Drawing Sheets

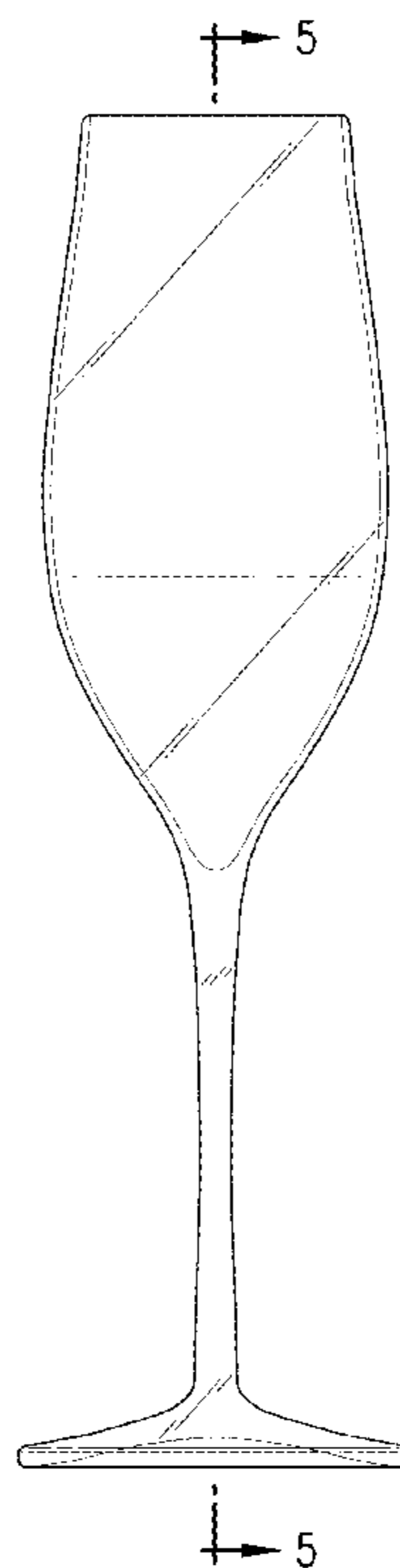
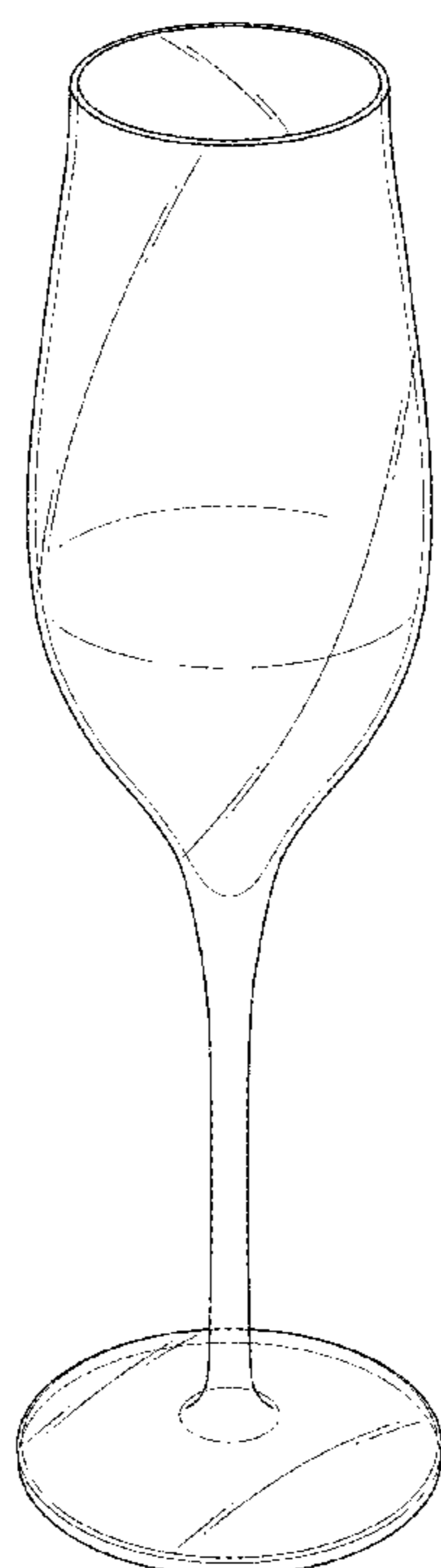

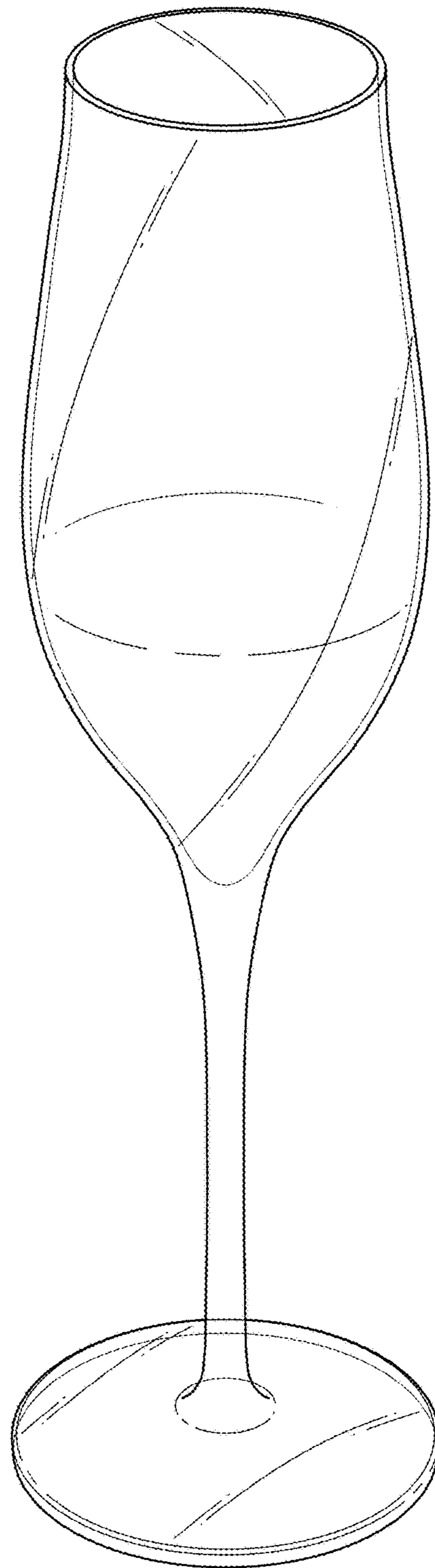

FIG. 1

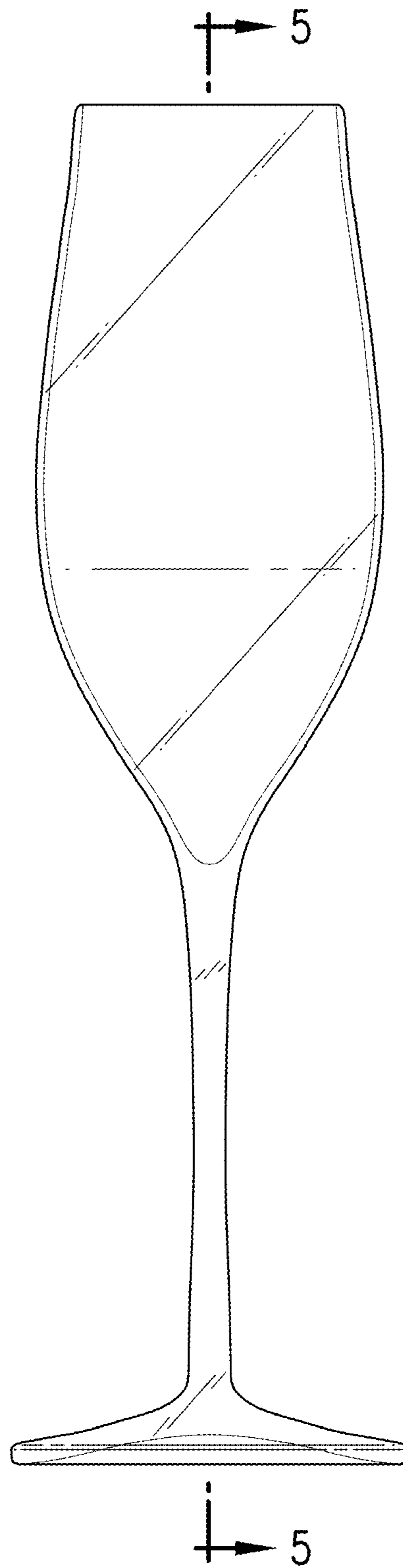

FIG. 2

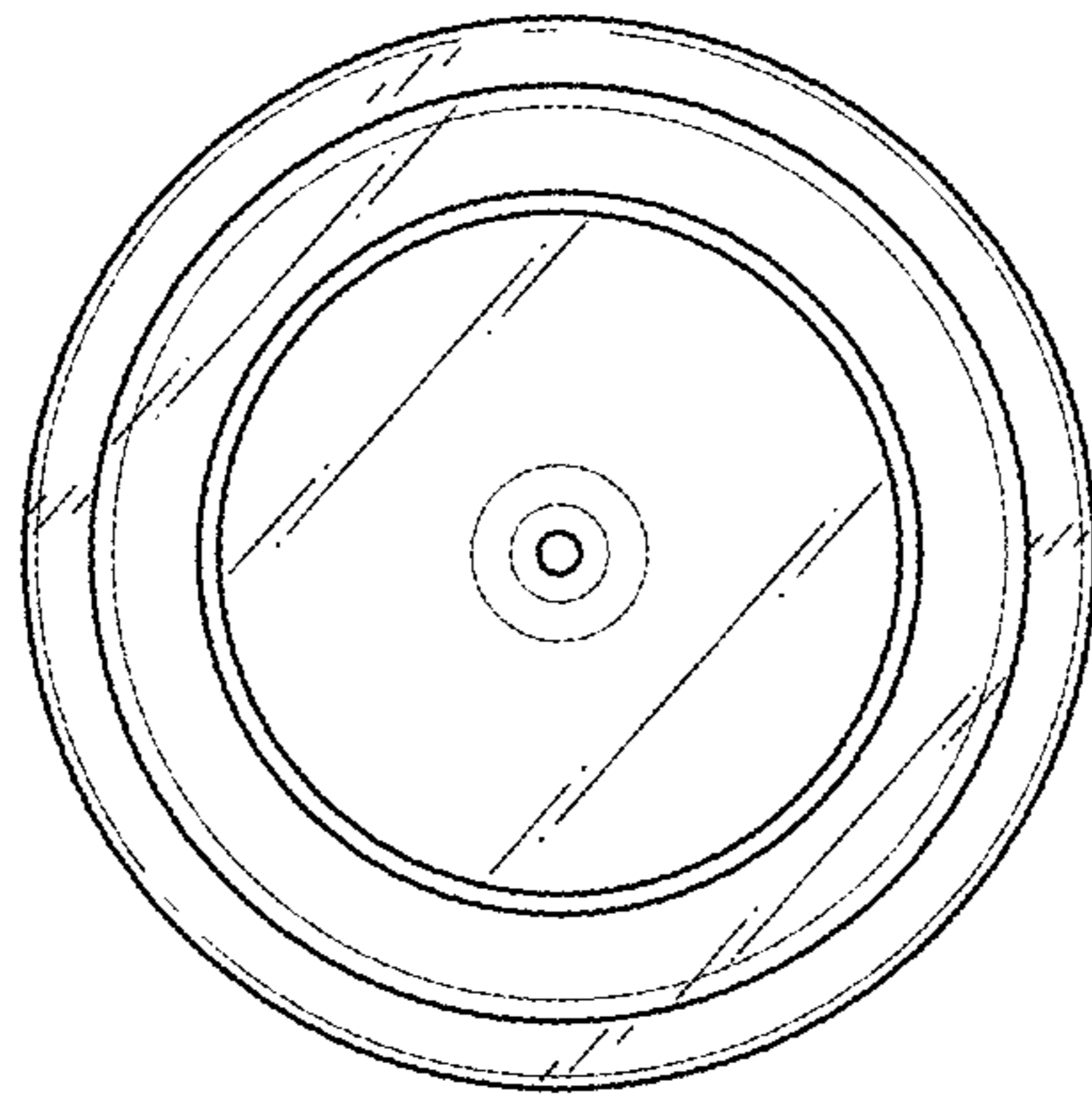

FIG. 3

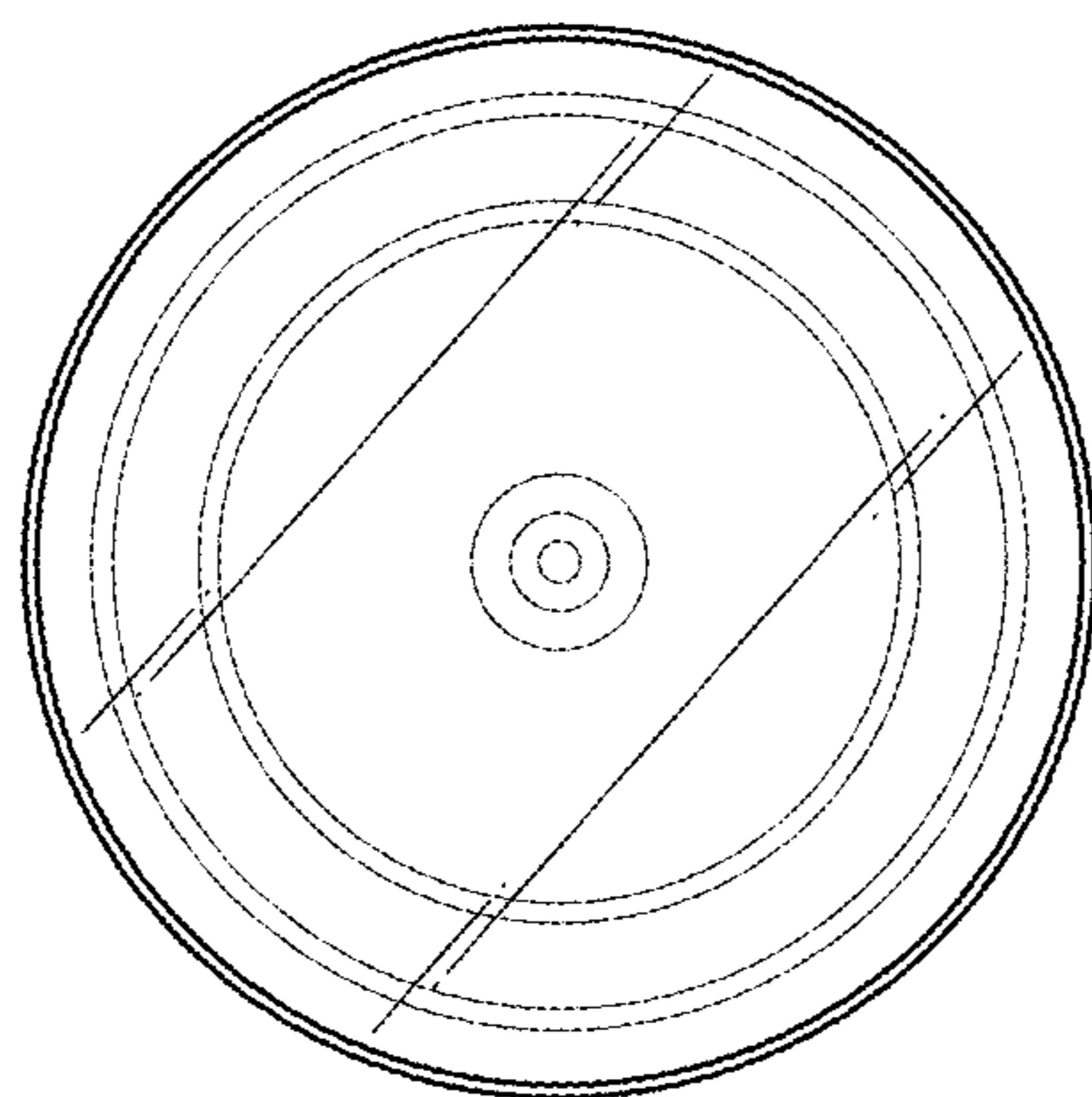

FIG. 4

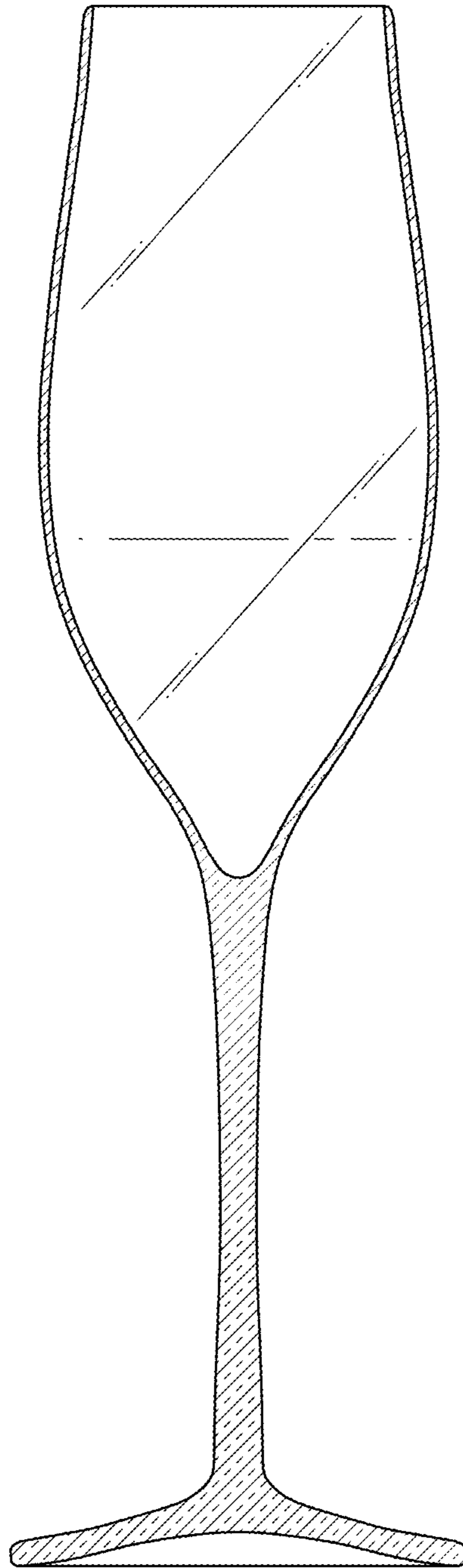

FIG. 5