

US00D804853S

(12) **United States Design Patent**
Wightman

(10) **Patent No.:** **US D804,853 S**

(45) **Date of Patent:** **** Dec. 12, 2017**

- (54) **PILLOW TOP MATTRESS**
- (71) Applicant: **SERTA, INC.**, Hoffman Estates, IL
(US)
- (72) Inventor: **Leona Wightman**, Dade City, FL (US)
- (73) Assignee: **SERTA, INC.**, Hoffman Estates, IL
(US)
- (**) Term: **15 Years**
- (21) Appl. No.: **29/546,596**
- (22) Filed: **Nov. 24, 2015**
- (51) **LOC (10) Cl.** **06-09**
- (52) **U.S. Cl.**
USPC **D6/605**
- (58) **Field of Classification Search**
USPC D6/582-583, 587-592, 595-613,
D6/617-622; D21/803-809; D24/183
CPC A47G 9/00; A47G 2009/001; A47G
2009/002; A47G 2009/003; A47G
2009/005; A47G 2009/006; A47G 9/02;
A47G 9/0207; A47G 9/0215; A47G
9/0223; A47G 9/023; A47G 9/0238;
A47G 9/0246; A47G 9/0253; A47G
9/0261; A47G 9/06; A47G 9/062; A47G
9/066; A47G 9/068; A47G 9/08; A47G
2009/0276; A47G 9/0284; A47G 9/0292;
A47G 9/04; A47G 9/10
See application file for complete search history.

- 5,782,190 A * 7/1998 Porter D05B 11/005
112/176
- 6,108,835 A * 8/2000 Hwang A47C 27/084
5/420
- D621,197 S * 8/2010 Gladney D6/605
- 7,886,385 B2 * 2/2011 Carlitz A47C 27/002
5/500
- D649,386 S * 11/2011 Freese D6/605
- D662,753 S * 7/2012 Shive D6/605
- D663,152 S * 7/2012 Shive D6/605
- D670,953 S * 11/2012 Price D6/605

(Continued)

Primary Examiner — Mary Ann Calabrese
Assistant Examiner — Jennifer L Rempfer
(74) *Attorney, Agent, or Firm* — Cantor Colburn LLP

(57) **CLAIM**

I claim the ornamental design for a pillow top mattress, as shown and described.

DESCRIPTION

FIG. 1 is a left side, top perspective view of a pillow top mattress embodying my design;
FIG. 2 is a top plan view thereof;
FIG. 3 is a left side view thereof, the right side being a mirror image thereof;
FIG. 4 is a foot end view thereof, the head end being a mirror image thereof;
FIG. 5 is a bottom plan view thereof in its intended environment;
FIG. 6 is an enlarged perspective view taken from FIG. 1 showing a portion of the pillow top mattress; and,
FIG. 7 is an enlarged side view taken from FIG. 3 showing a portion of the pillow top mattress.
The broken line boundaries are environmental and form no part of the claimed design. Accordingly, the broken lines in FIGS. 1, 3, 4, and 5 showing a mattress foundation illustrates the environment and forms no part of the design. The broken lines in FIGS. 6 and 7 showing the boundaries of an enlarged detailed view form no part of the design.

1 Claim, 5 Drawing Sheets

(56) **References Cited**

U.S. PATENT DOCUMENTS

- 1,721,396 A * 7/1929 Humphris E04F 13/045
52/526
- D341,052 S * 11/1993 Fogel D6/596
- 5,501,164 A * 3/1996 Porter D05B 11/005
112/176

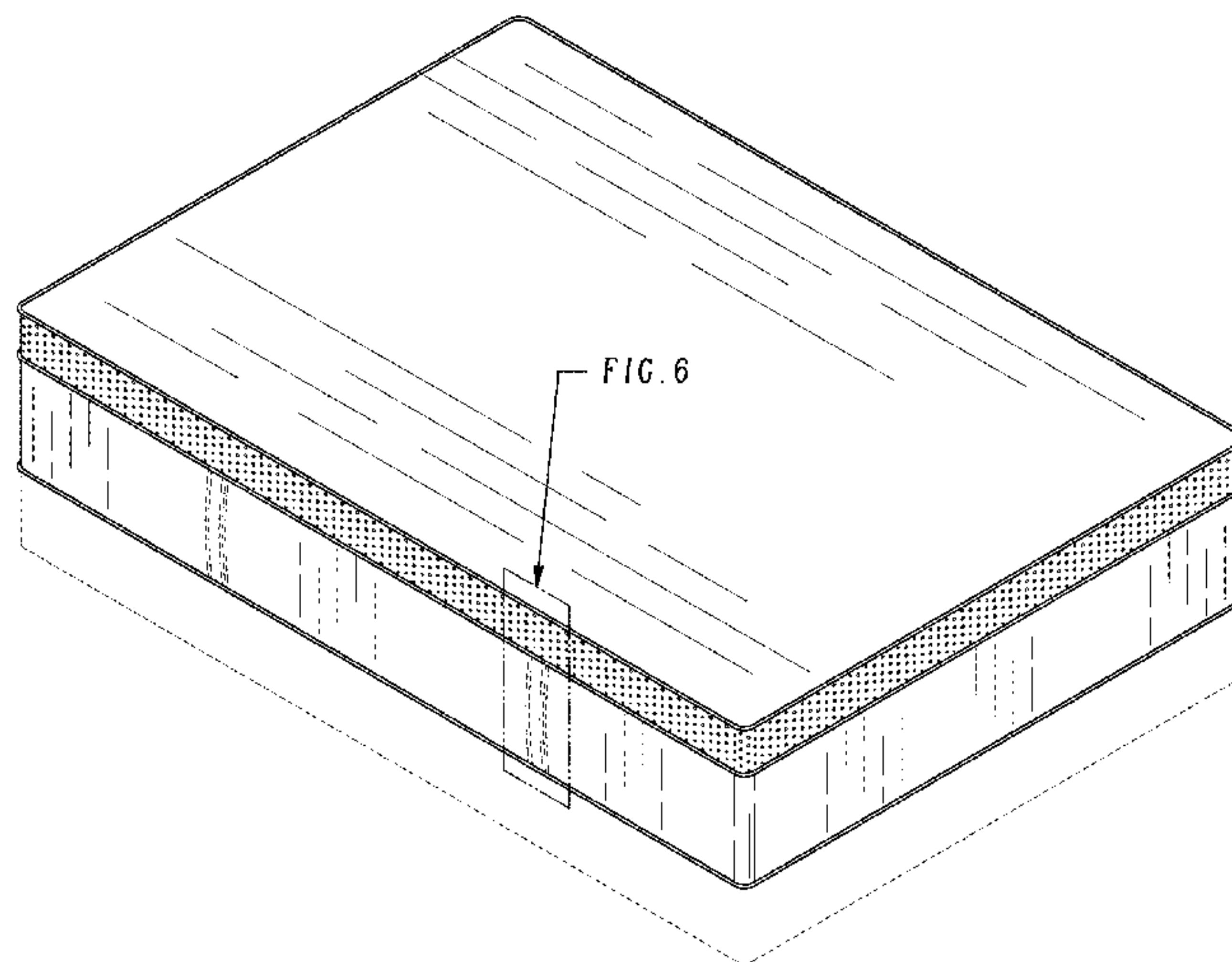

(56)

References Cited

U.S. PATENT DOCUMENTS

D715,075	S	*	10/2014	Hughes	D6/605
D717,079	S	*	11/2014	Bradford	D6/605
D731,819	S	*	6/2015	Wightman	D6/605
D744,767	S	*	12/2015	Morrison	D6/605
D773,209	S	*	12/2016	Jaigobin	D6/596
D782,221	S	*	3/2017	Wightman	D6/605
2012/0297547	A1	*	11/2012	Myers	D05B 11/005 5/737

* cited by examiner

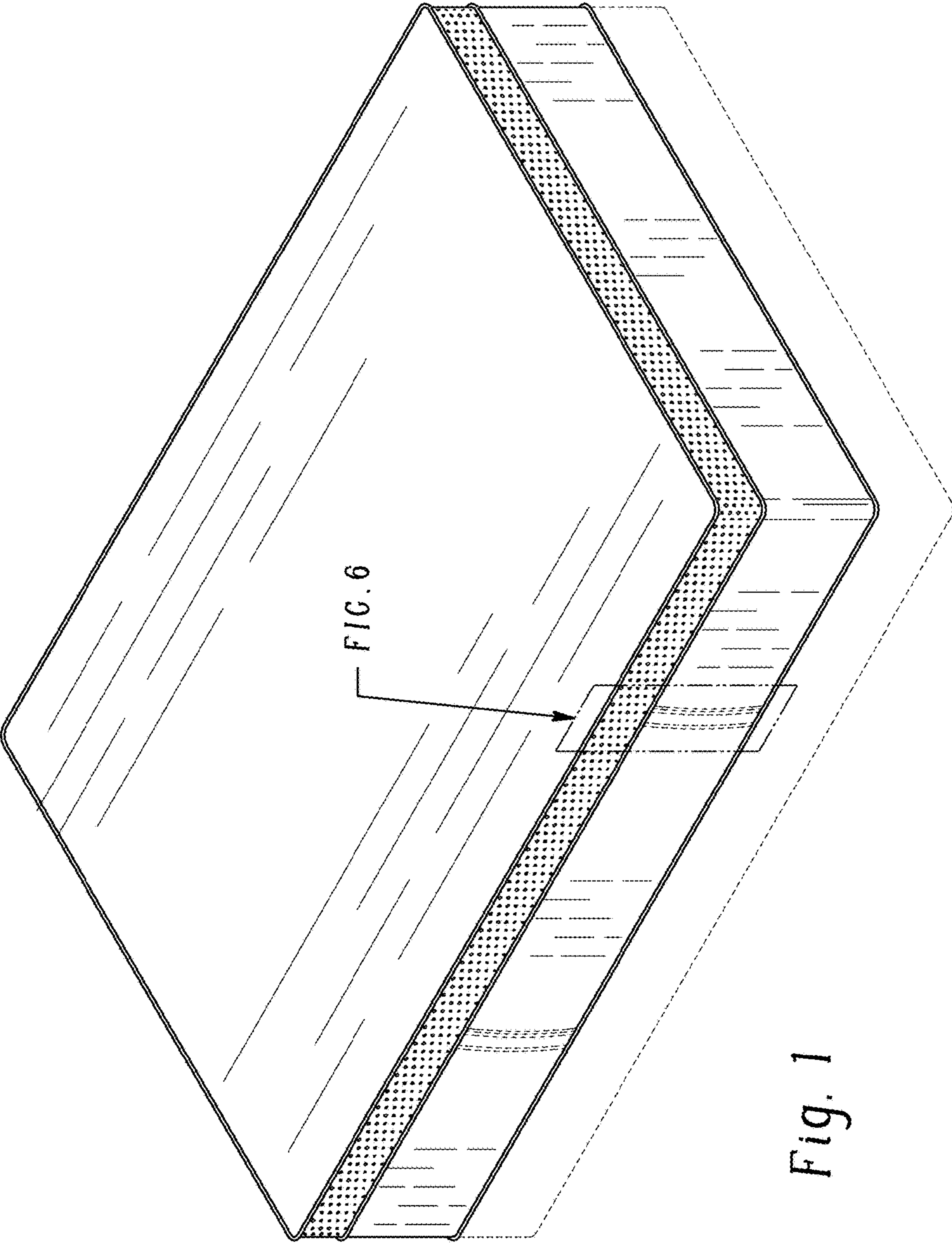

Fig. 1

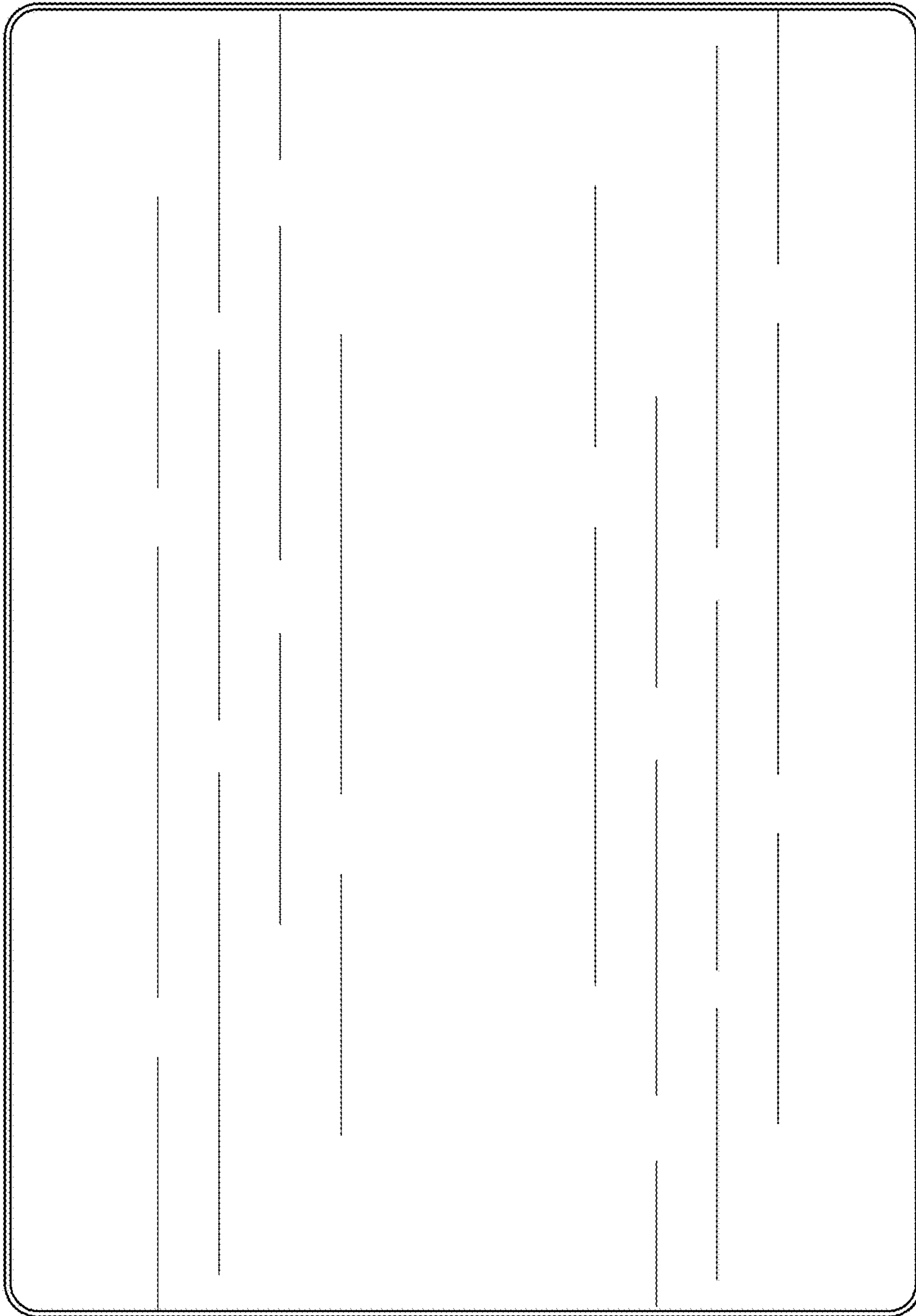

Fig. 2

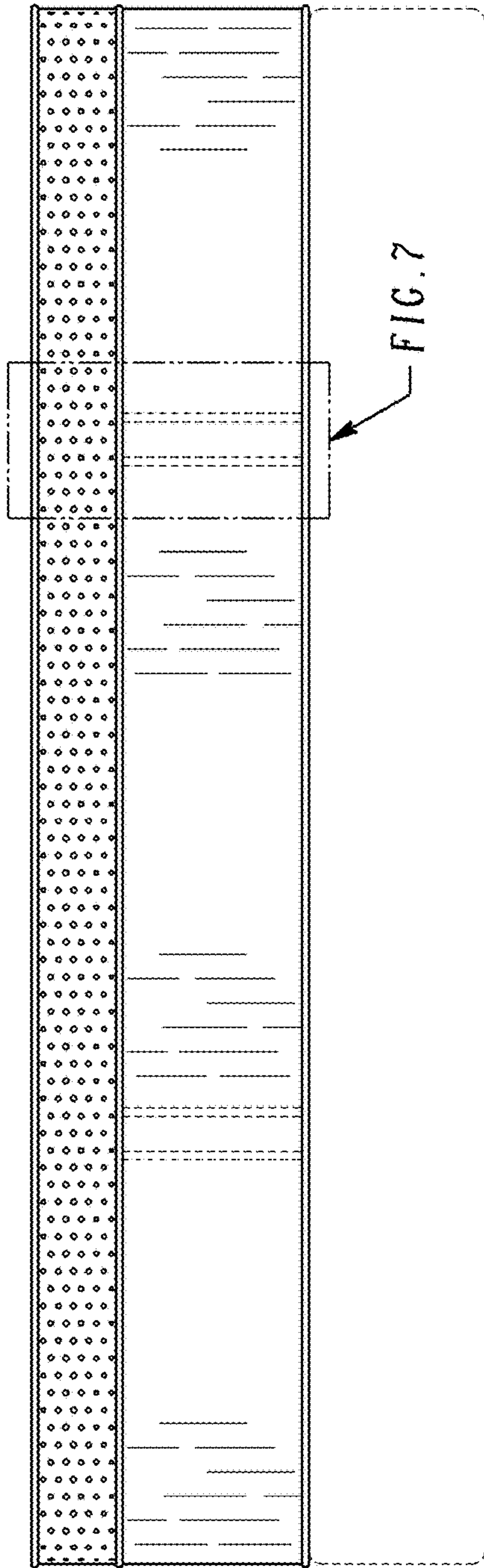

Fig. 3

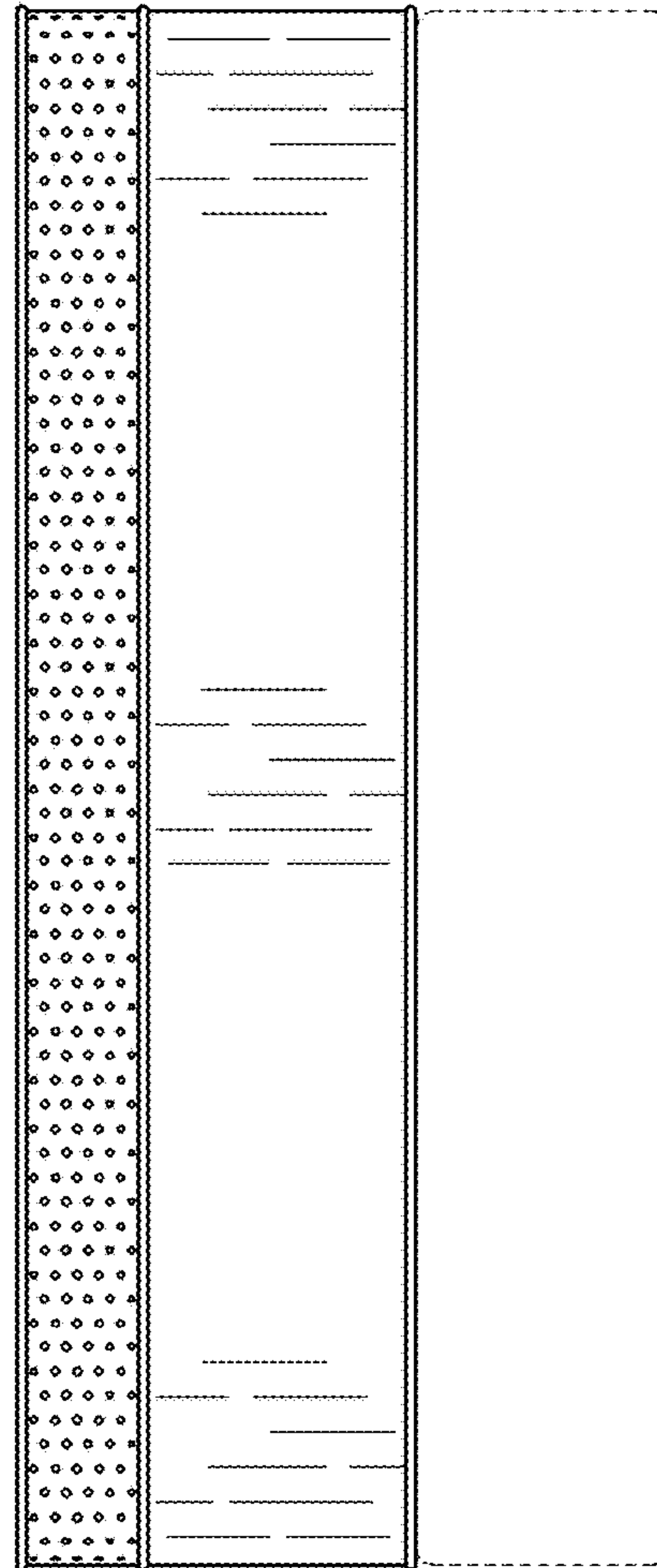

Fig. 4

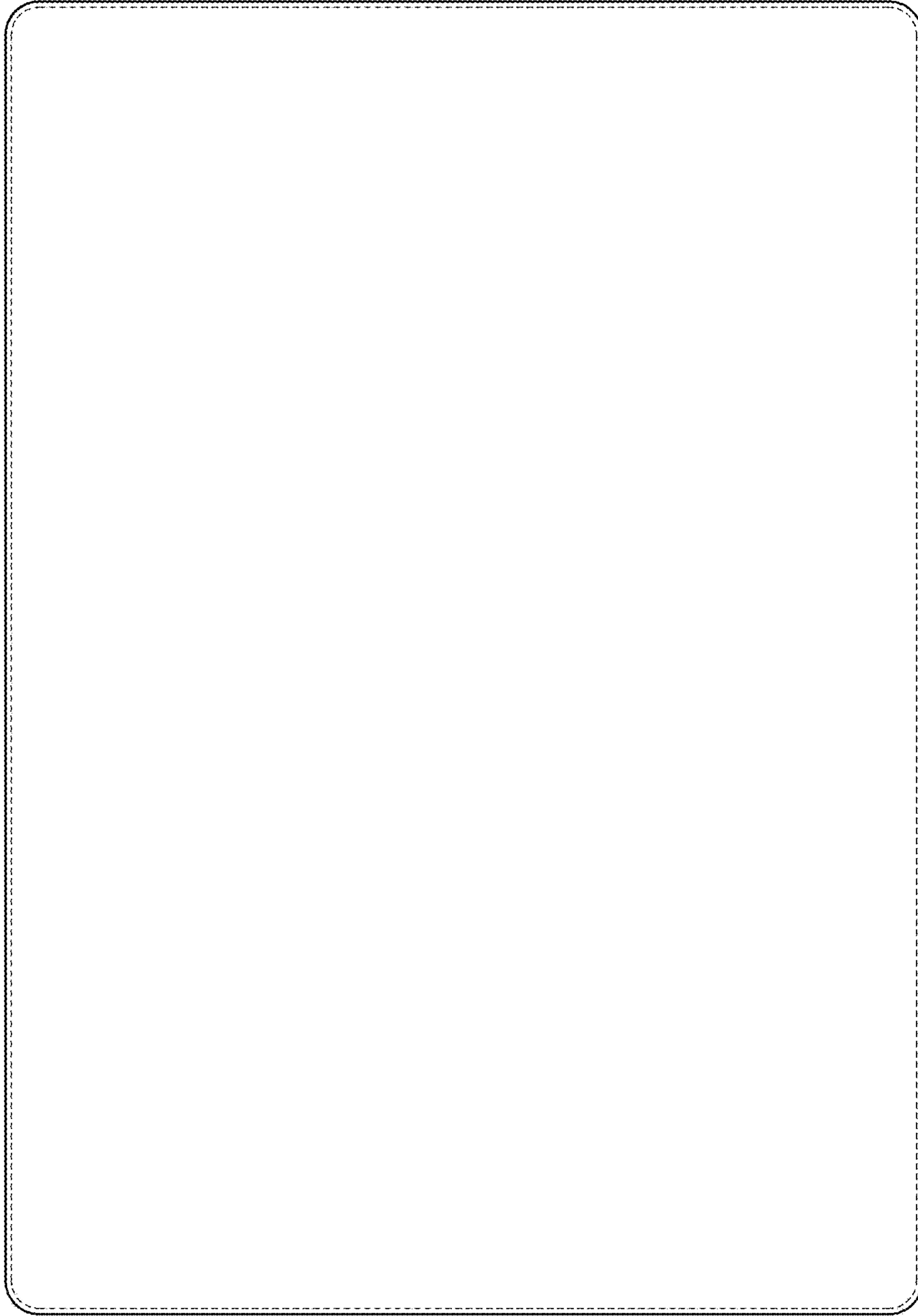

Fig. 5

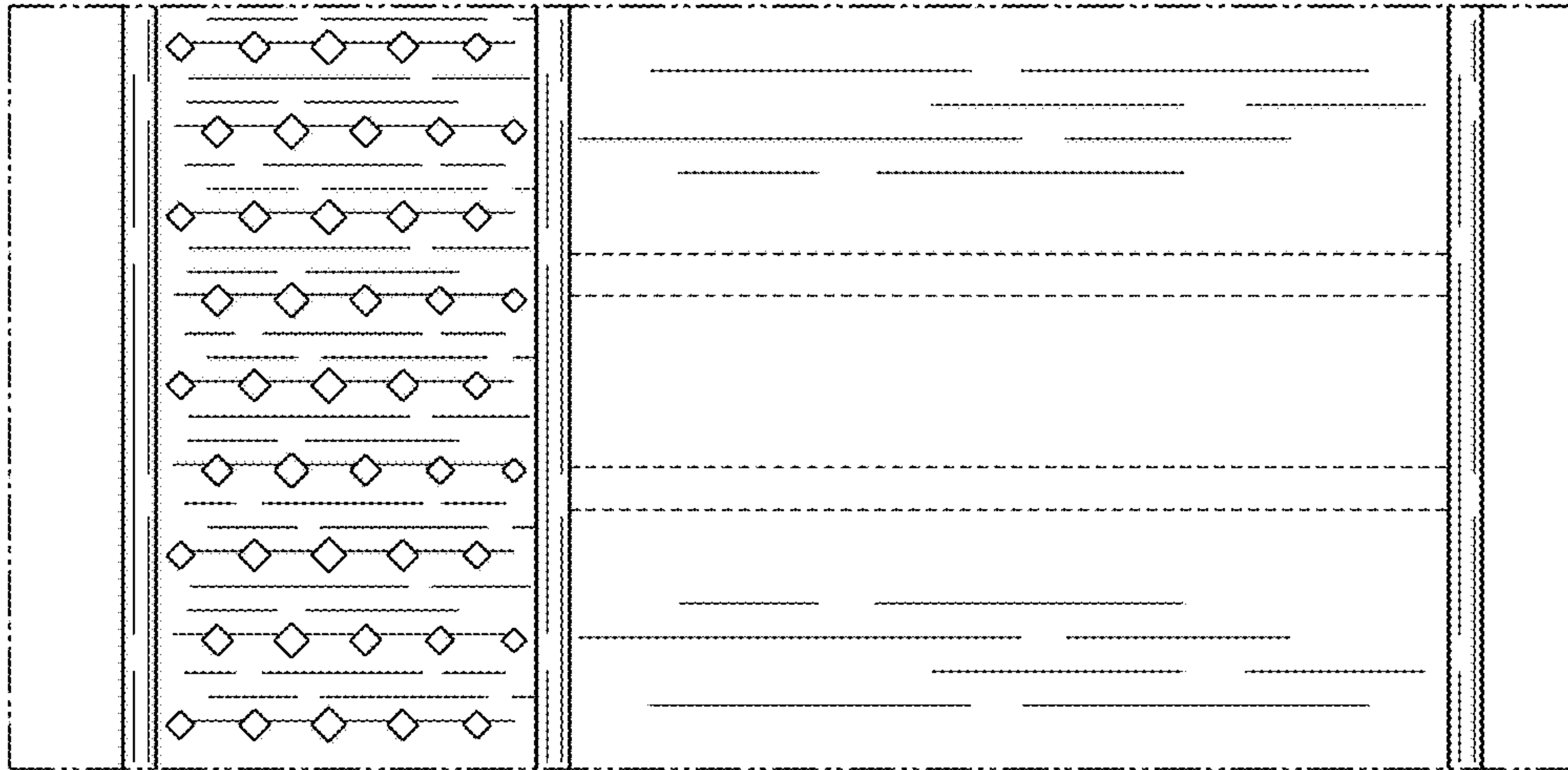

Fig. 7

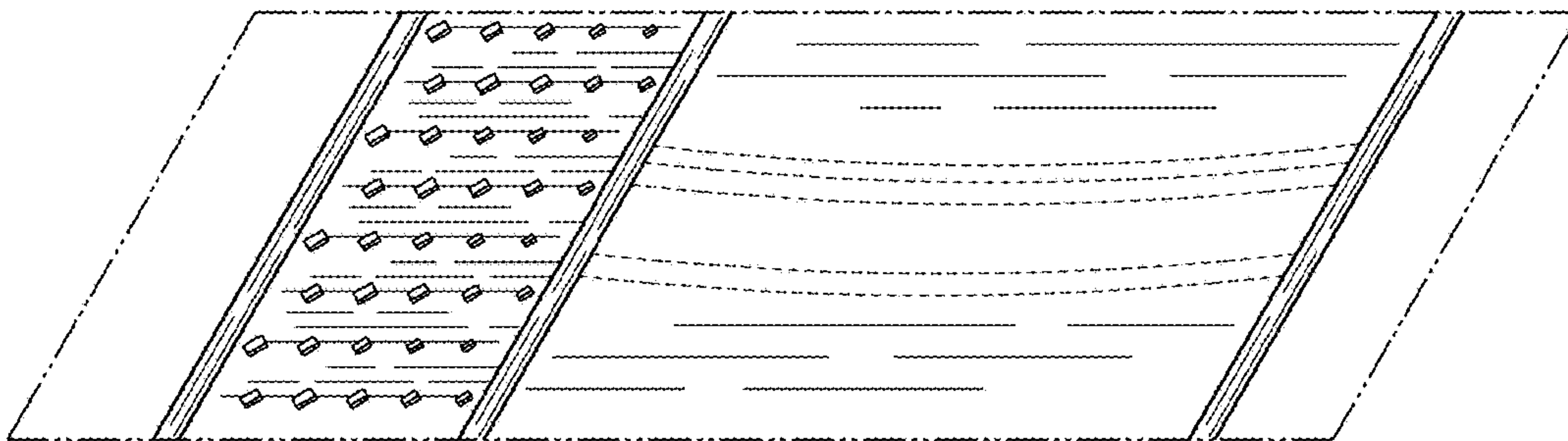

Fig. 6