

US00D804826S

(12) **United States Design Patent** (10) **Patent No.:** **US D804,826 S**
Kling et al. (45) **Date of Patent:** **** Dec. 12, 2017**

(54) **BRUSH ATTACHMENT FOR A BEAUTY CARE DEVICE**

(71) Applicant: **Braun GmbH**, Kronberg (DE)

(72) Inventors: **Björn Kling**, Glashuetten (DE); **Britta Stockinger**, Frankfurt (DE)

(73) Assignee: **Braun GmbH**, Kronberg (DE)

(**) Term: **15 Years**

(21) Appl. No.: **29/576,648**

(22) Filed: **Sep. 6, 2016**

Related U.S. Application Data

(62) Division of application No. 29/428,325, filed on Jul. 30, 2012, now Pat. No. Des. 768,391.

Foreign Application Priority Data

Jan. 31, 2012 (WO) 650383901

(51) **LOC (10) Cl.** **04-01**

(52) **U.S. Cl.**
USPC **D4/127**

Field of Classification Search

USPC D4/100, 102, 127, 132, 134, 136, 138;
D24/146, 200, 214, 215; D28/58, 63
CPC .. A46B 3/00; A46B 3/005; A46B 3/22; A46B
5/0095; A46B 7/00; A46B 7/04; A46B
7/042; A46B 7/06; A46B 7/08; A46B
9/00; A46B 9/005; A46B 9/02; A46B
9/06; A46B 13/00; A46B 13/008; A46B
13/02; A46B 13/023; A46B 13/026; A46B
13/04; A46B 13/08; A46B 15/0002; A46B
15/0022; A46D 1/00; A47K 7/00; A47K
7/02; A47K 7/04; A47K 7/043; A47L
23/06; A61H 7/00; A61H 7/003; A61H
7/005; A61H 2205/022

See application file for complete search history.

(56) **References Cited**

U.S. PATENT DOCUMENTS

2,156,514 A 5/1939 Sassano
2,682,675 A 7/1954 Prucha
D245,883 S 9/1977 Tsuji et al.
4,203,431 A 5/1980 Abura et al.
D549,964 S * 9/2007 Roth D4/102
D567,441 S * 4/2008 Kling D28/44.1
D601,803 S * 10/2009 Reishus D4/102
7,789,092 B2 * 9/2010 Akridge A61B 17/50
132/200
D646,487 S * 10/2011 Leppla D4/102
(Continued)

FOREIGN PATENT DOCUMENTS

EP 2245957 A1 11/2010
KR 210671 S 4/1998
(Continued)

Primary Examiner — Cathron Brooks
Assistant Examiner — Aula Soroush

(74) *Attorney, Agent, or Firm* — Ronald T. Sia; Kevin C. Johnson; Steven W. Miller

(57) **CLAIM**

The ornamental design for a brush attachment for a beauty care device, as shown and described.

DESCRIPTION

FIG. 1 is a perspective view of an attachment for a brush attachment for a beauty care device;
FIG. 2 is a front view thereof;
FIG. 3 is a right side view thereof;
FIG. 4 is a rear view thereof;
FIG. 5 is a left side view thereof;
FIG. 6 is a top plan view thereof; and,
FIG. 7 is a bottom view thereof.

1 Claim, 4 Drawing Sheets

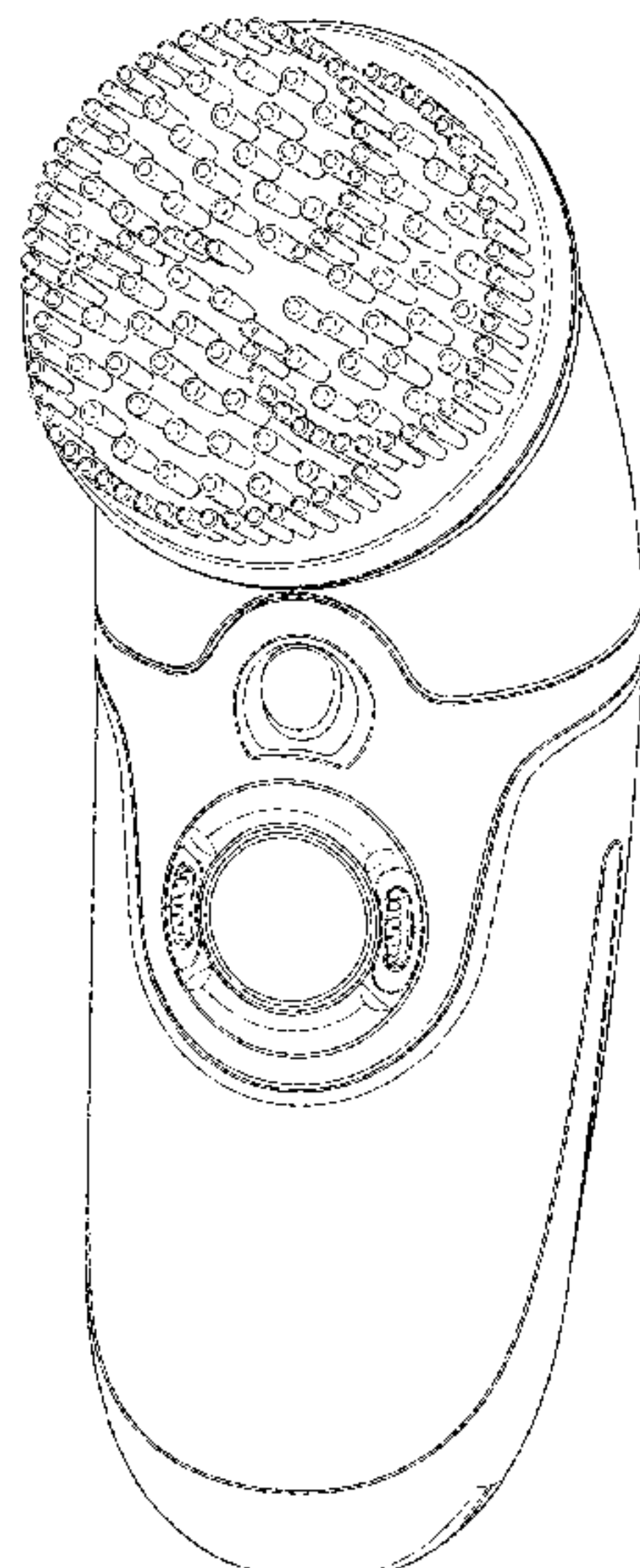

(56)

References Cited

U.S. PATENT DOCUMENTS

D652,168 S * 1/2012 Kling D24/133
D683,139 S * 5/2013 Chikos D4/102
D713,150 S * 9/2014 Maurin D4/102
9,107,486 B2 * 8/2015 Brewer A45D 34/042
9,138,257 B2 * 9/2015 Revivo A61B 17/54
D749,325 S * 2/2016 Middendorp D4/102
D753,399 S * 4/2016 Owen D4/100
D759,256 S * 6/2016 Chen D24/200
D760,498 S * 7/2016 Kim D4/102
D764,706 S * 8/2016 Kling D28/44.1
D768,391 S * 10/2016 Kling D4/127
D773,823 S * 12/2016 Wong D4/102
D776,347 S * 1/2017 Grieshaber D28/44.1
D778,066 S * 2/2017 Kern D4/127
2013/0023806 A1 1/2013 Ungemach et al.

FOREIGN PATENT DOCUMENTS

KR 30-0504630 S 9/2008
WO WO 0156529 A2 8/2001

* cited by examiner

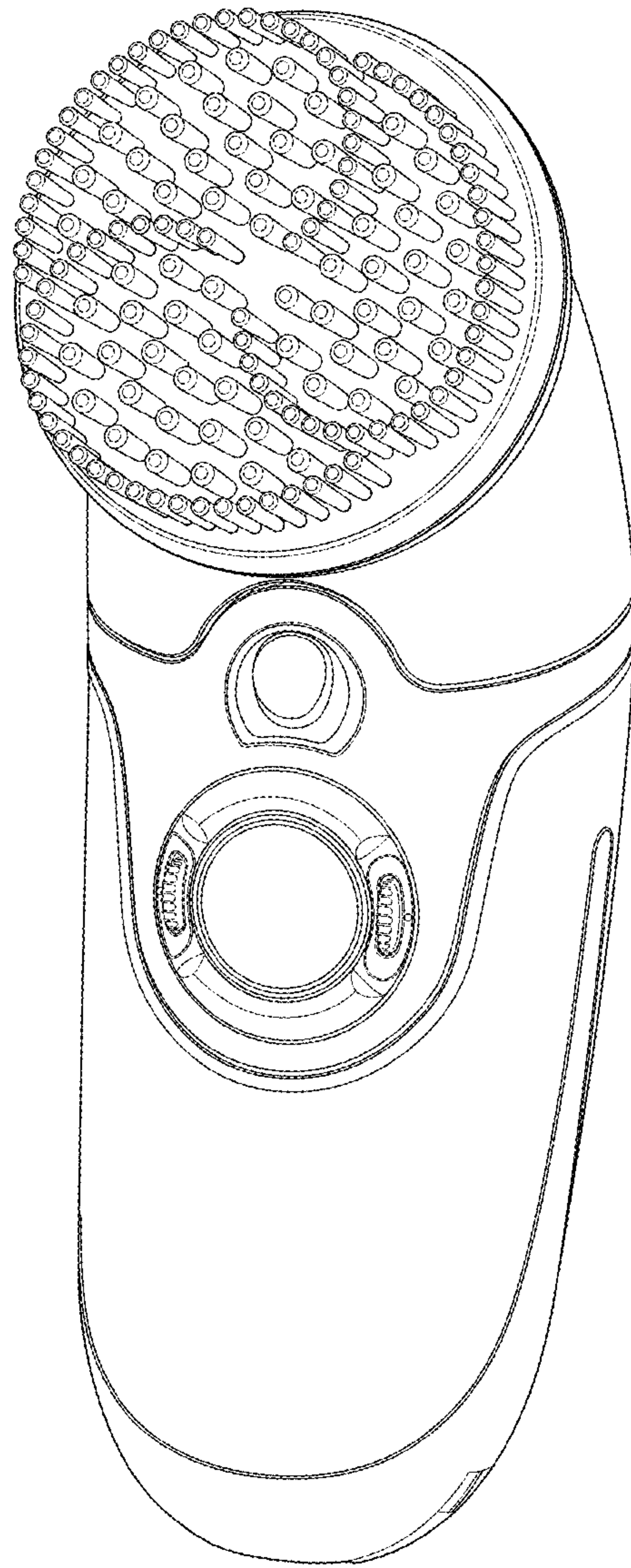

FIG. 1

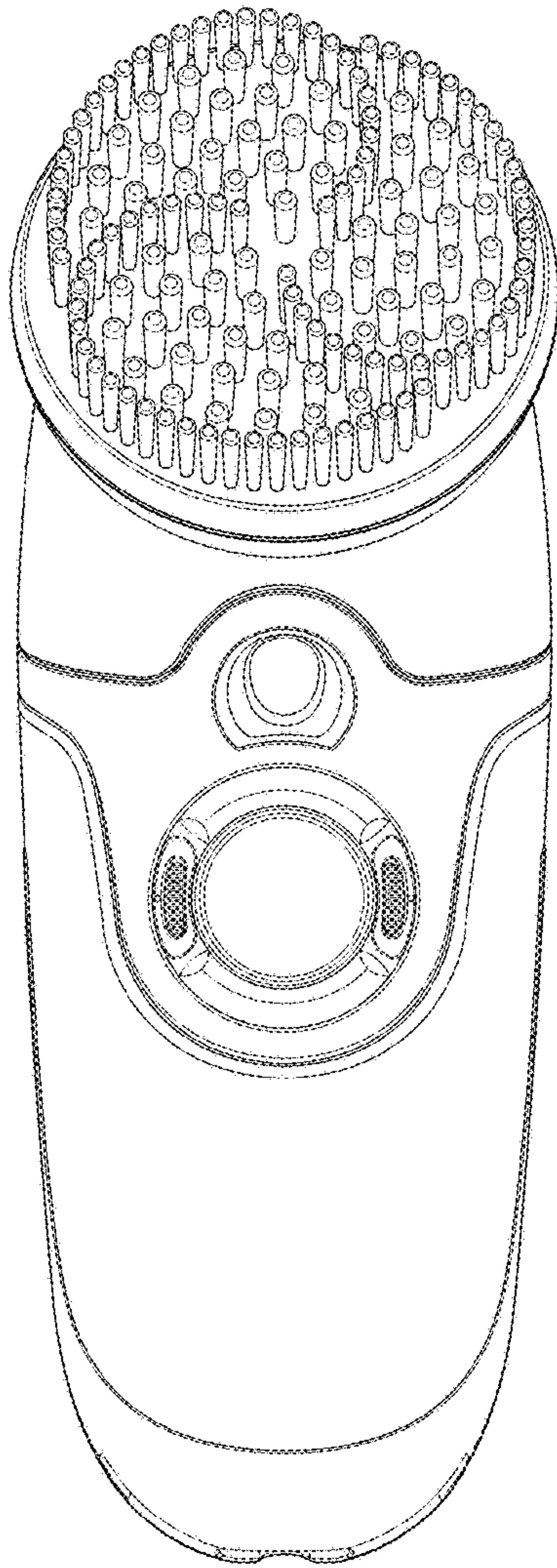

FIG. 2

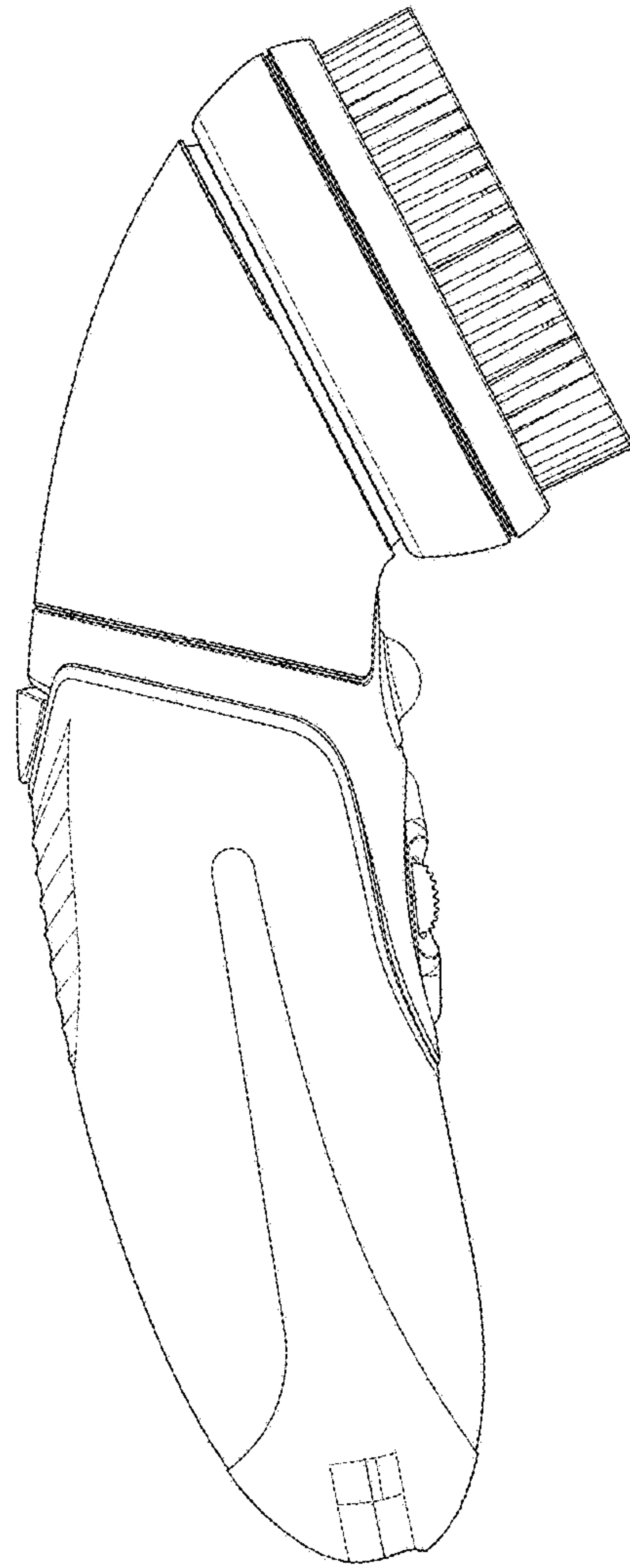

FIG. 3

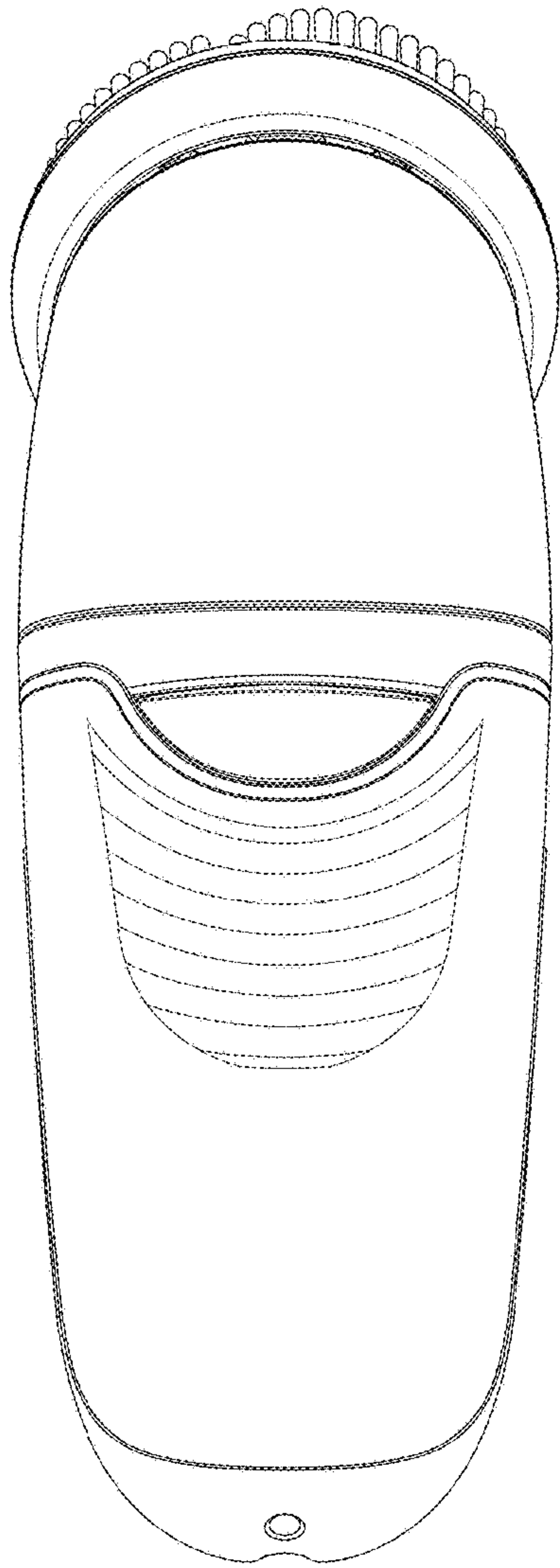

FIG. 4

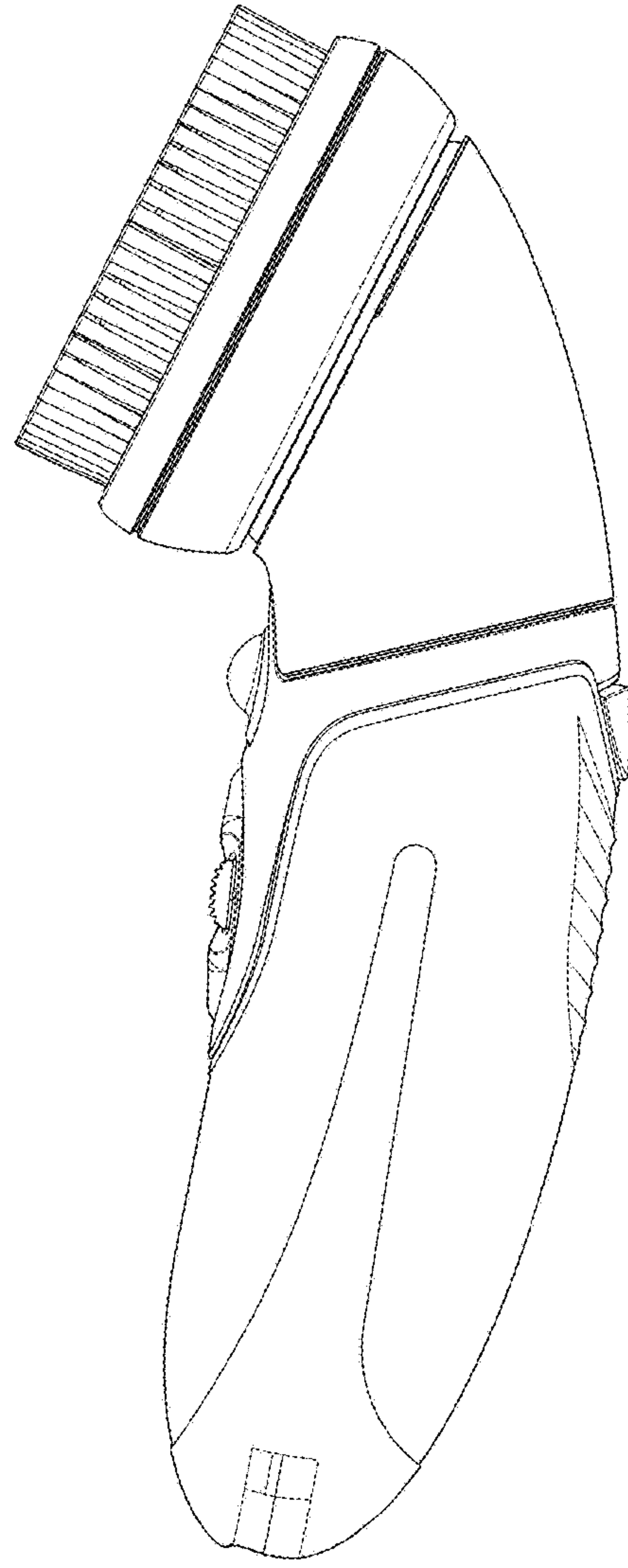

FIG. 5

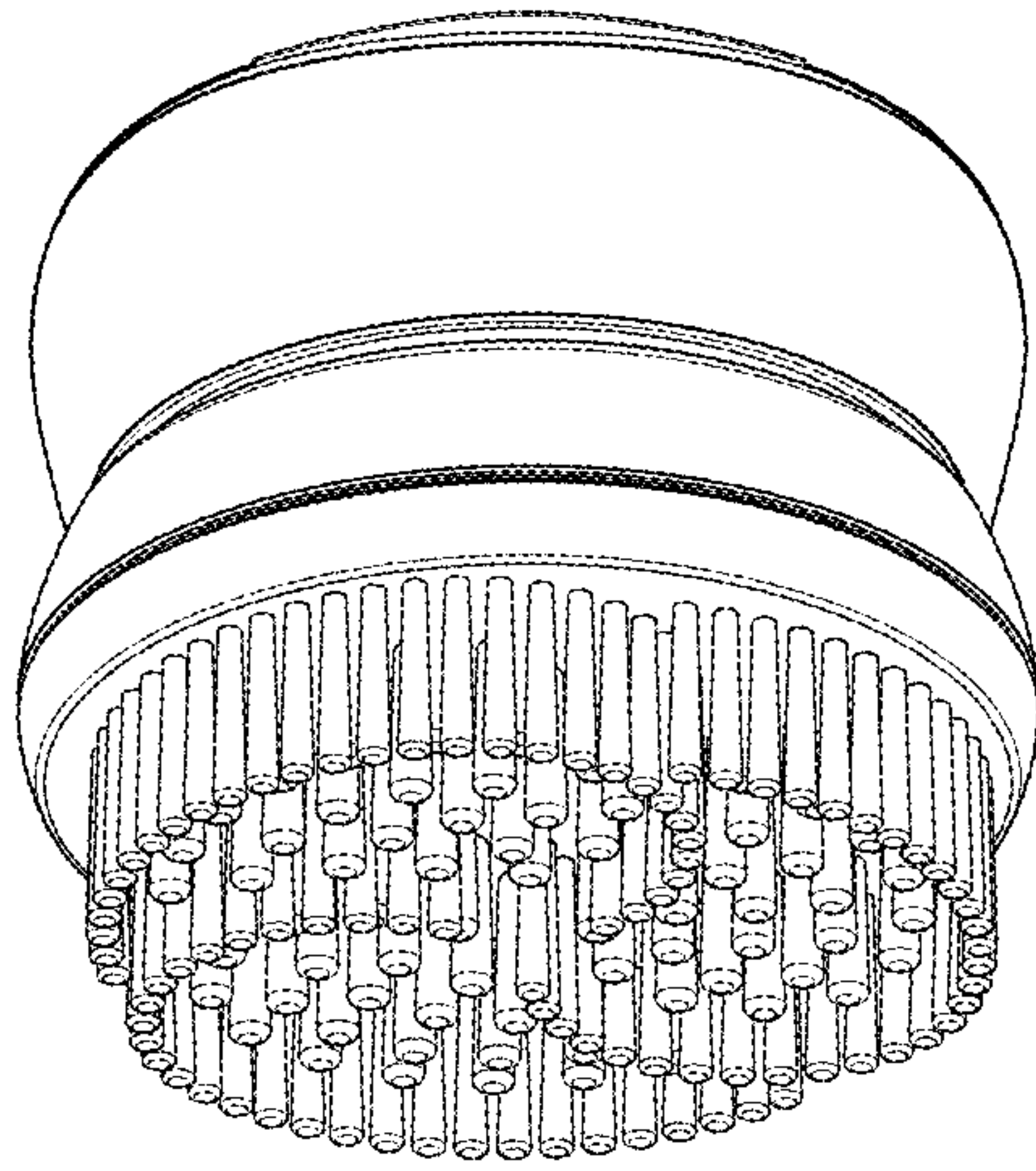

FIG. 6

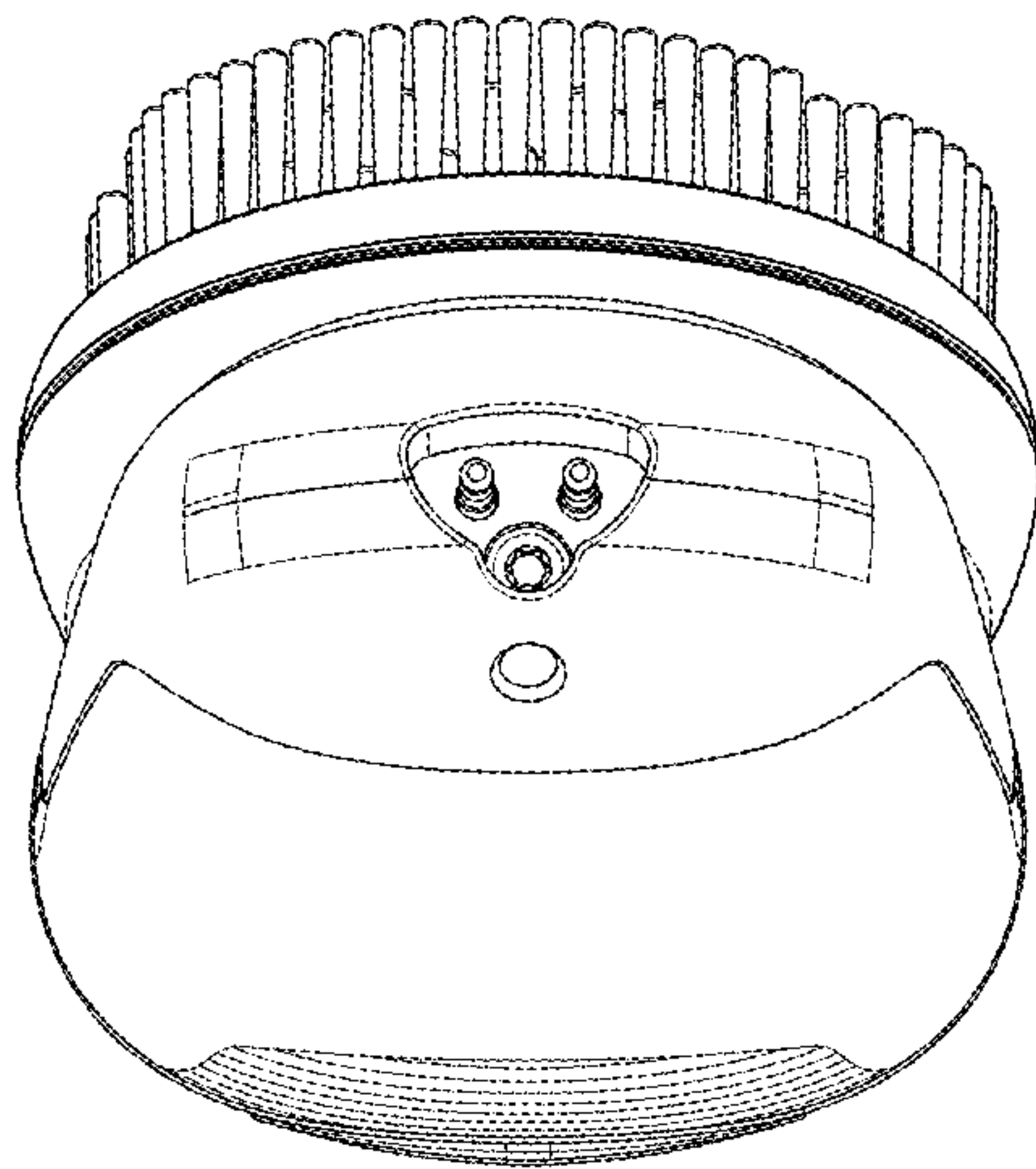

FIG. 7