



US00D804485S

(12) **United States Design Patent**
Yang et al.

(10) **Patent No.: US D804,485 S**

(45) **Date of Patent: ** Dec. 5, 2017**

(54) **MEMORY CARD SOCKET**

(71) Applicant: **Molex, LLC**, Lisle, IL (US)

(72) Inventors: **In Chull Yang**, Ansan (KR); **Da Woon Lee**, Ansan (KR)

(73) Assignee: **Molex, LLC**, Lisle, IL (US)

(**) Term: **15 Years**

(21) Appl. No.: **29/548,542**

(22) Filed: **Dec. 15, 2015**

(30) **Foreign Application Priority Data**

Nov. 4, 2015 (KR) 30-2015-0055558

(51) **LOC (10) Cl.** **14-02**

(52) **U.S. Cl.**
USPC **D14/435**; D14/436

(58) **Field of Classification Search**
USPC D14/435, 436; D13/146, 147, 133;
361/752-760, 732, 734, 737, 784, 796,
361/725, 727, 679.32, 801-803, 684;
439/629-633, 541.5, 188, 488, 489,
439/325-331, 266-275, 342, 587-589,
439/540.1, 569-573, 527, 607.33, 147,
439/160, 153, 159, 377, 379, 155, 156,
439/380, 946, 157, 260, 638, 55, 65, 64,
439/607.01, 607.02, 296, 108, 345, 928.1,
439/607.07, 607.13, 626, 923, 679.31,
439/679.32, 679.33, 679.38, 679.58,
439/679.59, 607.22, 607.29, 607.31;
200/51.09, 51.11

CPC G06K 13/0825; G06K 13/085; G06K
13/0856; G06K 13/0806; G06K 13/0862;
G06K 13/0831; G06K 13/08; G06K
13/0818; G06K 13/14; G06K 7/0021;
G06K 7/0073; G06K 7/0013; G06K
7/0026; G06K 7/003; G06K 7/0069;
G06K 7/0043; G06K 7/0078; G06K
7/0047; G06K 7/0052; G06K 7/0056;
G06K 7/00; G06K 7/006; G06K 7/0034;

G06K 19/07309; H05K 7/1409; H05K
7/14; H05K 7/1405; H05K 7/1408; H05K
7/1417; H05K 7/1418; H05K 7/142;
H05K 7/1427; H05K 7/1461; H05K
7/1474; H05K 7/1422; H05K 7/1424;
H05K 7/1452; H05K 7/1454; H05K
5/0269; H05K 5/0256; H05K 5/0295;
H05K 5/0217; G06F

(Continued)

(56) **References Cited**

U.S. PATENT DOCUMENTS

5,716,221 A * 2/1998 Kantner G06K 19/077
361/737
5,823,828 A * 10/1998 Bricaud G06K 7/0021
439/630

(Continued)

Primary Examiner — Susan Moon Lee

(74) *Attorney, Agent, or Firm* — James A. O'Malley

(57) **CLAIM**

The ornamental design for a memory card socket, as shown and described.

DESCRIPTION

FIG. 1 is a perspective view of a memory card socket showing our new design;

FIG. 2 is a top view of the memory card socket;

FIG. 3 is a bottom view of the memory card socket;

FIG. 4 is a left side view of the memory card socket;

FIG. 5 is a right side view of the memory card socket;

FIG. 6 is a rear view of the memory card socket;

FIG. 7 is a front view of the memory card socket; and,

FIG. 8 is an alternative perspective view of the memory card socket where a memory card is positioned within the memory card socket.

The memory card illustrated in FIG. 8 does not form a part of the claimed design, but rather is illustrated to show environment.

1 Claim, 6 Drawing Sheets

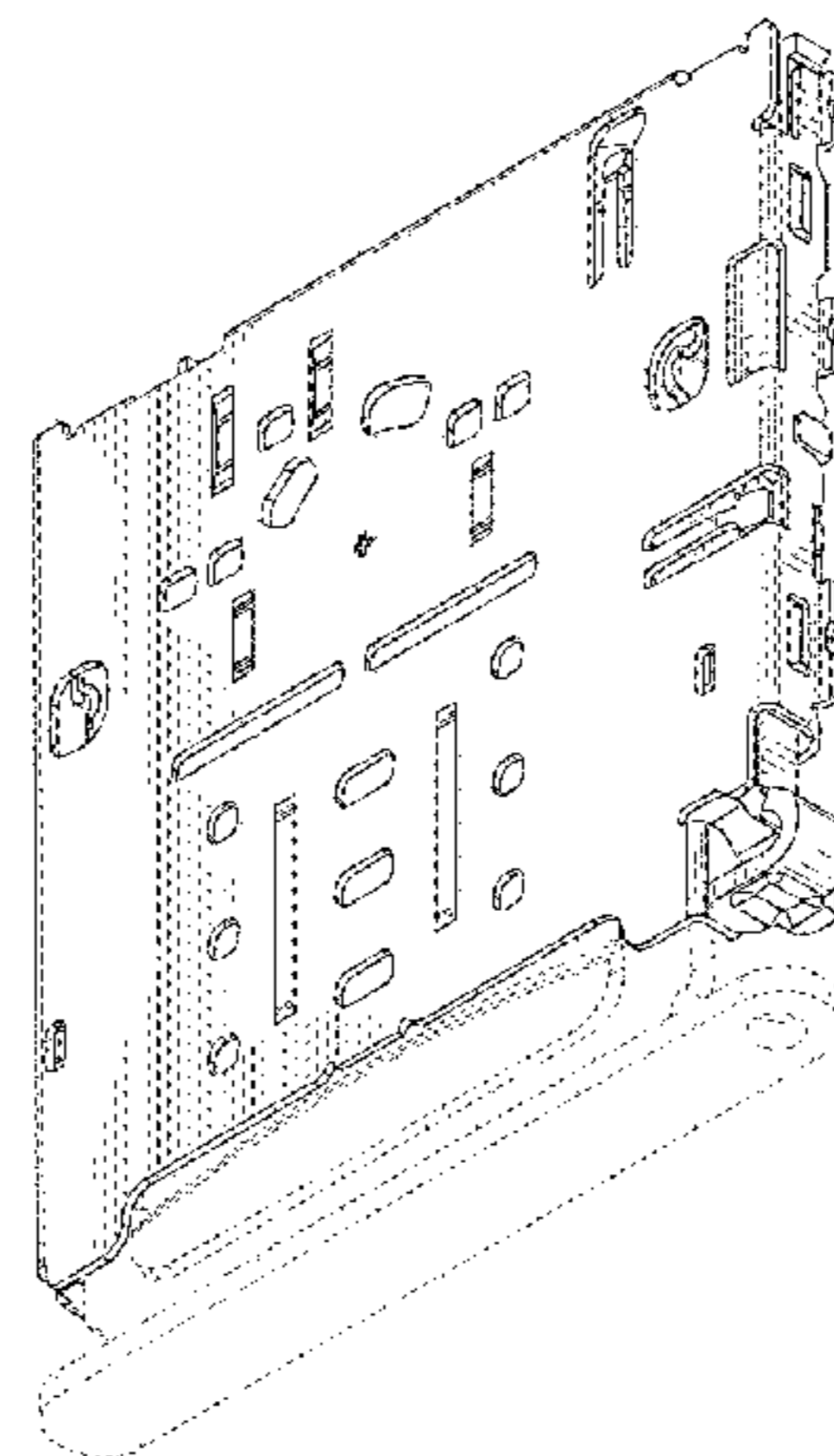
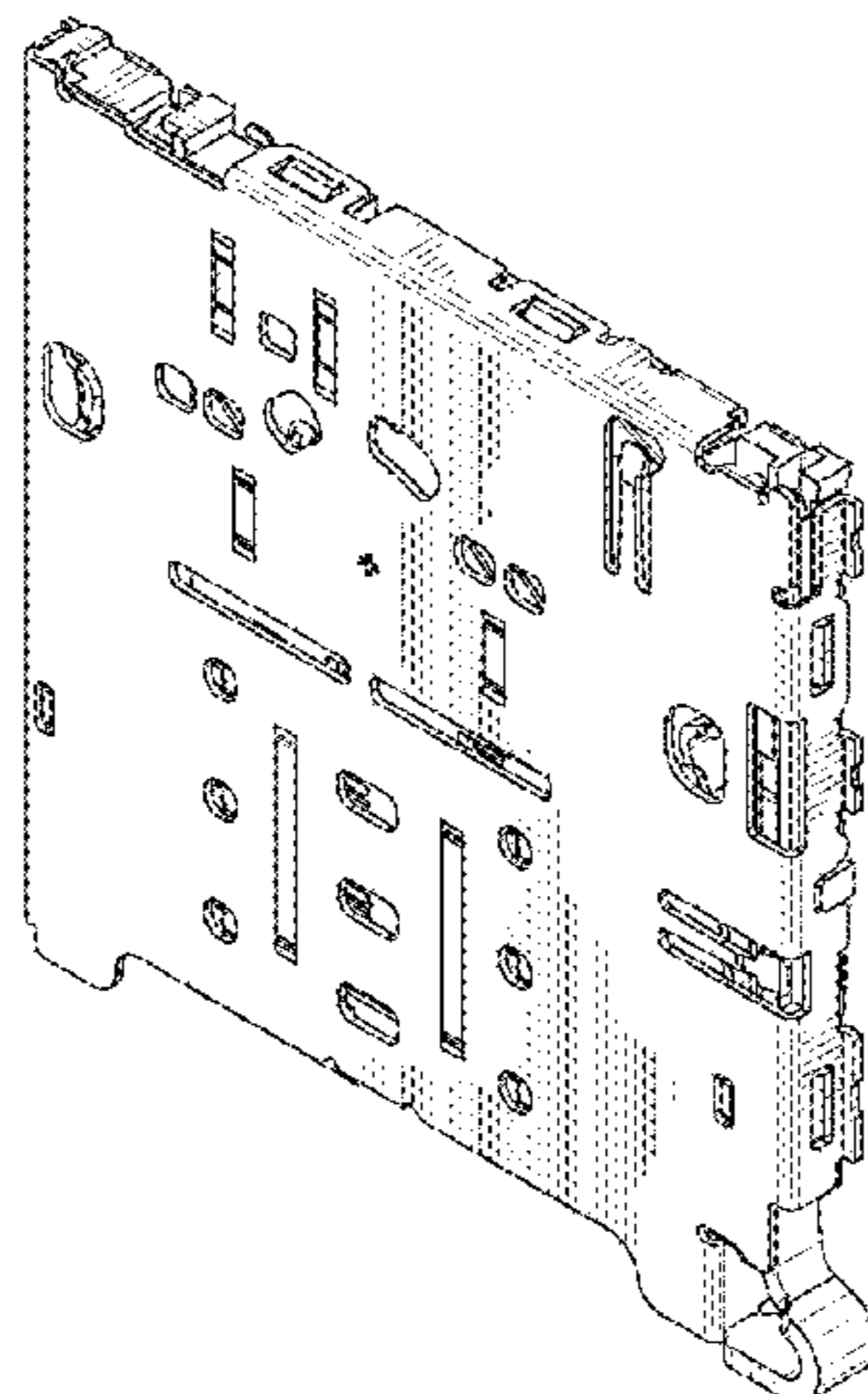

(58) **Field of Classification Search**

CPC 1/184; G06F 1/185; H01R 13/00; H01R 13/2442; H01R 13/701; H01R 13/64; H01R 13/70; H01R 13/46; H01R 13/703; H01R 13/24; H01R 13/6335; H01R 13/633; H01R 13/635; H01R 13/642; H01R 13/7031-13/7035; H01R 13/629; H01R 13/52; H01R 13/62988; H01R 13/62933; H01R 13/16683; H01R 13/6581; H01R 13/65802; H01R 13/5219; H01R 24/62; H01R 27/00; H01R 27/02; H01R 12/88; H01R 12/721; H01R 12/7094; H01R 12/55; H01R 12/57; H01R 12/89; H01R 12/716; H01R 12/714; H01R 23/7068; H04B 1/3816; H04B 1/3818; Y10S 439/923; H01H 9/0271; G06H 13/085; H04M 1/0202; H04M 1/026

See application file for complete search history.

(56) **References Cited**

U.S. PATENT DOCUMENTS

6,015,311 A * 1/2000 Benjamin G06K 7/0021
235/441
6,050,848 A * 4/2000 Yao H01R 31/06
439/483
6,095,868 A * 8/2000 Hyland G06K 7/0021
439/630
6,099,337 A * 8/2000 Chan G06K 7/0021
361/737
6,126,464 A * 10/2000 Chang H01R 12/7094
235/441
6,162,075 A * 12/2000 Hara H01R 13/633
439/159
6,219,256 B1 * 4/2001 Wu H05K 5/0265
361/759
6,234,810 B1 * 5/2001 Schnell G06K 7/0021
439/76.1
6,241,545 B1 * 6/2001 Bricaud G06K 7/0021
439/326
6,379,167 B1 * 4/2002 Zhang G06K 13/08
439/157
6,402,529 B2 * 6/2002 Saito G06K 7/0021
361/737
6,609,936 B2 * 8/2003 Bricaud H01R 13/635
439/108
6,652,299 B2 * 11/2003 Sato G06K 13/08
439/152
6,840,807 B2 * 1/2005 Ooya H01R 23/6873
439/607.01
6,976,880 B1 * 12/2005 Chi-te G06K 7/0069
439/159
7,018,234 B2 * 3/2006 Tanigawa H01R 29/00
439/541.5
7,052,316 B2 * 5/2006 Tanigawa G06K 13/0825
439/159
D523,860 S * 6/2006 Xu D14/436
7,081,020 B1 * 7/2006 Lee G06K 13/08
439/630
7,112,095 B2 * 9/2006 Shen G06K 7/0013
439/138
7,118,420 B1 * 10/2006 Lai H01R 13/64
439/630
7,137,836 B2 * 11/2006 Lu H01R 13/7035
439/188
D535,258 S * 1/2007 Sasaki D13/147
7,160,129 B2 * 1/2007 Yin H01R 12/89
439/326
7,175,452 B1 * 2/2007 Lin H01R 13/629
439/159

7,220,138 B2 * 5/2007 Miyamoto G06K 13/0806
439/159
D546,288 S * 7/2007 Hsu D13/147
7,261,577 B1 * 8/2007 Lai G06K 7/0021
439/159
D559,188 S * 1/2008 Chiang D13/147
D559,787 S * 1/2008 Sasaki D13/147
7,329,134 B2 * 2/2008 Hsu G06K 13/08
439/159
7,341,466 B1 * 3/2008 Kondo H01R 13/641
439/159
D566,655 S * 4/2008 Chen D13/147
7,351,109 B2 * 4/2008 Wang H01R 13/2442
439/631
7,361,037 B2 * 4/2008 Kanazawa H01R 13/6335
439/159
7,364,820 B2 * 4/2008 Tanaka G06K 13/08
439/630
D568,250 S * 5/2008 Wu D13/147
D569,346 S * 5/2008 Wu D13/147
7,367,827 B2 * 5/2008 Chen G06K 13/08
439/159
7,371,079 B2 * 5/2008 Yang G06K 7/0021
439/630
7,381,069 B2 * 6/2008 Saito H01R 13/6335
439/159
D576,954 S * 9/2008 Hsiao D13/147
7,427,206 B2 * 9/2008 Takei G06K 13/0831
439/159
7,435,115 B2 * 10/2008 Kiryu H01R 13/631
439/159
7,448,890 B2 * 11/2008 Ting G06K 13/0806
439/159
7,467,959 B2 * 12/2008 Matsukawa G06K 7/0047
439/159
7,481,686 B2 * 1/2009 Uchida G06K 7/0021
439/630
7,507,098 B1 * 3/2009 Hung H01R 13/633
439/159
7,517,251 B2 * 4/2009 Richter G06K 7/0013
439/620.04
7,540,783 B2 * 6/2009 Lai G06K 7/0021
439/630
7,578,703 B2 * 8/2009 Hsiao G06K 7/0021
439/159
7,632,117 B1 * 12/2009 Van der Steen G06K 13/08
439/159
7,635,276 B1 * 12/2009 Chu H01R 13/2442
439/326
7,637,759 B2 * 12/2009 Kobayashi G06K 13/08
439/153
7,645,166 B1 * 1/2010 Wang H01R 13/641
439/488
7,699,661 B2 * 4/2010 Wu G06K 13/0862
439/630
7,717,724 B2 * 5/2010 Yu G06K 13/08
439/159
7,766,678 B1 * 8/2010 Abe H05K 5/0295
439/159
7,794,249 B2 * 9/2010 Yu H01R 13/633
439/159
7,833,063 B2 * 11/2010 Matsumoto G06K 7/0021
439/630
7,866,988 B2 * 1/2011 Shimada G06K 7/0021
439/76.1
7,866,998 B2 * 1/2011 Chen G06K 7/0047
439/159
7,867,034 B1 * 1/2011 Sato G06K 7/0043
439/159
D632,695 S * 2/2011 Berntsen D14/435
7,955,135 B2 * 6/2011 Wang H01R 12/57
439/630
7,967,640 B2 * 6/2011 Hashimoto H01R 13/2464
439/630
8,033,865 B2 * 10/2011 Li H01R 12/714
439/633

(56)		References Cited			
U.S. PATENT DOCUMENTS					
8,147,262	B1 *	4/2012	Su	G06K 13/0825	2003/0211783 A1 * 11/2003 Matsunaga H01R 12/7076
				439/159	439/630
8,197,272	B2 *	6/2012	Matsunaga	G06K 13/08	2004/0014342 A1 * 1/2004 Yu G06K 13/0856
				439/160	439/159
8,259,465	B2 *	9/2012	Zhou	G06K 13/08	2004/0023538 A1 * 2/2004 Masson G06K 7/0069
				361/737	439/188
8,292,642	B1 *	10/2012	Lee	G06K 7/0026	2004/0029446 A1 * 2/2004 Ooya G06K 13/08
				439/159	439/630
8,292,646	B2 *	10/2012	Hsu	G06K 13/0862	2004/0106315 A1 * 6/2004 Murayama G06K 13/0825
				439/325	439/188
8,292,667	B1 *	10/2012	Huang	H01R 12/714	2004/0132326 A1 * 7/2004 Matsunaga G06K 13/0806
				439/541.5	439/159
8,371,865	B1 *	2/2013	Su	G06K 13/0862	2004/0209506 A1 * 10/2004 Kawahata G06K 7/0069
				439/155	439/188
8,371,866	B1 *	2/2013	Su	G06K 13/0862	2004/0266237 A1 * 12/2004 Kodera G06K 13/08
				439/159	439/159
8,376,764	B1 *	2/2013	Su	G06K 13/0831	2005/0059281 A1 * 3/2005 Bricaud G06K 7/0021
				439/157	439/188
8,393,909	B1 *	3/2013	Lai	G06K 13/0831	2005/0142914 A1 * 6/2005 Kodera H01R 13/633
				439/159	439/159
8,414,316	B2 *	4/2013	Zhang	G06K 7/003	2006/0040560 A1 * 2/2006 Uchida H01R 13/24
				439/159	439/630
8,419,454	B1 *	4/2013	Ji	G06K 7/0021	2006/0105633 A1 * 5/2006 Richter G06K 7/0013
				439/159	439/630
8,469,747	B2 *	6/2013	Huang	H01R 25/006	2006/0121941 A1 * 6/2006 Shiflett G06K 7/0021
				439/629	455/558
8,496,490	B2 *	7/2013	Takai	G06K 7/0052	2006/0124739 A1 * 6/2006 Kojima G06K 19/077
				439/159	235/441
8,500,469	B2 *	8/2013	Takai	G06K 7/0043	2006/0196781 A1 * 9/2006 Kimura G06F 1/187
				439/159	206/39
8,517,745	B1 *	8/2013	Yang	H01R 12/721	2007/0037424 A1 * 2/2007 Matsukawa G06K 13/08
				439/152	439/159
8,517,770	B1 *	8/2013	Chan	G06K 7/0043	2007/0093137 A1 * 4/2007 Zhao G06K 13/085
				439/159	439/630
8,597,057	B2 *	12/2013	Yu	H01R 13/635	2007/0178733 A1 * 8/2007 Sadatoku H01R 12/7005
				439/159	439/159
8,651,884	B1 *	2/2014	Rivera	H01R 13/635	2008/0102680 A1 * 5/2008 Chang G06K 7/0069
				439/159	439/326
D704,141	S *	5/2014	Tsuji	D13/147	2008/0274648 A1 * 11/2008 Takahashi G06K 7/0021
				D13/147	439/630
D704,142	S *	5/2014	Kim	D13/147	2008/0298006 A1 * 12/2008 Kim G06K 7/0021
				D13/133	361/679.32
D710,803	S *	8/2014	Yun	D13/133	2008/0299829 A1 * 12/2008 Kim G06K 7/0021
				D13/133	439/630
D711,321	S *	8/2014	Yun	D13/133	2009/0035971 A1 * 2/2009 Tsuji G06K 7/0021
				G06K 13/0825	439/159
8,811,025	B2 *	8/2014	Kume	G06K 13/0825	2009/0149058 A1 * 6/2009 Ting G06K 7/0021
				361/754	439/377
8,821,191	B2 *	9/2014	Soo	H01R 12/55	2009/0221168 A1 * 9/2009 Yu G06K 7/0021
				439/630	439/159
8,827,749	B2 *	9/2014	Kim	G06K 7/0043	2009/0267677 A1 * 10/2009 Myers G06K 13/08
				439/607.08	327/356
8,858,247	B2 *	10/2014	Zhu	G06K 7/0056	2009/0275221 A1 * 11/2009 Murayama G06K 7/0021
				439/159	439/74
8,888,534	B2 *	11/2014	Toda	H01R 12/7023	2009/0275237 A1 * 11/2009 Chiang H01R 13/2442
				439/630	439/629
D726,656	S *	4/2015	Shimada	D13/147	2009/0305567 A1 * 12/2009 Lin G06K 13/08
				D13/147	439/629
D729,170	S *	5/2015	Kim	D13/147	2010/0035474 A1 * 2/2010 Xu G06K 7/0021
				D13/147	439/630
D741,810	S *	10/2015	Sasaki	D13/147	2010/0055985 A1 * 3/2010 Hu H01R 13/2442
				D13/147	439/626
D742,832	S *	11/2015	Mikawa	D13/147	2010/0062620 A1 * 3/2010 Lei H01R 13/2442
				H01R 12/72	439/66
9,178,325	B2 *	11/2015	Soo	H01R 12/72	2010/0087074 A1 * 4/2010 Yu G06K 7/0021
				H01R 13/193	439/81
9,318,830	B2 *	4/2016	Choi	H01R 13/193	2010/0112839 A1 * 5/2010 Sun H01R 12/7094
				G06K 13/0812	439/152
9,396,416	B2 *	7/2016	Matsumoto	G06K 13/0812	2010/0144179 A1 * 6/2010 Guo G06K 7/0073
				H05K 7/1409	439/159
9,491,883	B2 *	11/2016	Takasaki	H05K 7/1409	2010/0267260 A1 * 10/2010 Yu G06K 13/08
				G06K 7/003	439/159
9,531,101	B2 *	12/2016	Mikawa	G06K 7/003	2011/0034050 A1 * 2/2011 Zhu G06K 13/08
				H01R 13/633	439/159
9,608,372	B2 *	3/2017	Hu	H01R 13/633	2011/0039442 A1 * 2/2011 Kim G06K 7/0021
				H01R 13/70	439/377
9,608,384	B2 *	3/2017	Soo	H01R 13/70	
				H01R 13/642	
9,627,813	B1 *	4/2017	Wu	H01R 13/642	
				G06K 7/0047	
2001/0031571	A1 *	10/2001	Ito	G06K 7/0047	
				439/159	
2002/0052147	A1 *	5/2002	Sato	G06K 13/0862	
				439/630	
2002/0146923	A1 *	10/2002	Yu	G06K 13/08	
				439/157	
2003/0109178	A1 *	6/2003	Ohashi	G06K 7/0021	
				439/630	

(56)

References Cited

U.S. PATENT DOCUMENTS

2016/0013571	A1*	1/2016	Ning	H01R 12/718	439/630
2016/0036143	A1*	2/2016	Motohashi	G06K 13/08	439/160
2016/0036146	A1*	2/2016	Wang	H01R 13/2478	439/630
2016/0086000	A1*	3/2016	Sarraf	G06K 7/0056	439/529
2016/0093965	A1*	3/2016	Fang	H01R 12/714	439/81
2016/0111801	A1*	4/2016	Zeng	H01R 12/7076	439/660
2016/0111802	A1*	4/2016	Shimotsu	H01R 12/7076	439/159
2016/0118733	A1*	4/2016	Tanaka	G06K 7/04	439/629
2016/0149330	A1*	5/2016	Kusuhara	H01R 13/2442	439/629
2016/0164225	A1*	6/2016	Nagase	H04B 1/3816	439/159
2016/0164226	A1*	6/2016	Hirata	H04B 1/3816	439/155
2016/0248184	A1*	8/2016	Motohashi	G06K 7/00	
2016/0254606	A1*	9/2016	Hu	G06K 13/08	439/632
2016/0292118	A1*	10/2016	Zhu	G06F 13/4068	
2016/0359247	A1*	12/2016	Hirata	H01R 12/714	
2016/0359267	A1*	12/2016	Hu	G06K 7/0043	
2016/0359268	A1*	12/2016	Hu	G06K 7/0043	
2016/0359269	A1*	12/2016	Motohashi	G06K 7/00	
2017/0012376	A1*	1/2017	Nakase	G06K 13/08	
2017/0040742	A1*	2/2017	Hu	H01R 13/635	
2017/0047958	A1*	2/2017	Wang	H01R 13/713	
2017/0054462	A1*	2/2017	Wang	G06F 13/4081	
2017/0070002	A1*	3/2017	Do	H01R 13/635	
2017/0093072	A1*	3/2017	Wang	H01R 13/26	
2017/0125932	A1*	5/2017	Wei	H01R 13/514	
2017/0162962	A1*	6/2017	Tan	H01R 12/57	

* cited by examiner

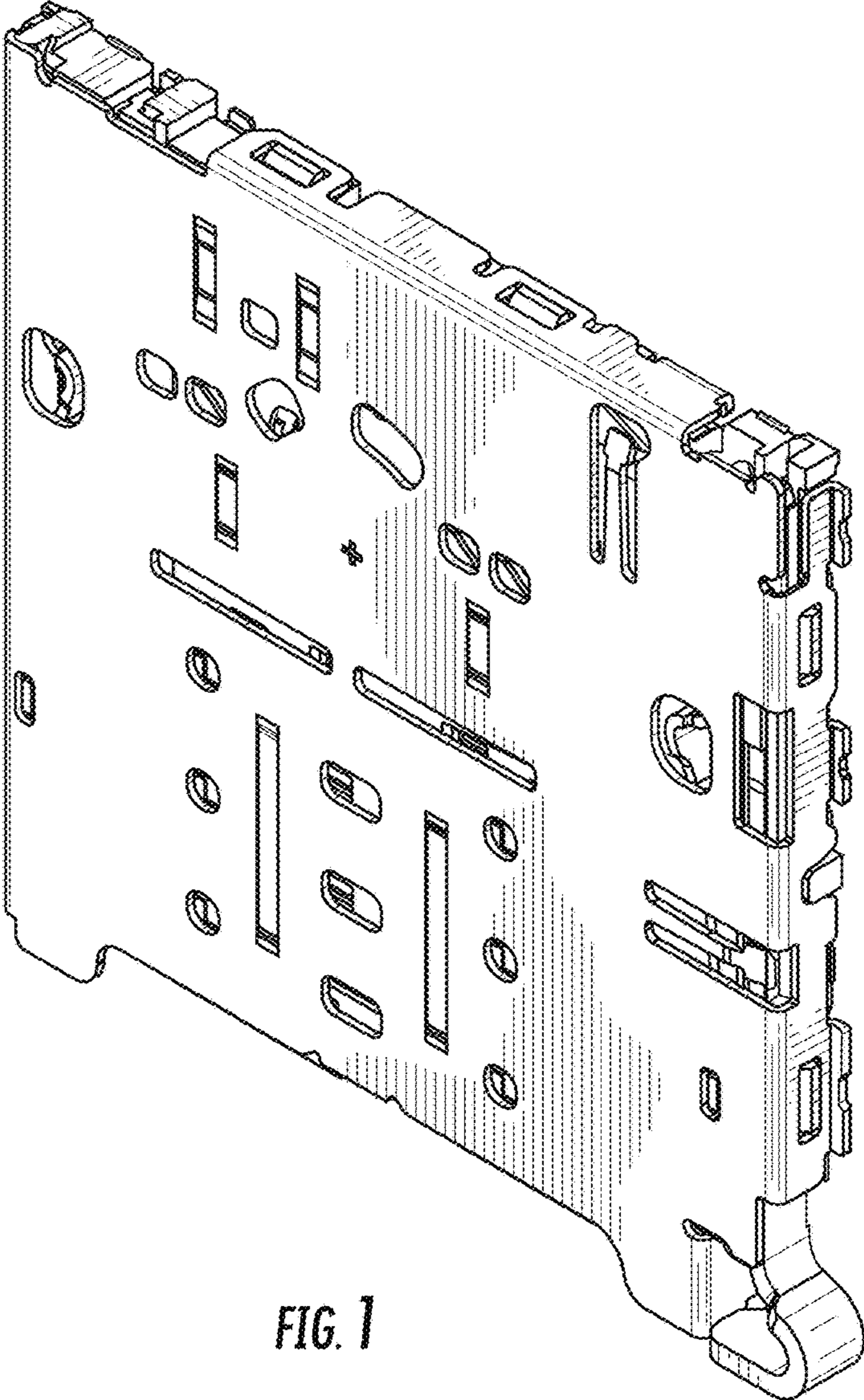

FIG. 1

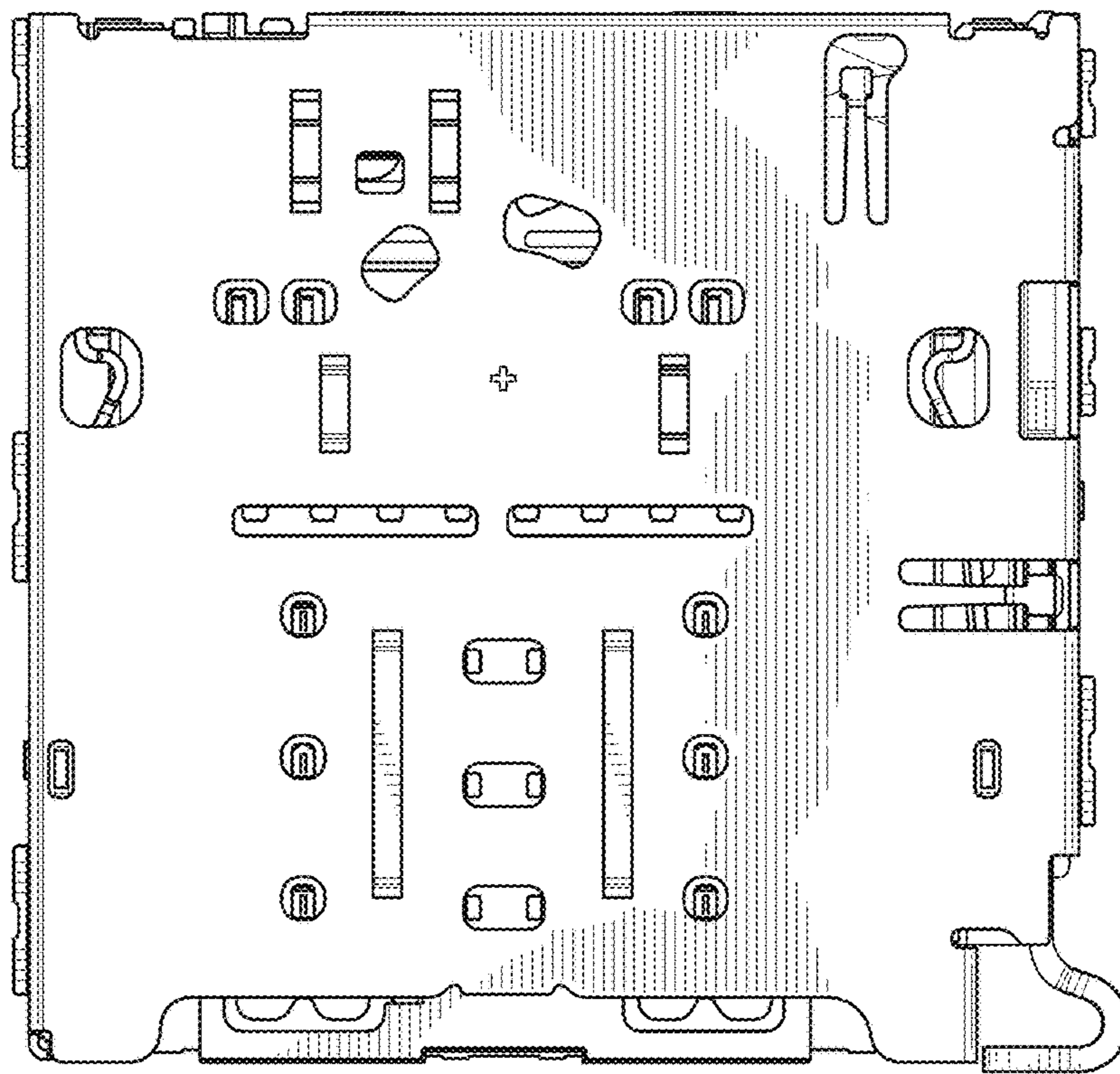

FIG. 2

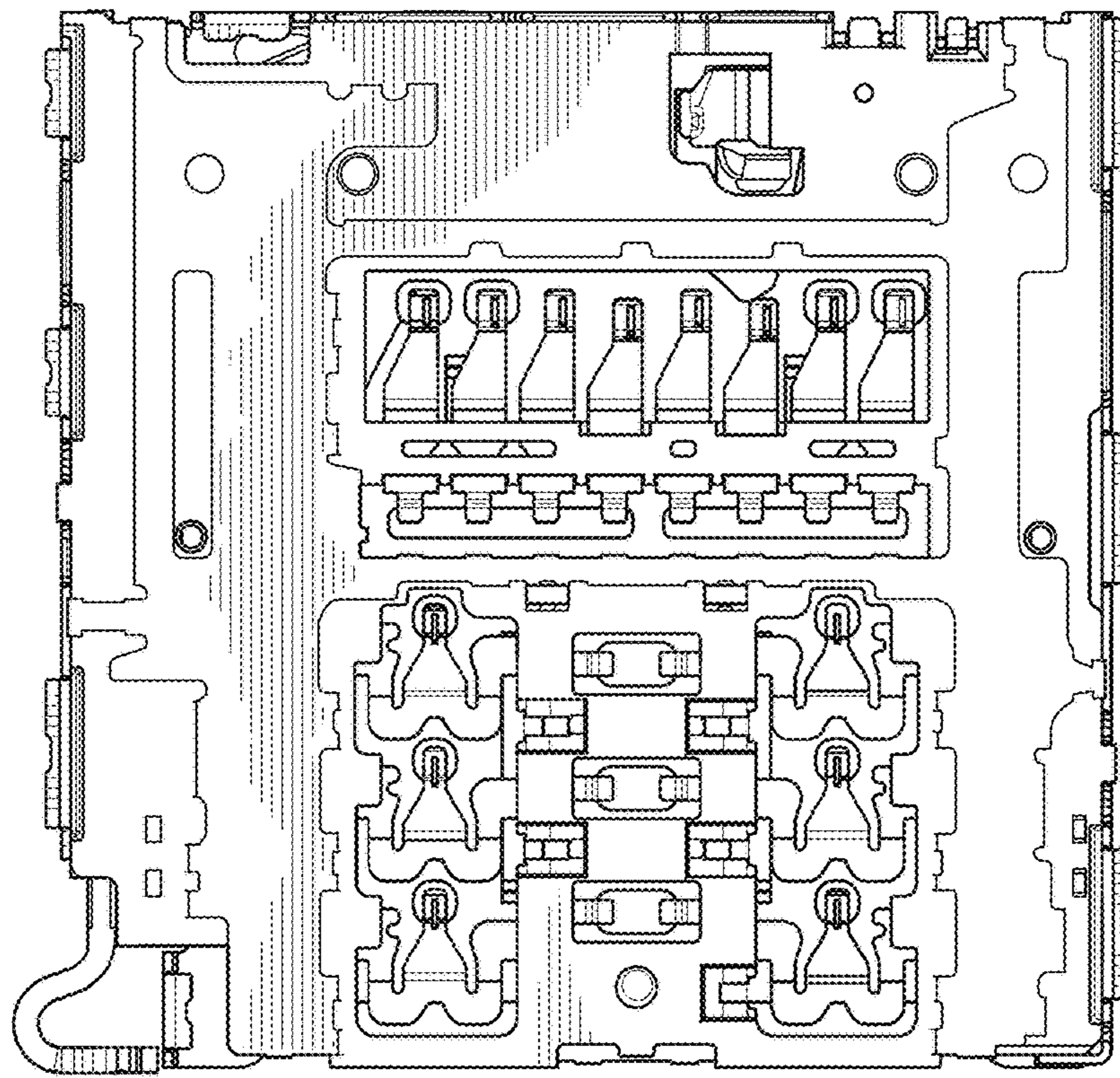

FIG. 3

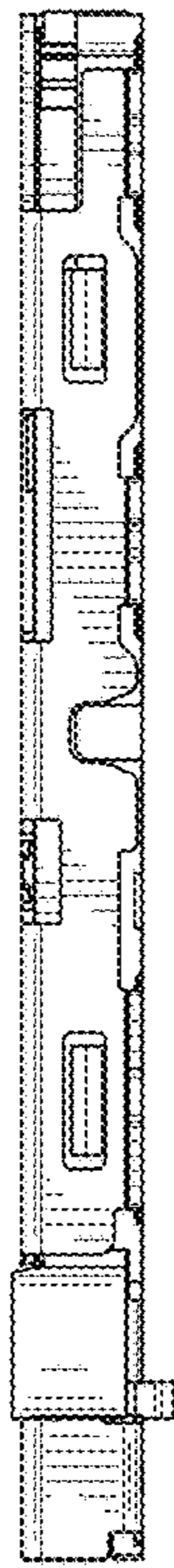

FIG. 4



FIG. 5

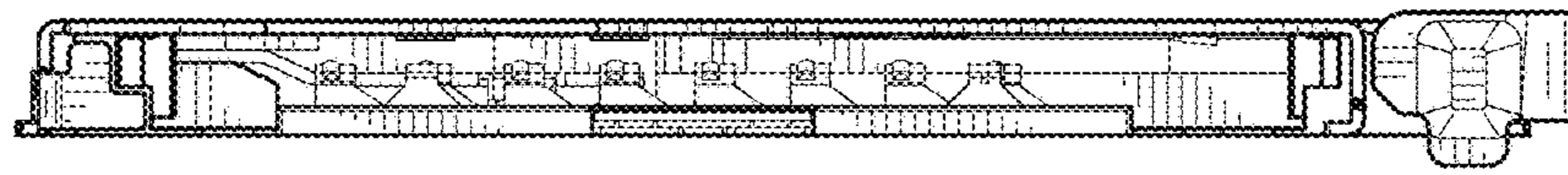

FIG. 6

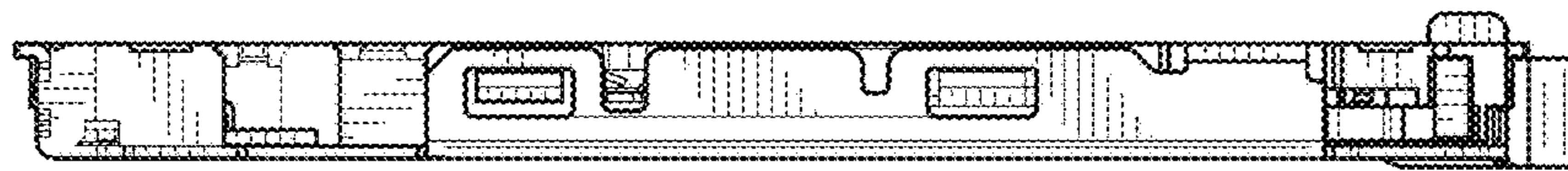

FIG. 7

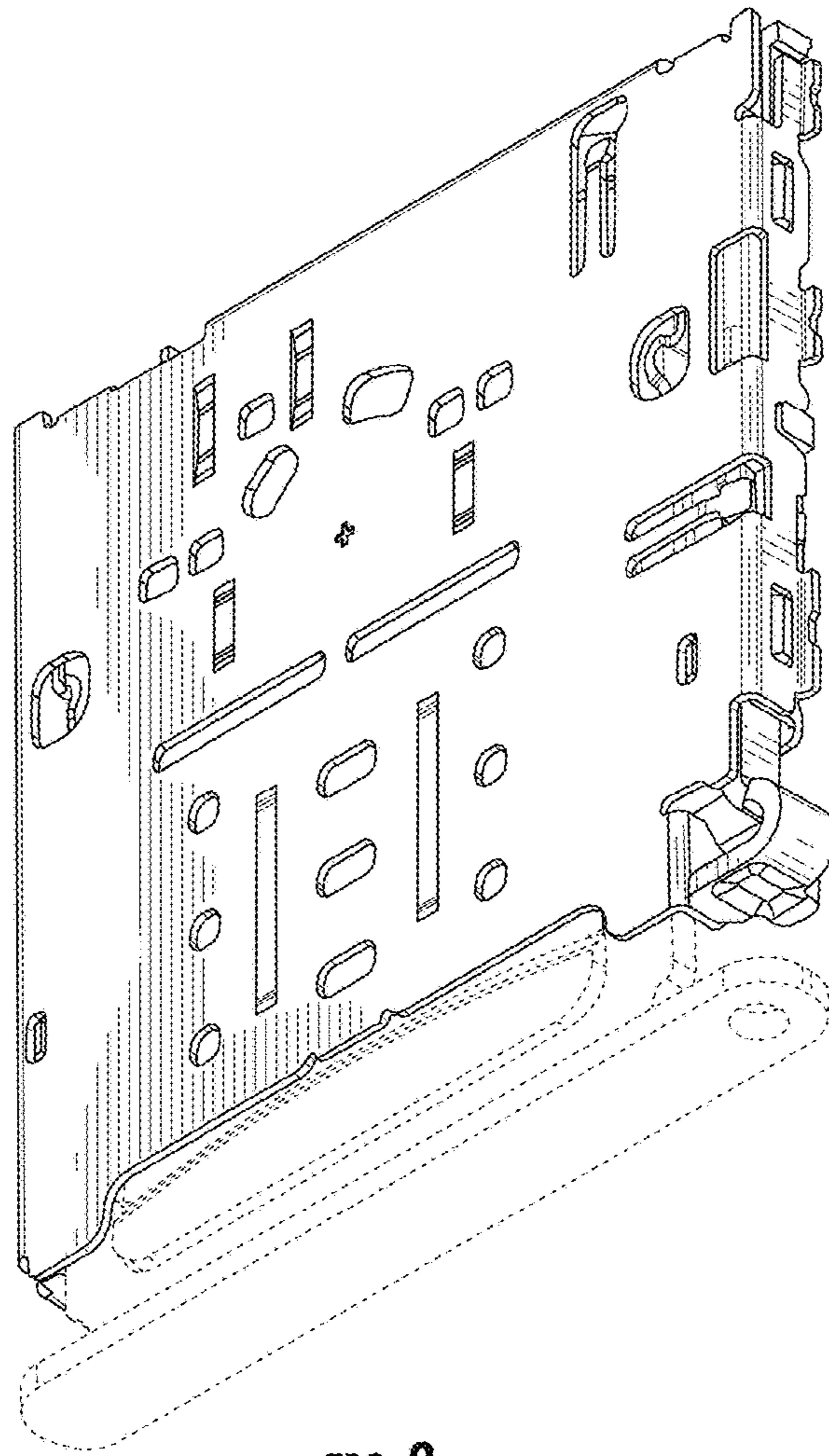

FIG. 8