



US00D804422S

(12) **United States Design Patent**  
**Sasaki et al.**

(10) **Patent No.:** **US D804,422 S**  
(45) **Date of Patent:** **\*\* Dec. 5, 2017**

(54) **ELECTRICAL CONNECTOR**

(71) Applicant: **Tyco Electronics Japan G.K.**,  
Kanagawa (JP)

(72) Inventors: **Yohichi Sasaki**, Kanagawa (JP);  
**Makiya Kimura**, Kanagawa (JP)

(73) Assignee: **Tyco Electronics Japan G.K.**,  
Kanagawa-ken (JP)

(\*\*) Term: **15 Years**

(21) Appl. No.: **29/540,792**

(22) Filed: **Sep. 28, 2015**

(30) **Foreign Application Priority Data**

Apr. 28, 2015 (JP) ..... 2015-009508

(51) **LOC (10) Cl.** ..... **13-03**

(52) **U.S. Cl.**  
USPC ..... **D13/147**

(58) **Field of Classification Search**

USPC ..... D13/120, 133, 146, 147, 154, 184, 199  
CPC ..... H01R 12/714; H01R 12/88; H01R 12/89;  
H01R 13/29; H01R 13/40; H01R 13/187;  
H01R 13/193; H01R 13/502; H01R  
13/627; H01R 13/62955; H01R 13/62994;  
H01R 13/639; H01R 13/6581; H01R  
13/6585; H01R 13/6588

See application file for complete search history.

(56) **References Cited**

**U.S. PATENT DOCUMENTS**

D704,654 S \* 5/2014 Smith ..... D13/147  
D713,799 S \* 9/2014 Buck ..... D13/147

9,680,267 B2 \* 6/2017 Hashiguchi ..... H01R 24/84  
2014/0127922 A1 \* 5/2014 Sasaki ..... H01R 13/187  
439/259  
2016/0322746 A1 \* 11/2016 Sasaki ..... H01R 13/62955  
2016/0344121 A1 \* 11/2016 Komoto ..... H01R 12/712

**FOREIGN PATENT DOCUMENTS**

JP 1460743 S 2/2013

\* cited by examiner

*Primary Examiner* — Daniel Bui

(74) *Attorney, Agent, or Firm* — Barley Snyder

(57) **CLAIM**

The ornamental design for an electrical connector, as shown and described.

**DESCRIPTION**

FIG. 1 is a front elevation view of an electrical connector, showing our new design;  
FIG. 2 is a top plan view thereof;  
FIG. 3 is a rear elevation view thereof;  
FIG. 4 is a bottom plan view thereof;  
FIG. 5 is a right side elevation view thereof;  
FIG. 6 is a left side elevation view thereof;  
FIG. 7 is a front, top and right perspective view thereof;  
FIG. 8 is a front, bottom and left perspective view thereof  
FIG. 9 is a rear, top and left perspective view thereof; and,  
FIG. 10 is a rear, bottom and right perspective view.

**1 Claim, 10 Drawing Sheets**

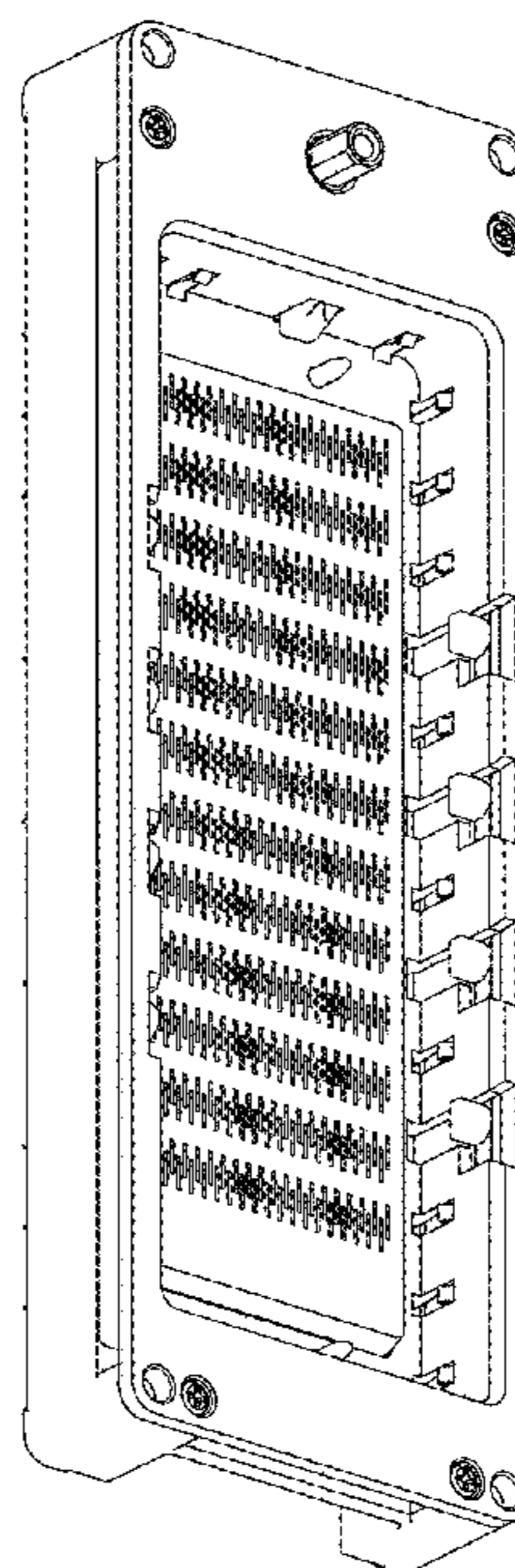
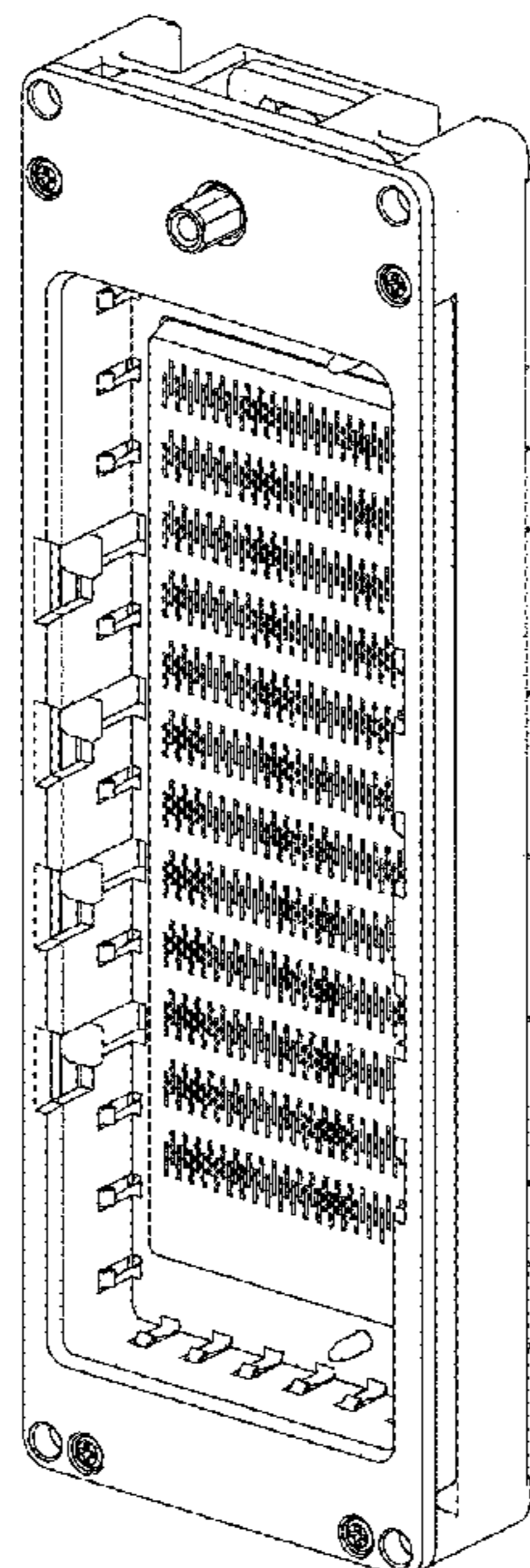

Fig. 1

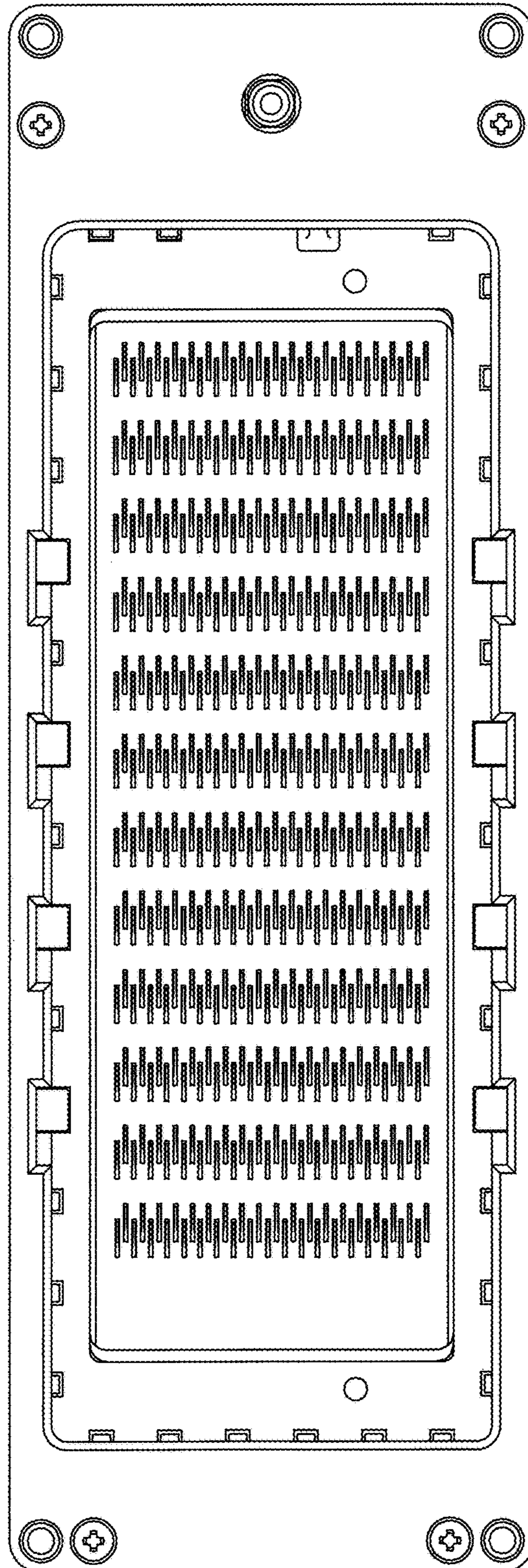

Fig. 2

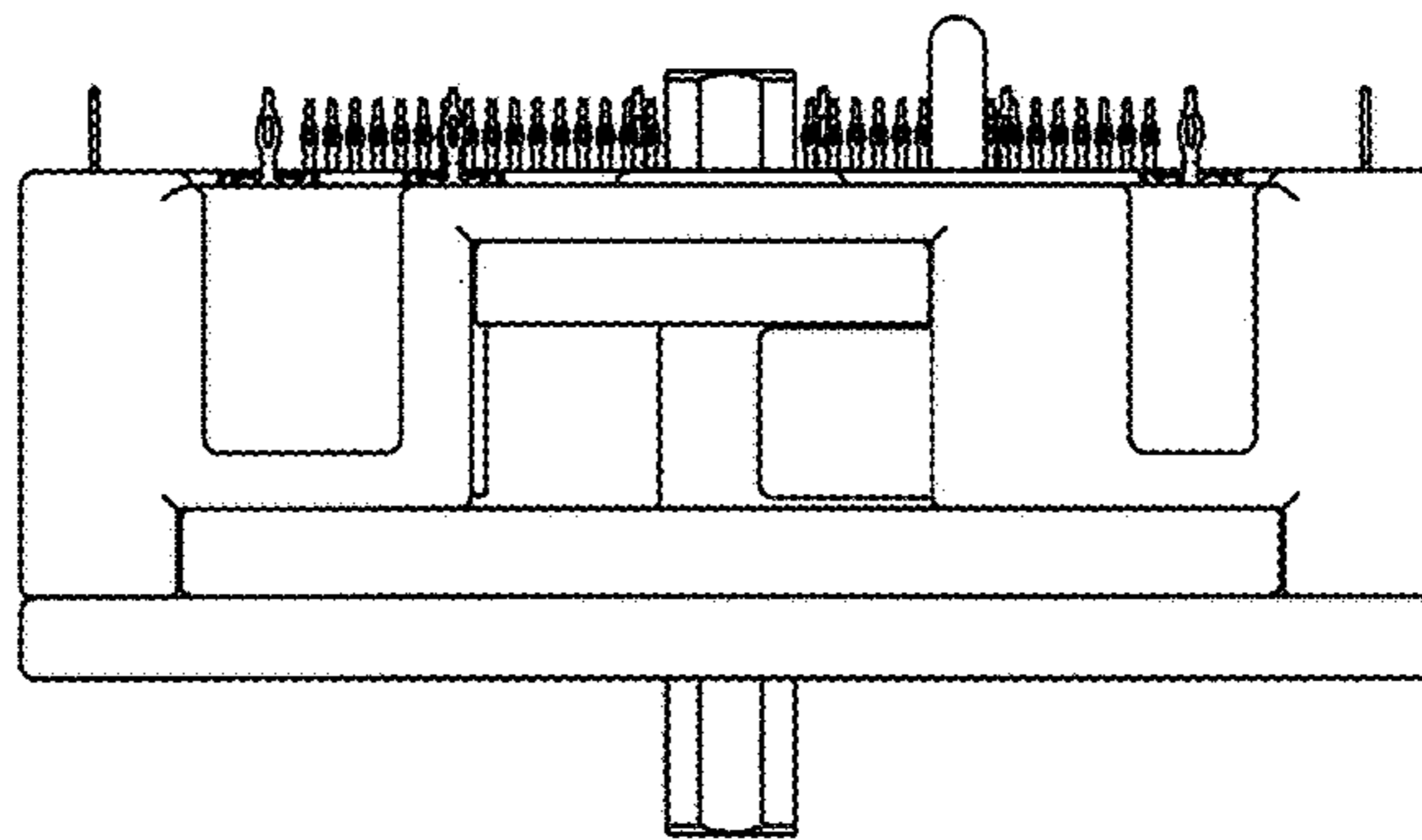



Fig. 3

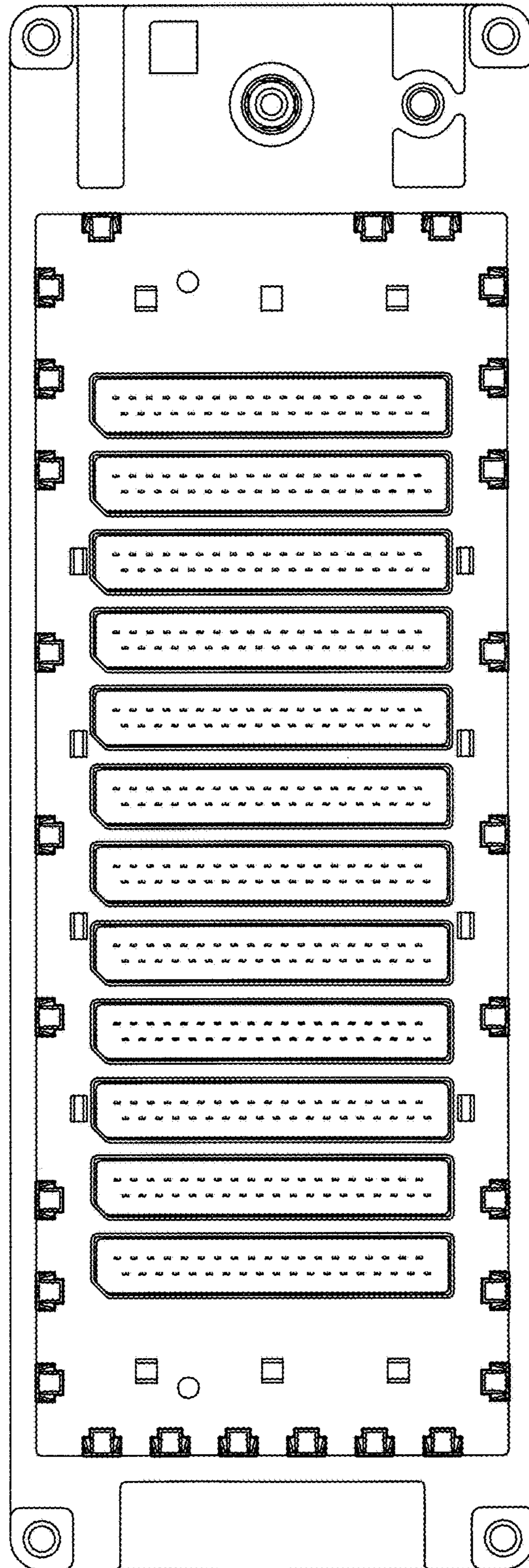

Fig. 4

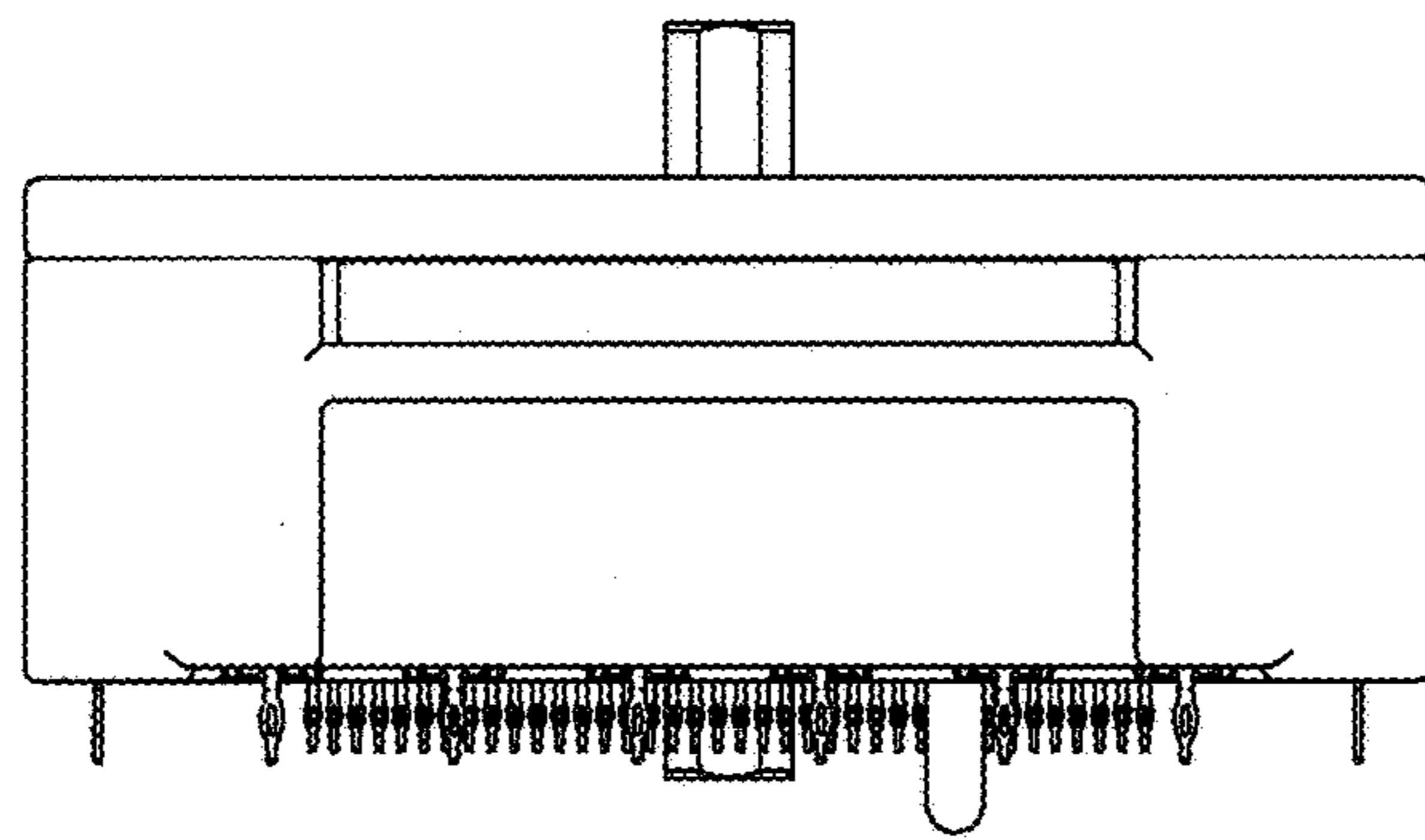

Fig. 5

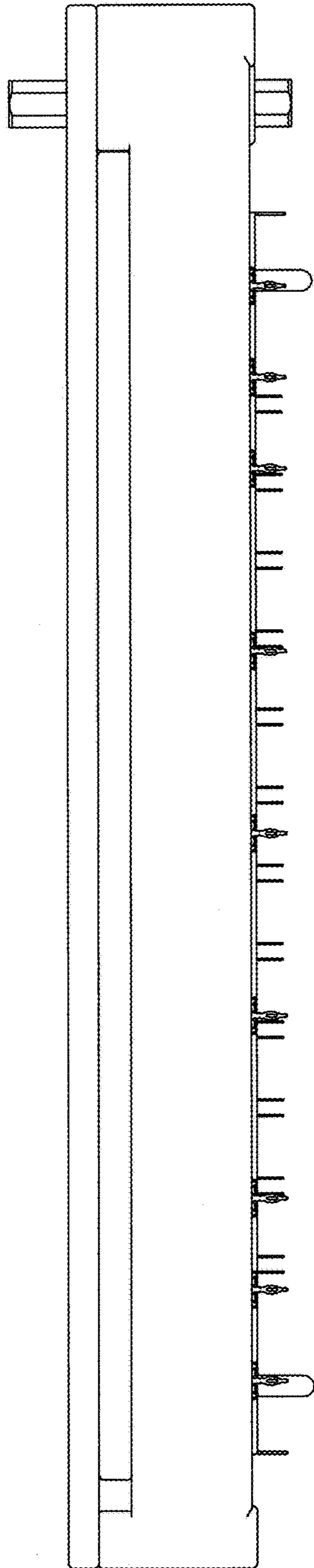

Fig. 6

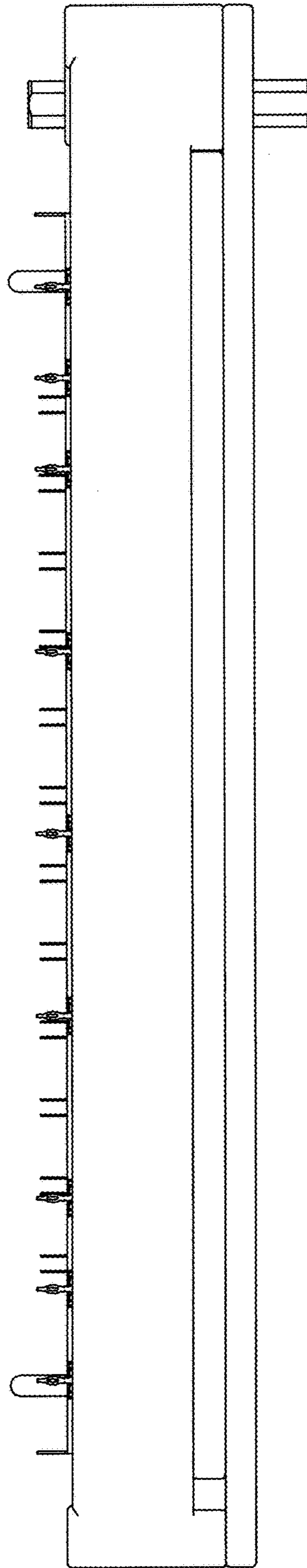

Fig. 7

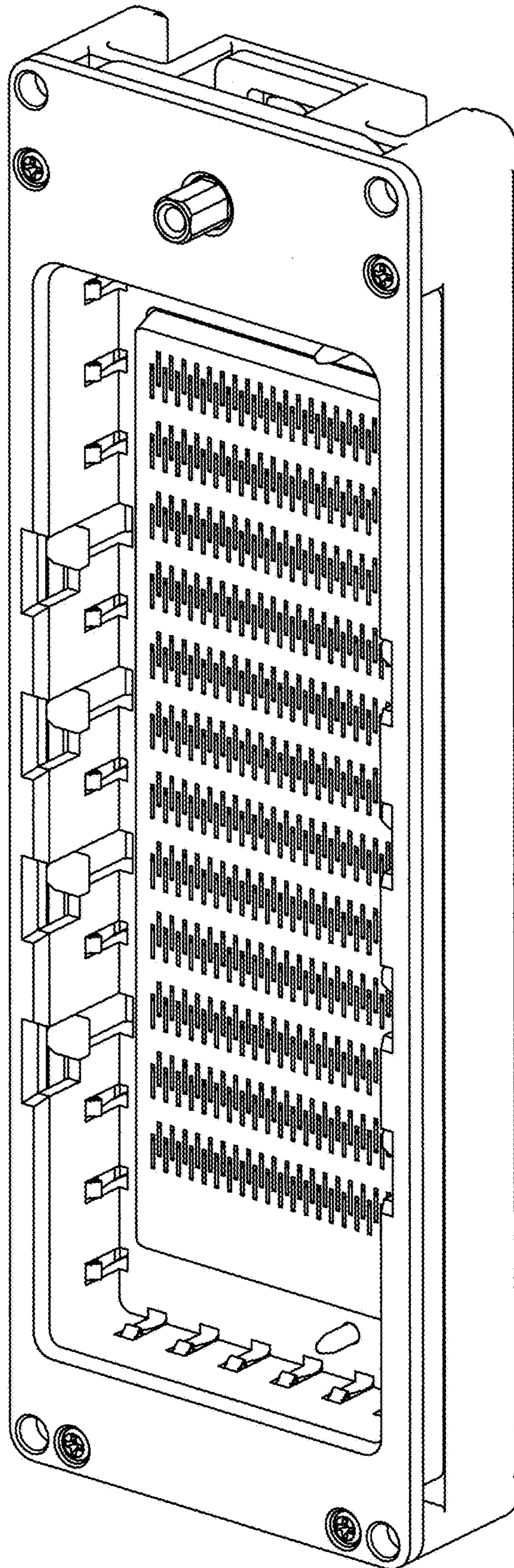



Fig. 8

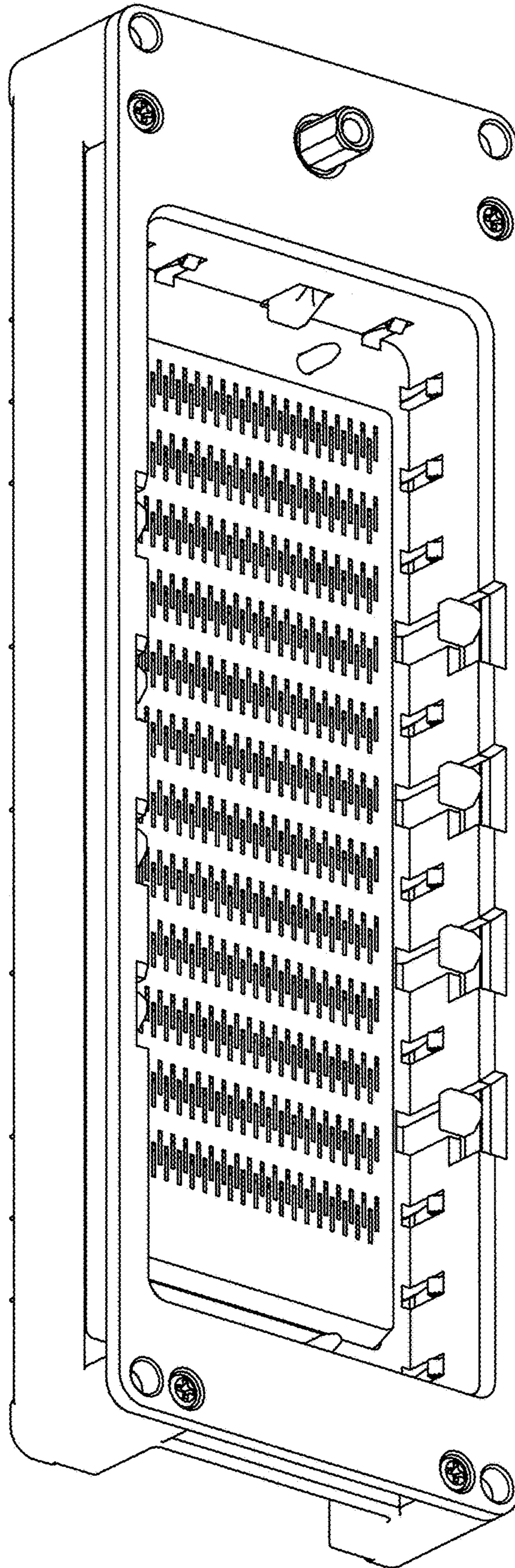

Fig. 9

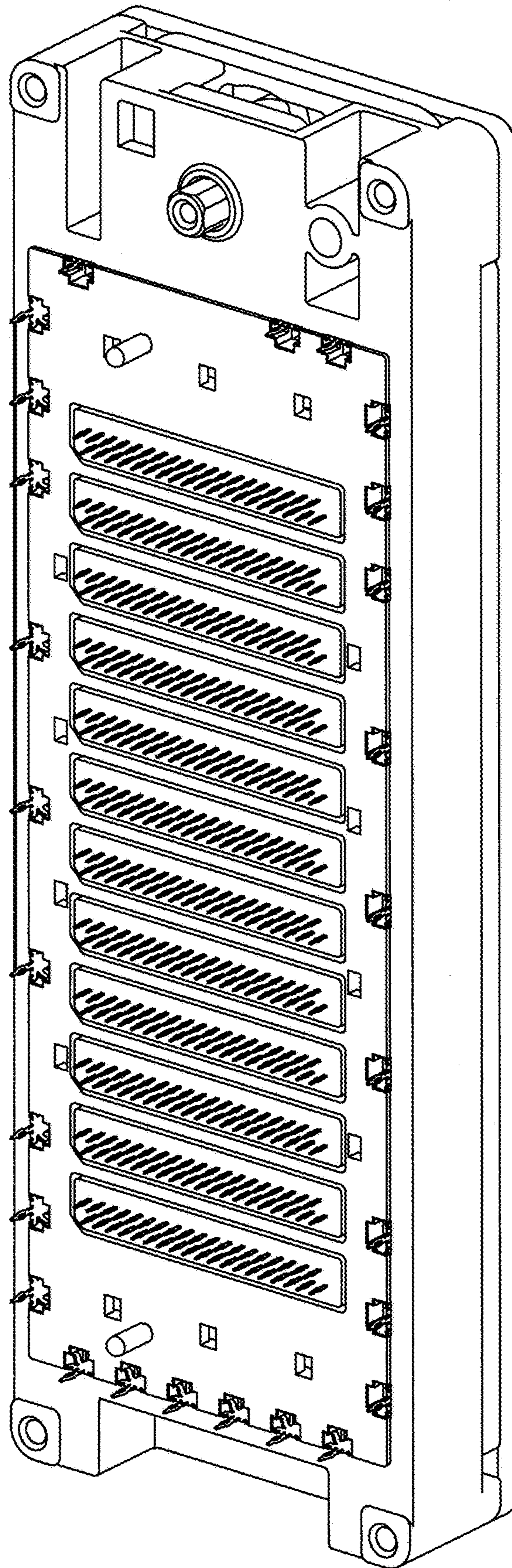



Fig. 10

