



US00D804421S

(12) **United States Design Patent**  
**Sasaki et al.**

(10) **Patent No.:** **US D804,421 S**

(45) **Date of Patent:** **\*\* Dec. 5, 2017**

(54) **ELECTRICAL CONNECTOR**

D436,926 S \* 1/2001 Lew ..... D13/152  
D485,810 S \* 1/2004 Fiocchi ..... D13/184  
D748,068 S \* 1/2016 Weber ..... D13/184

(71) Applicant: **Tyco Electronics Japan G.K.**,  
Kanagawa (JP)

(72) Inventors: **Yohichi Sasaki**, Kanagawa (JP);  
**Makiya Kimura**, Kanagawa (JP)

(73) Assignee: **Tyco Electronics Japan G.K.**,  
Kanagawa-ken (JP)

(\*\*) Term: **15 Years**

(21) Appl. No.: **29/540,787**

(22) Filed: **Sep. 28, 2015**

(30) **Foreign Application Priority Data**

Apr. 28, 2015 (JP) ..... 2015-009507

(51) **LOC (10) Cl.** ..... **13-03**

(52) **U.S. Cl.**  
USPC ..... **D13/147**

(58) **Field of Classification Search**

USPC ..... D13/120, 133, 146, 147, 154, 184, 199  
CPC ..... H01R 12/714; H01R 12/88; H01R 12/89;  
H01R 13/29; H01R 13/40; H01R 13/187;  
H01R 13/193; H01R 13/502; H01R  
13/627; H01R 13/62955; H01R 13/62994;  
H01R 13/639; H01R 13/6581; H01R  
13/6585; H01R 13/6588

See application file for complete search history.

(56) **References Cited**

U.S. PATENT DOCUMENTS

D31,836 S \* 11/1899 Heib ..... D13/154  
D397,097 S \* 8/1998 McNally ..... D13/173

FOREIGN PATENT DOCUMENTS

JP 1309445 S 9/2007  
JP 1372934 S 11/2009  
JP 1372936 S 11/2009

\* cited by examiner

*Primary Examiner* — Daniel Bui

(74) *Attorney, Agent, or Firm* — Barley Snyder

(57) **CLAIM**

The ornamental design for an electrical connector, as shown and described.

**DESCRIPTION**

FIG. 1 is a front elevation view of an electrical connector, showing our new design;  
FIG. 2 is a top plan view thereof;  
FIG. 3 is a rear elevation view thereof;  
FIG. 4 is a bottom plan view thereof;  
FIG. 5 is a right side elevation view thereof;  
FIG. 6 is a left side elevation view thereof;  
FIG. 7 is a front, top and right perspective view thereof;  
FIG. 8 is a rear, top and left perspective view thereof  
FIG. 9 is a front, bottom and left perspective view thereof;  
and,  
FIG. 10 is a rear, bottom and right perspective view.

**1 Claim, 10 Drawing Sheets**

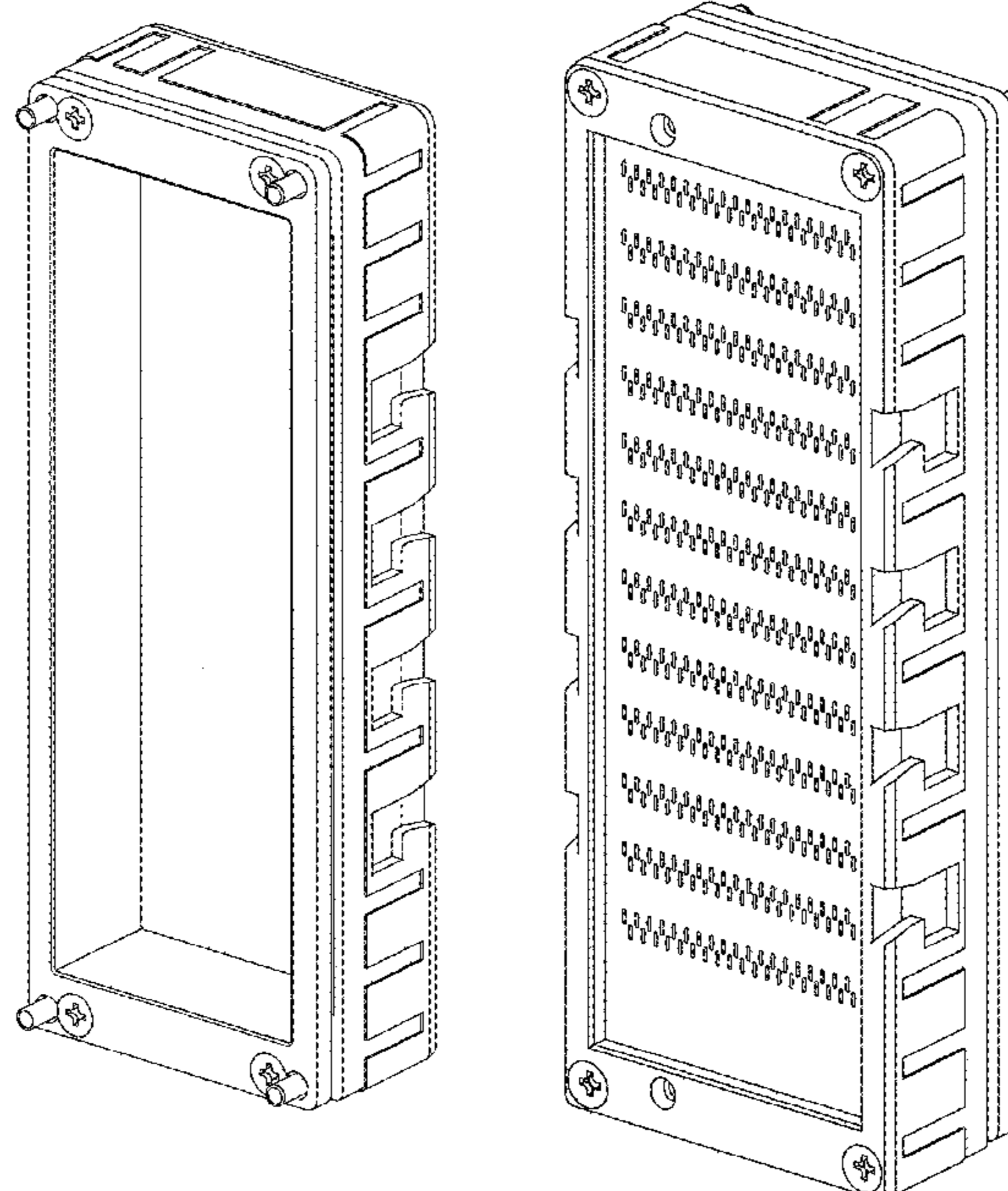

Fig. 1

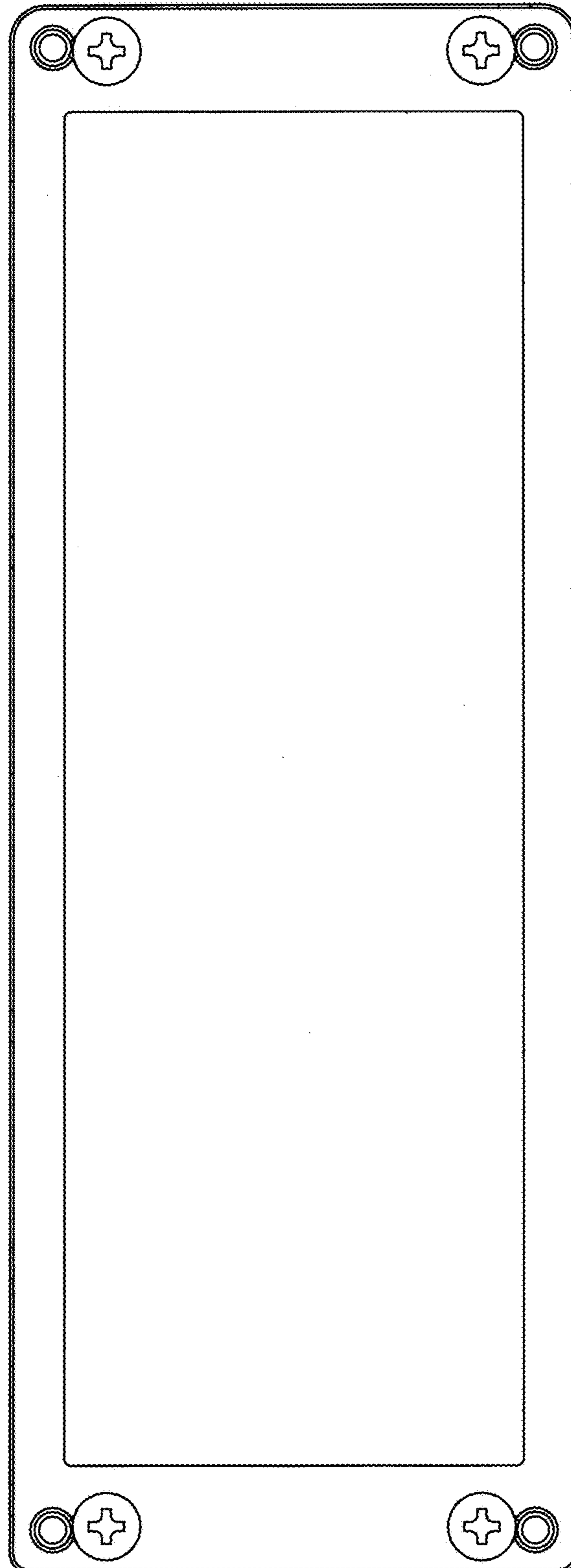

Fig. 2

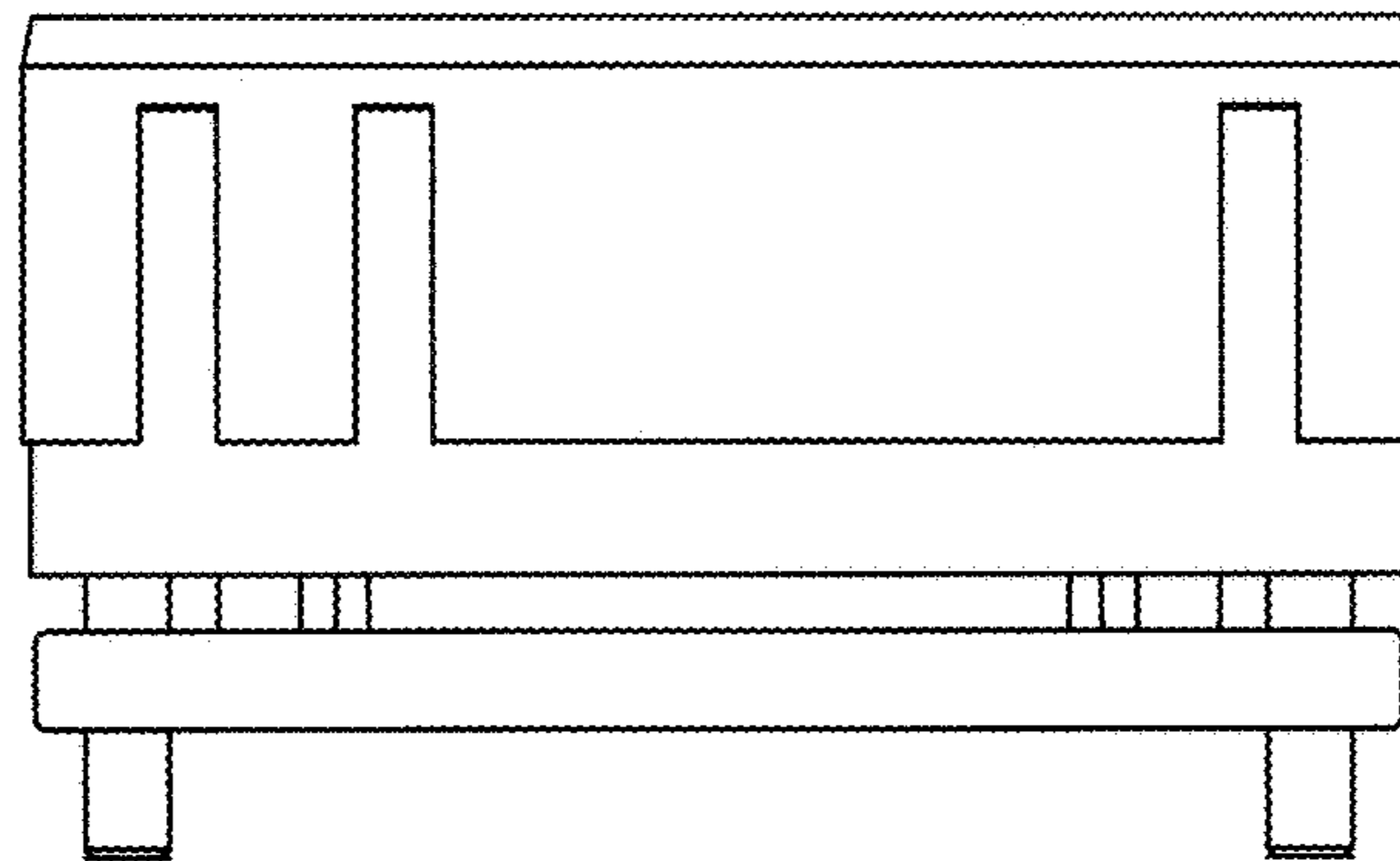

Fig. 3

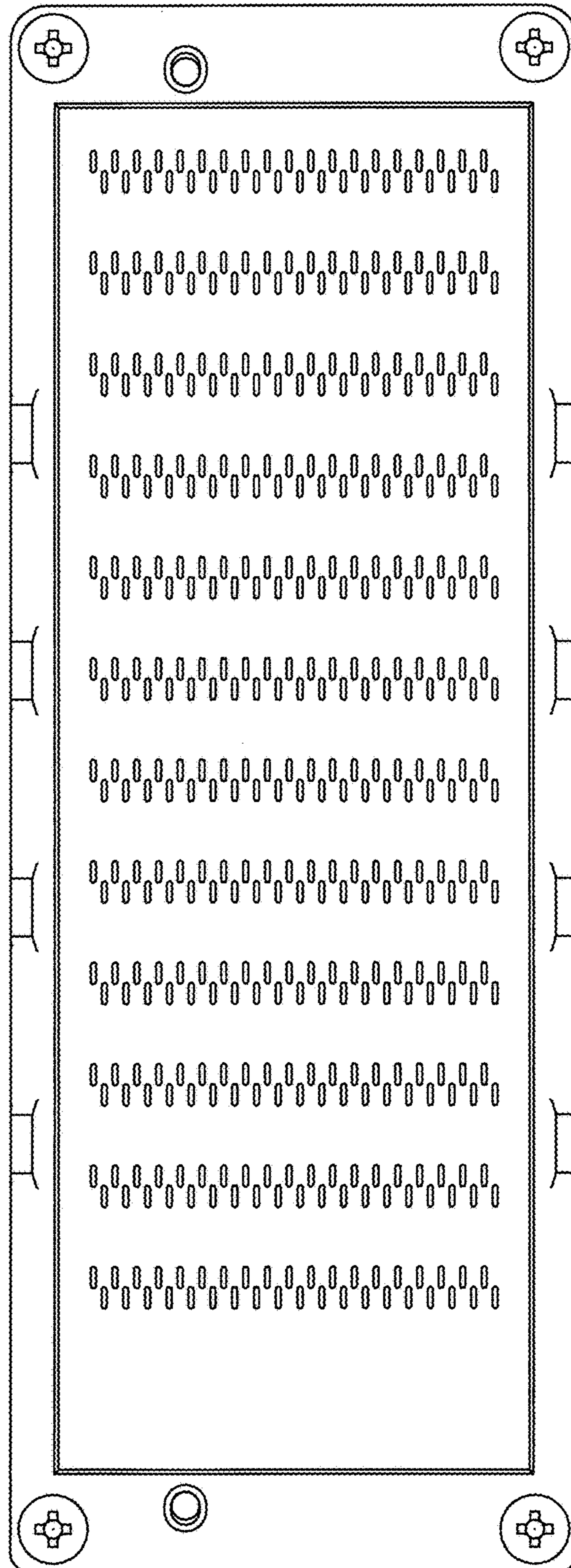

Fig. 4

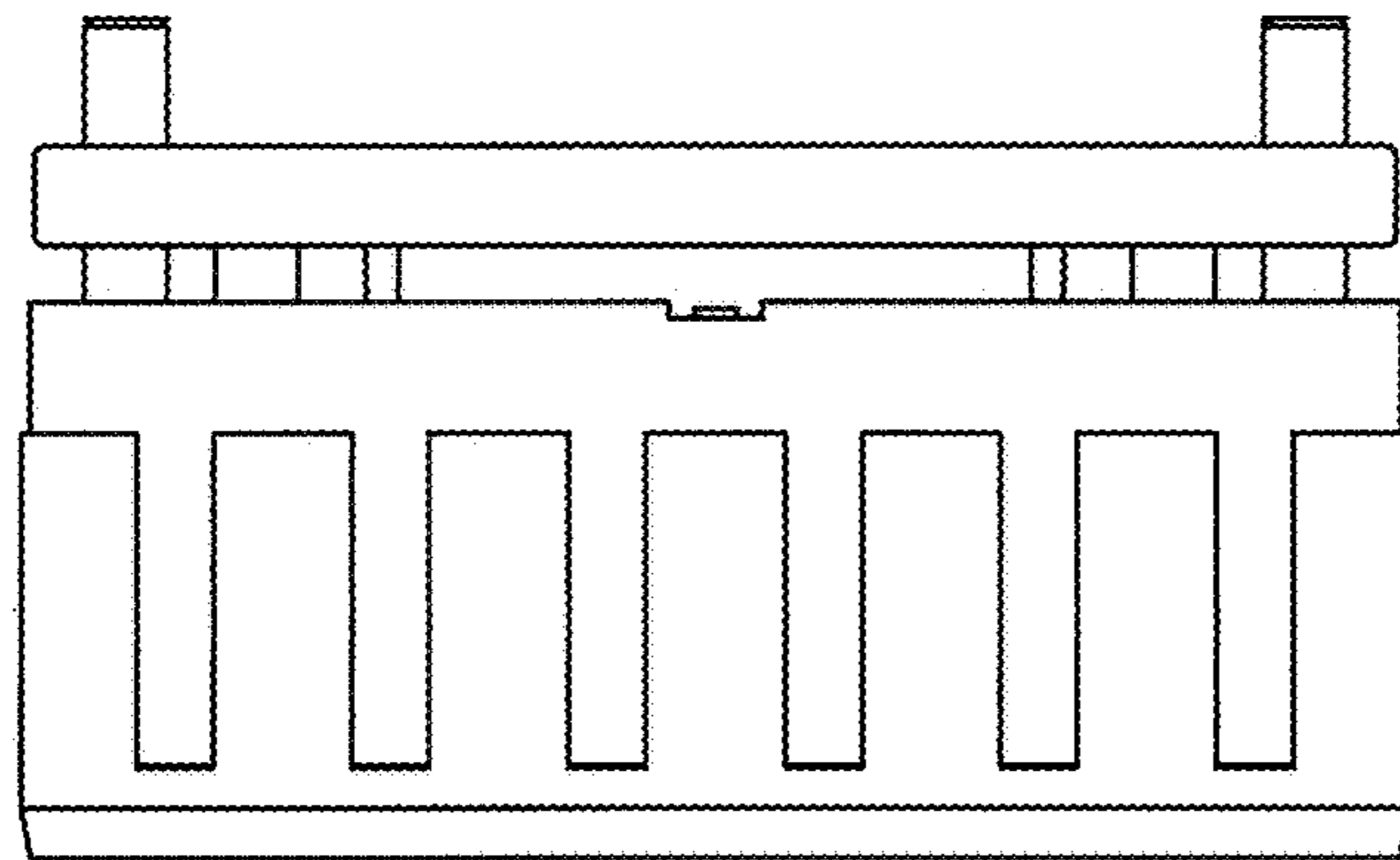



Fig. 5

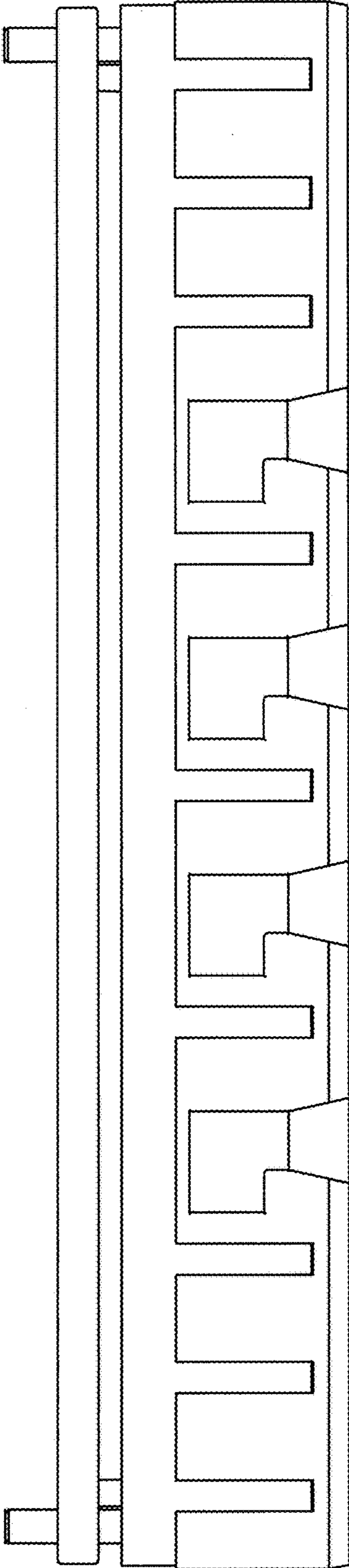

Fig. 6

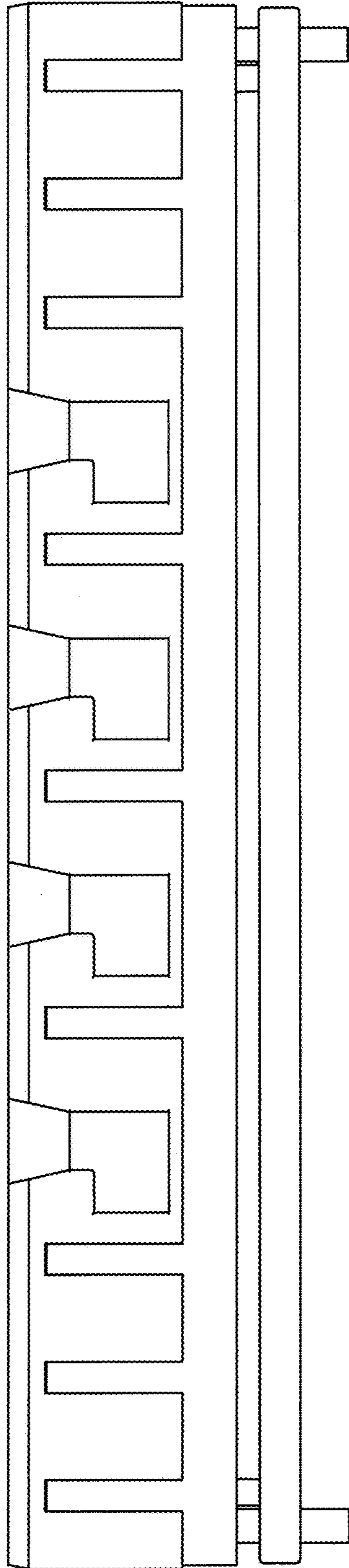

Fig. 7

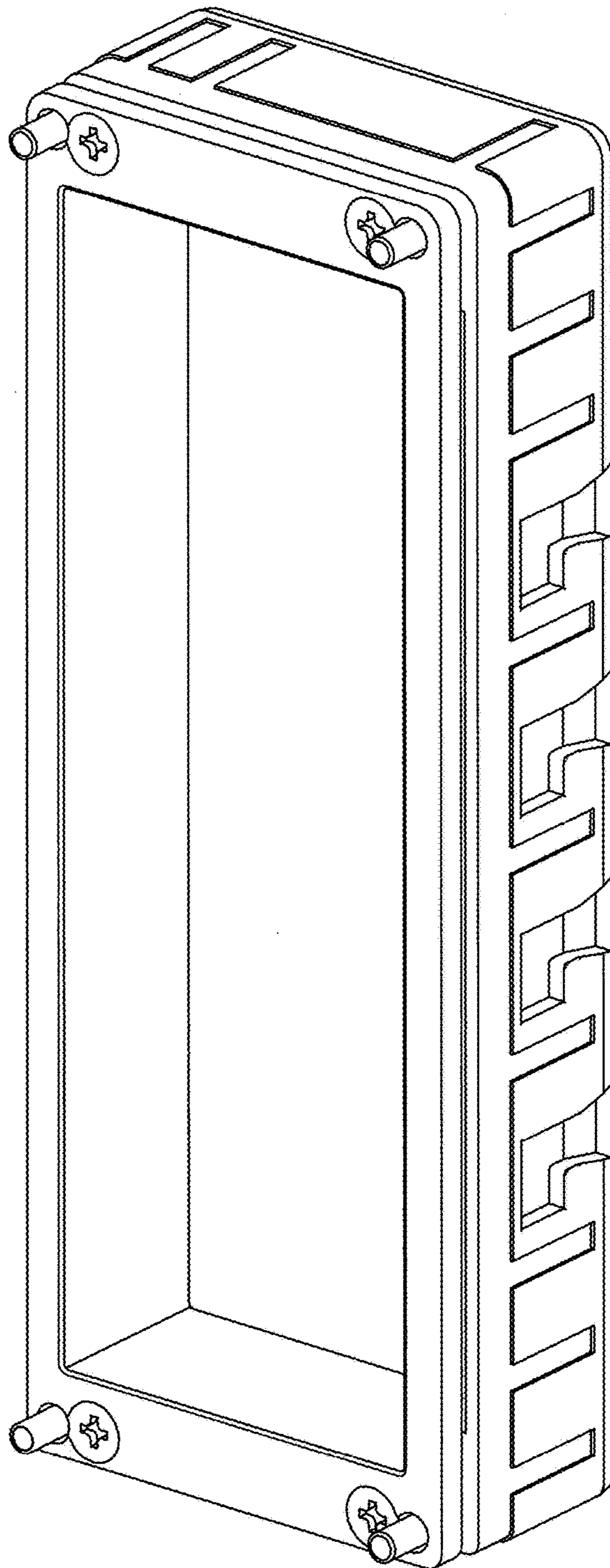



Fig. 8

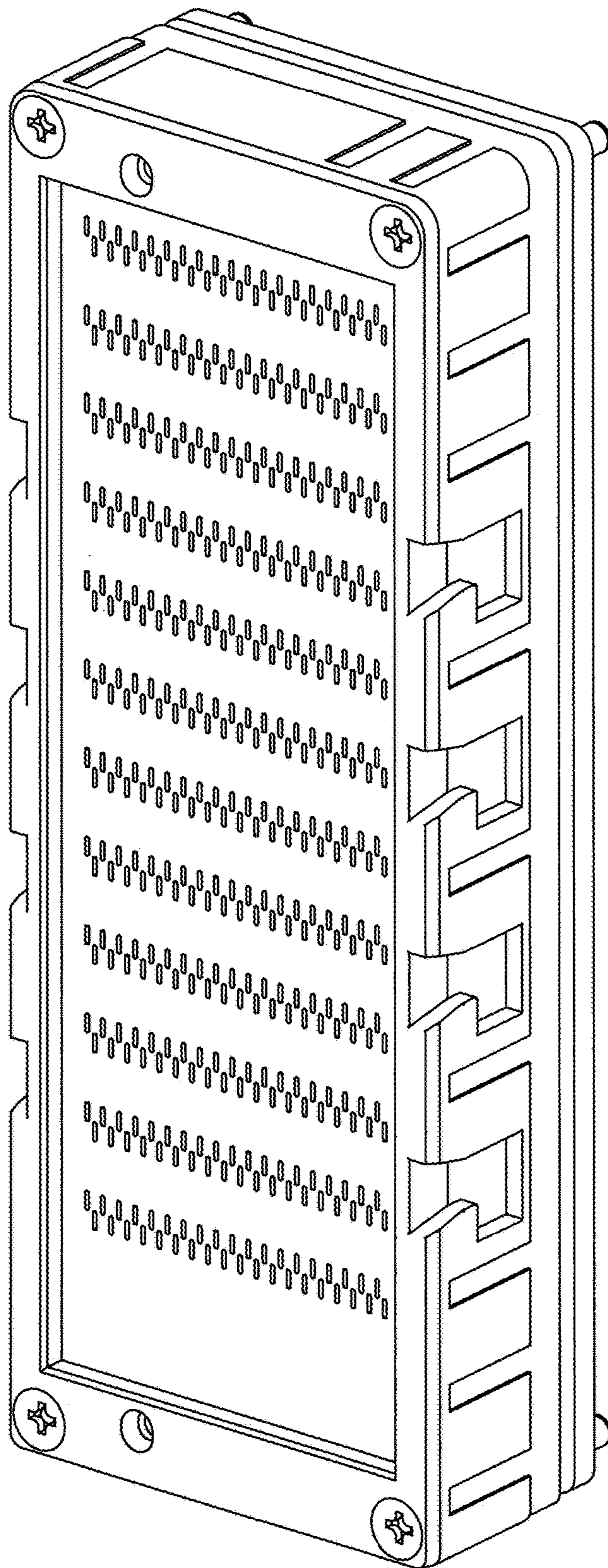

Fig. 9

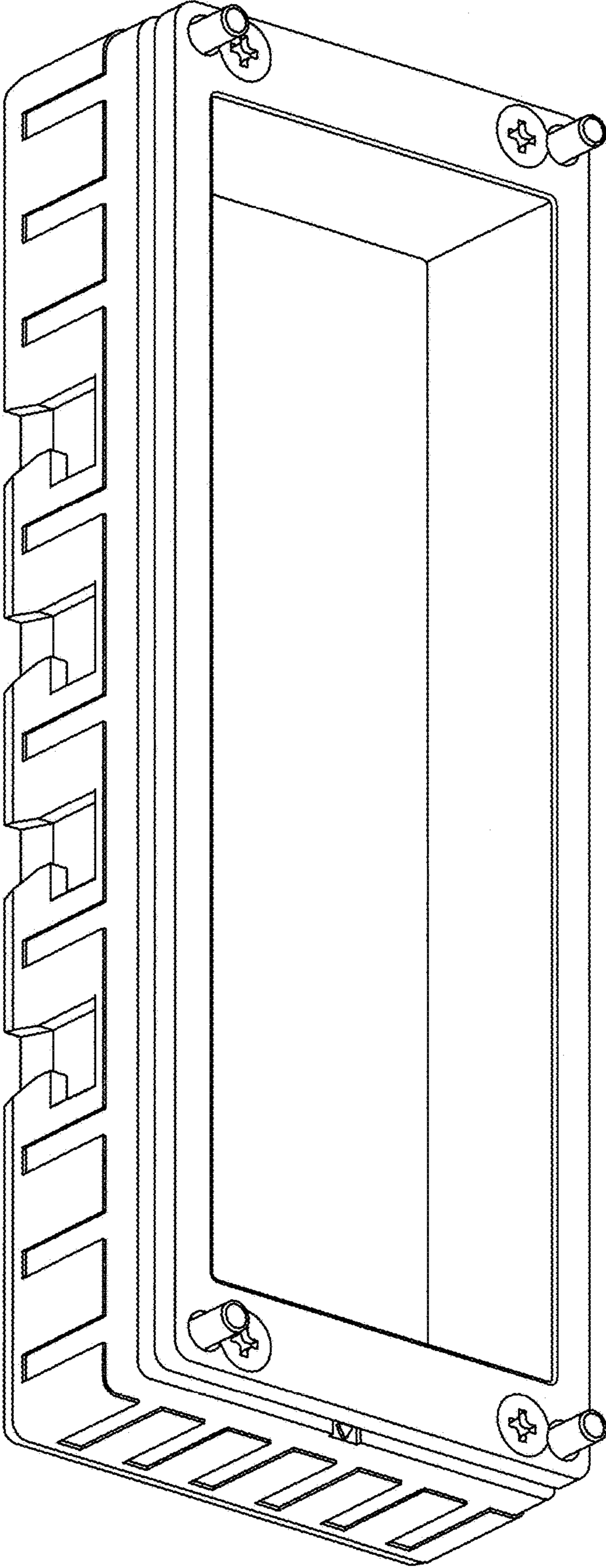

Fig. 10

