



US00D804319S

(12) **United States Design Patent** (10) **Patent No.:** **US D804,319 S**  
**Galekovic** (45) **Date of Patent:** **\*\* Dec. 5, 2017**

- (54) **CAPSULE**
- (71) Applicant: **Beard King Corp.**, Bal Harbour, GA (US)
- (72) Inventor: **Nicholas Galekovic**, Bal Harbour, FL (US)
- (\*\*) Term: **15 Years**
- (21) Appl. No.: **29/593,950**
- (22) Filed: **Feb. 14, 2017**
- (51) **LOC (10) Cl.** ..... **09-01**
- (52) **U.S. Cl.**  
USPC ..... **D9/553**
- (58) **Field of Classification Search**  
USPC ..... D9/516, 519, 520, 521, 527, 528, 529, D9/530, 531, 533, 540, 542, 550, 553, D9/556, 557, 558, 559, 563, 564, 565, D9/566, 567, 545, 536, 537, 538, 539, D9/541, 543, 522; D3/202, 203.1, 205; D4/114; D6/515, 542; D7/300, 300.1, D7/598  
CPC ..... B65D 2501/0009; B65D 2501/00; B65D 23/00; B65D 1/0223; B65D 1/00; B65D 1/02  
See application file for complete search history.

- D662,827 S \* 7/2012 Watabe ..... D9/453
- D769,722 S \* 10/2016 Oymak ..... D9/556
- D772,204 S \* 11/2016 Tsou ..... D14/223

OTHER PUBLICATIONS

Trvel Kit, [online], [site visited Aug. 25, 2017]. Available from Internet, URL <https://thebeardking.com/collections/beard-king-products/products/travel-kit>.\*

King Capsule Beard King, [online], [site visited Aug. 25, 2017]. Available from Internet, URL:<https://thebeardking.com/products/king-capsule>.\*

\* cited by examiner

*Primary Examiner* — Caron D Veynar  
*Assistant Examiner* — Katrina N Gonzalez  
 (74) *Attorney, Agent, or Firm* — Grant Attorneys at Law PLLC; Kristin A. Grant

(57) **CLAIM**

The ornamental design for a capsule, as shown and described.

**DESCRIPTION**

FIG. 1 is a perspective view of a capsule showing my new design;  
 FIG. 2 is a right elevational view thereof;  
 FIG. 3 is a left elevational view thereof;  
 FIG. 4 is a rear elevational view thereof;  
 FIG. 5 is a front elevational view thereof;  
 FIG. 6 is a top plan view thereof;  
 FIG. 7 is a bottom plan view thereof;  
 FIG. 8 is an exploded perspective view of FIG. 1; and,  
 FIG. 9 is an exploded perspective view of FIG. 1, shown in an open configuration with unclaimed interior portions removed.  
 The broken lines are shown for the purpose of illustrating portions of the capsule that form no part of the claimed design.

**1 Claim, 8 Drawing Sheets**

(56) **References Cited**

U.S. PATENT DOCUMENTS

- D146,916 S \* 6/1947 Hornung ..... 3/205
- D146,918 S \* 6/1947 Hornung ..... 3/205
- D147,254 S \* 8/1947 Streng ..... D27/189
- D166,526 S \* 4/1952 Buckingham ..... D9/443
- D255,654 S \* 7/1980 Goss ..... D9/529
- D274,209 S \* 6/1984 Kikuchi ..... 7/608
- D306,246 S \* 2/1990 Rauch ..... D7/300
- D311,298 S \* 10/1990 Mollenhoff ..... D7/300
- D359,690 S \* 6/1995 Heinz ..... D9/545
- D595,584 S \* 7/2009 Yamamoto ..... D9/529

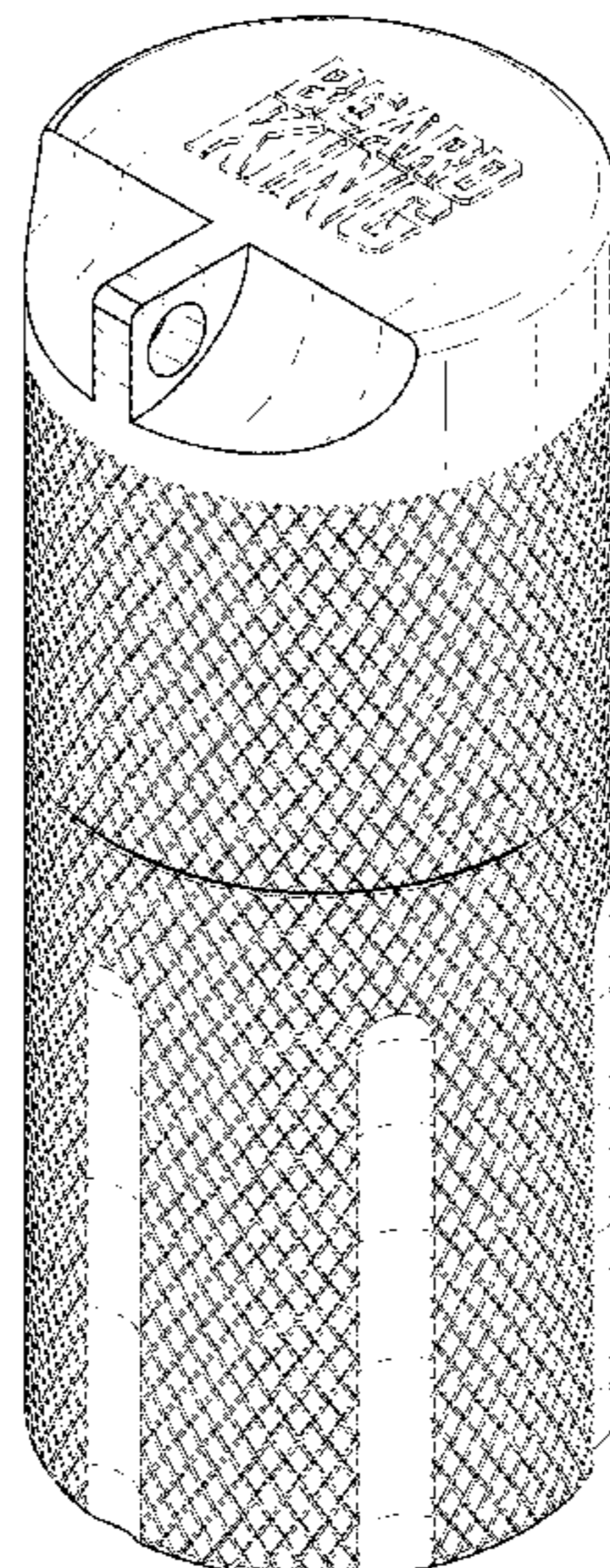

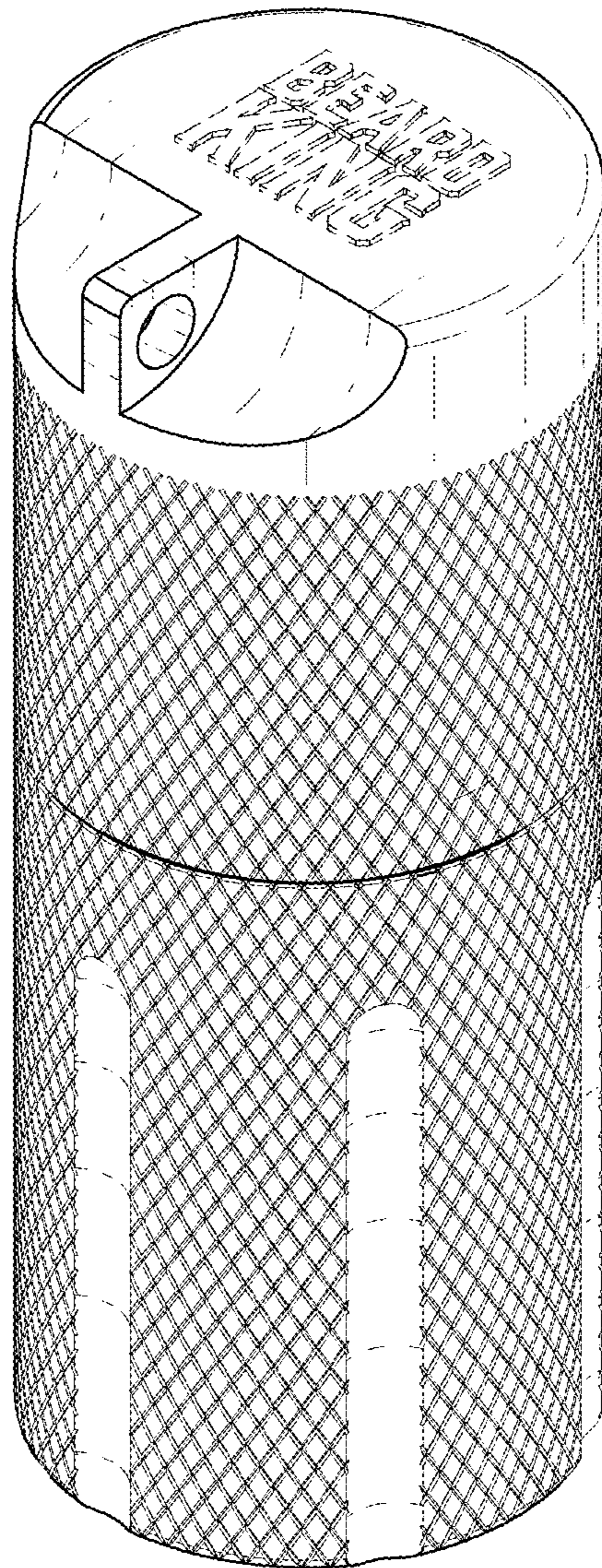
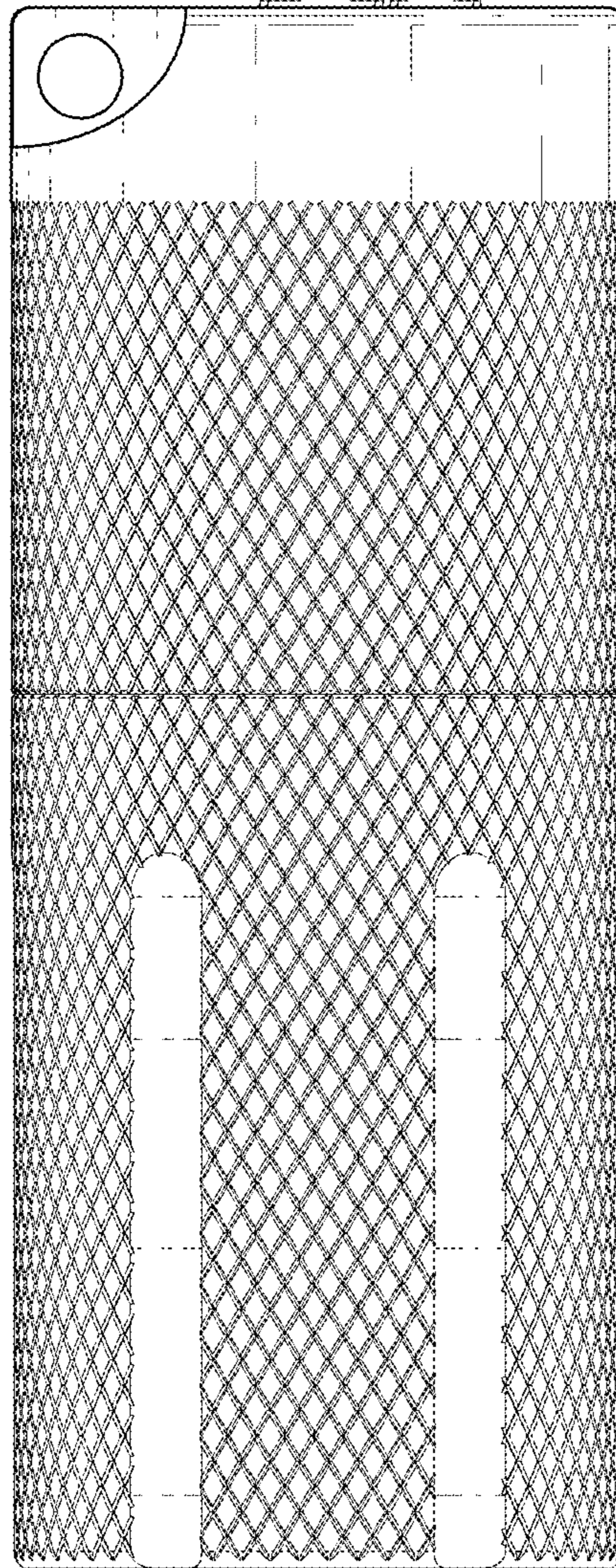
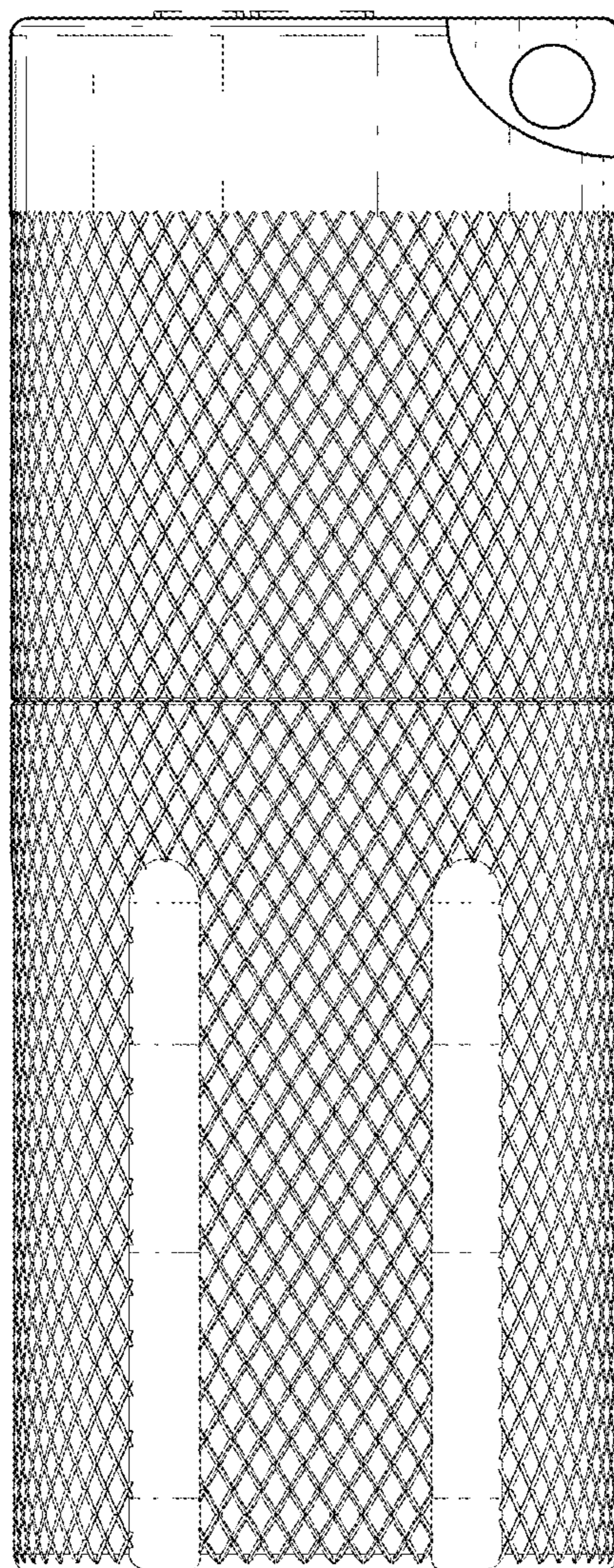

FIG. 1



*FIG. 2*



*FIG. 3*

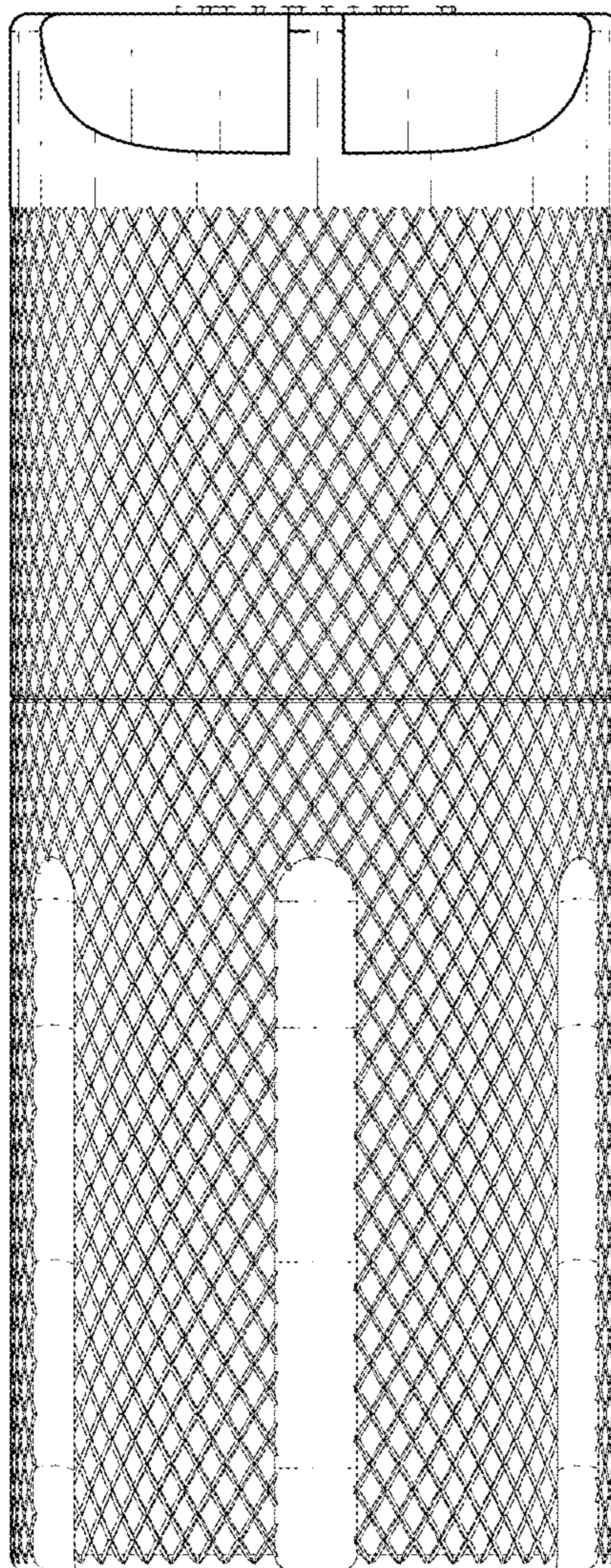

*FIG. 4*

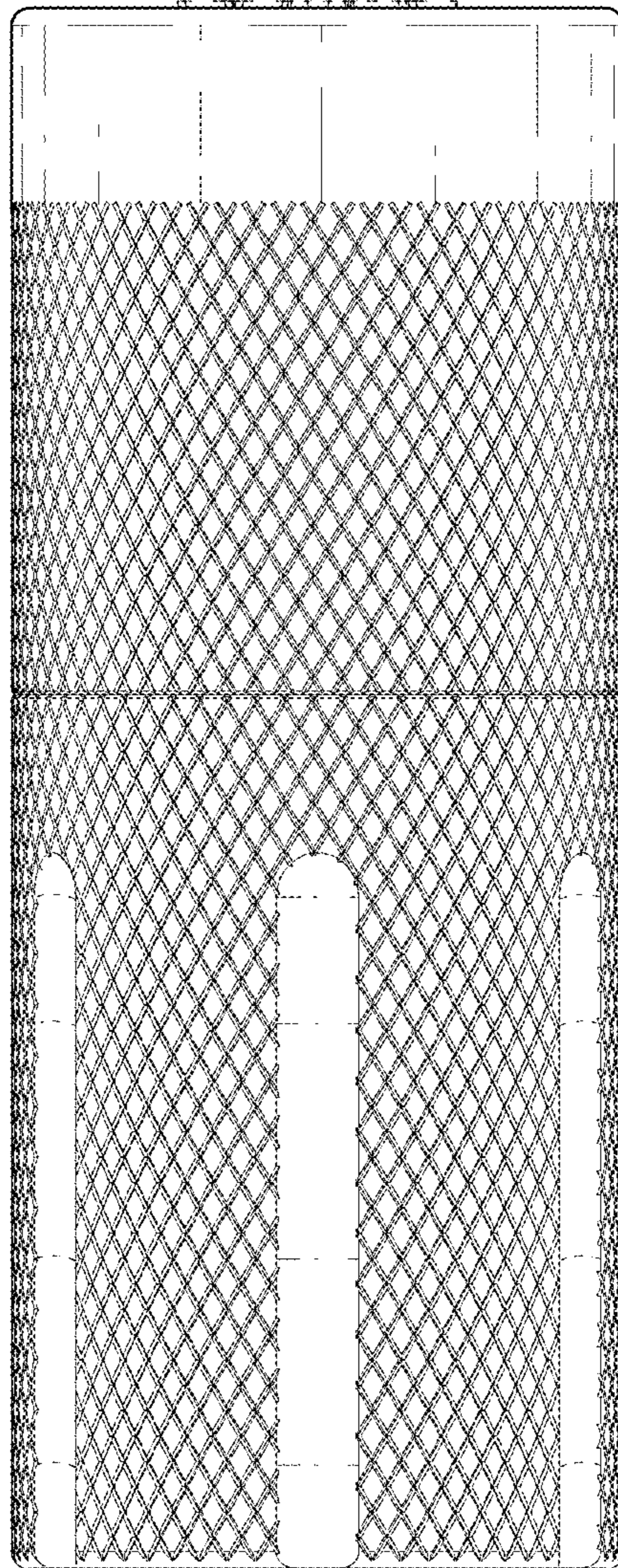

*FIG. 5*

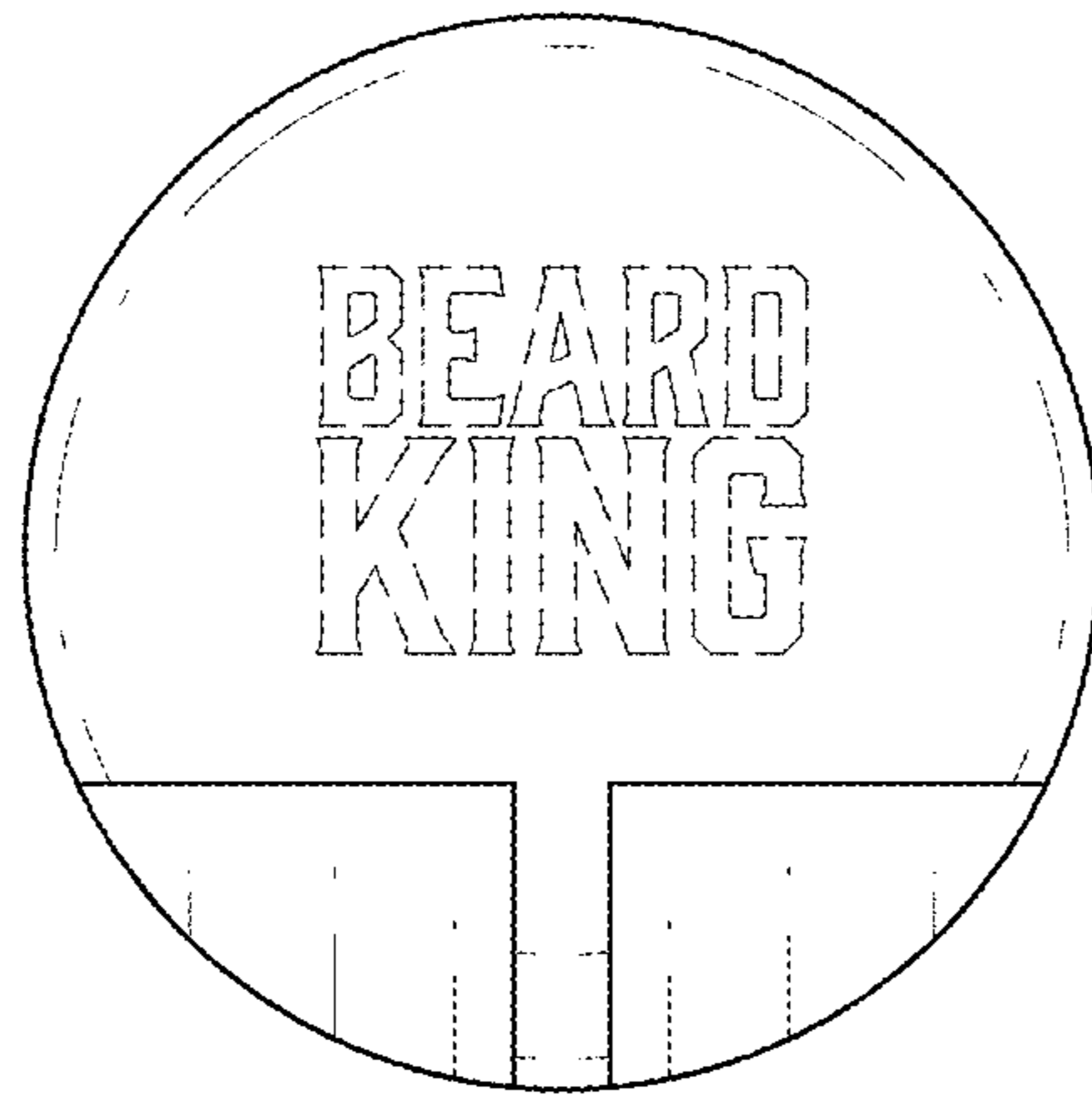

*FIG. 6*

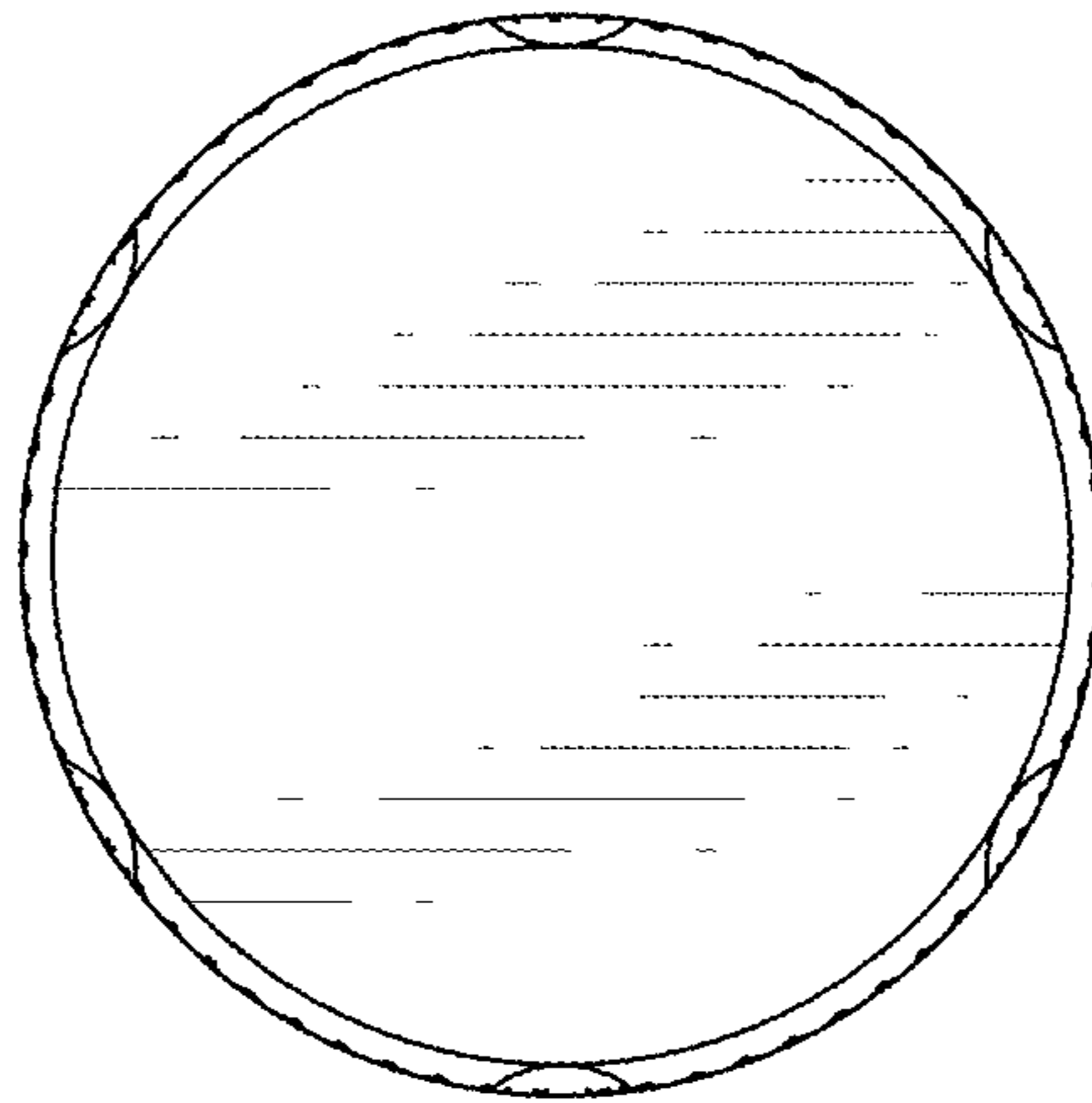

*FIG. 7*

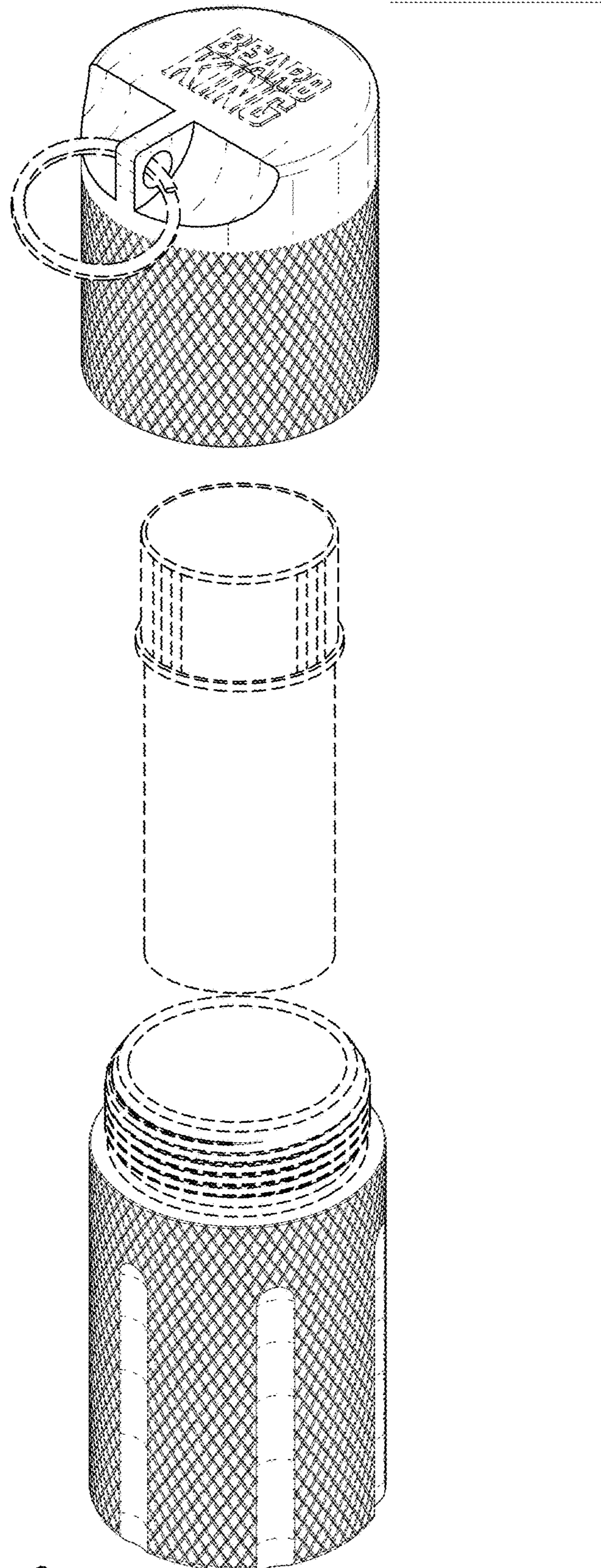

FIG. 8



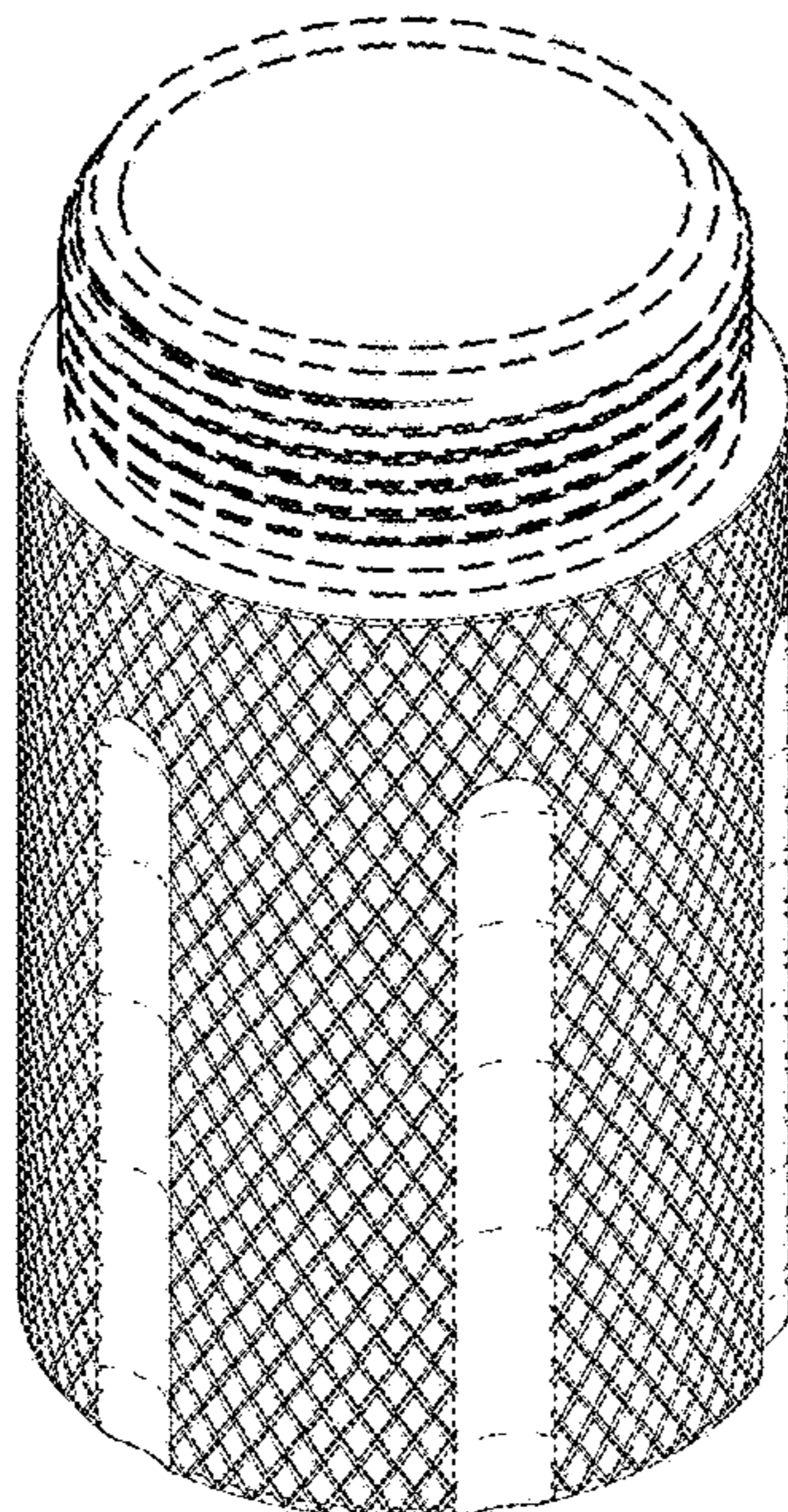
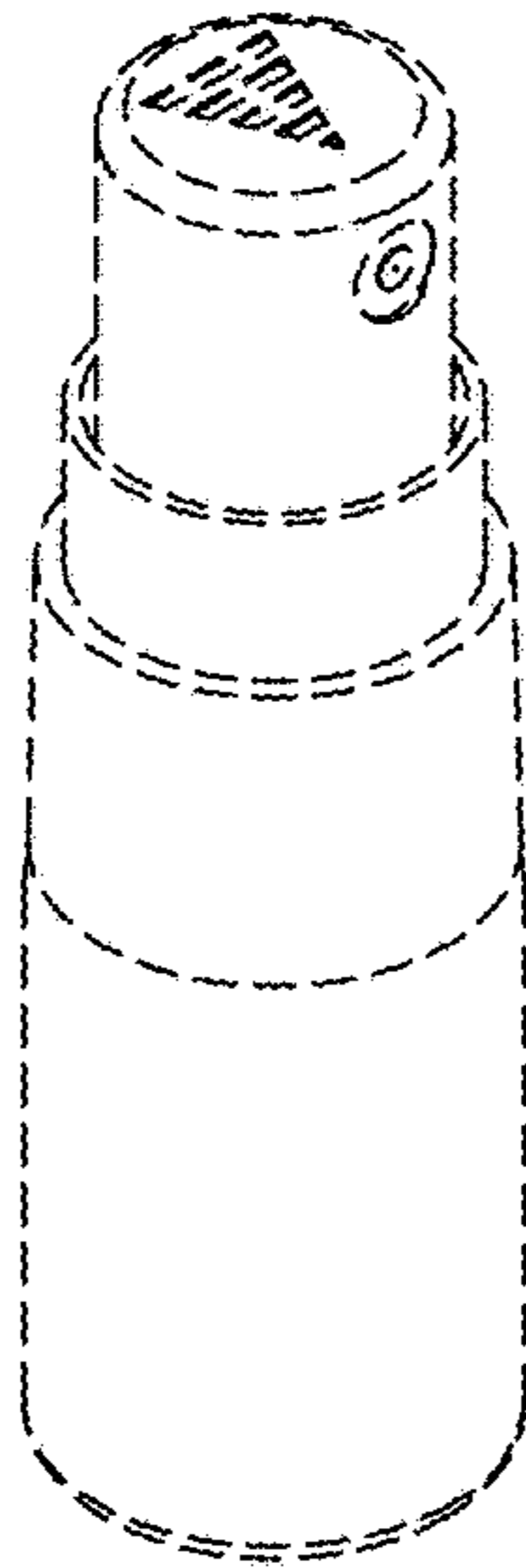
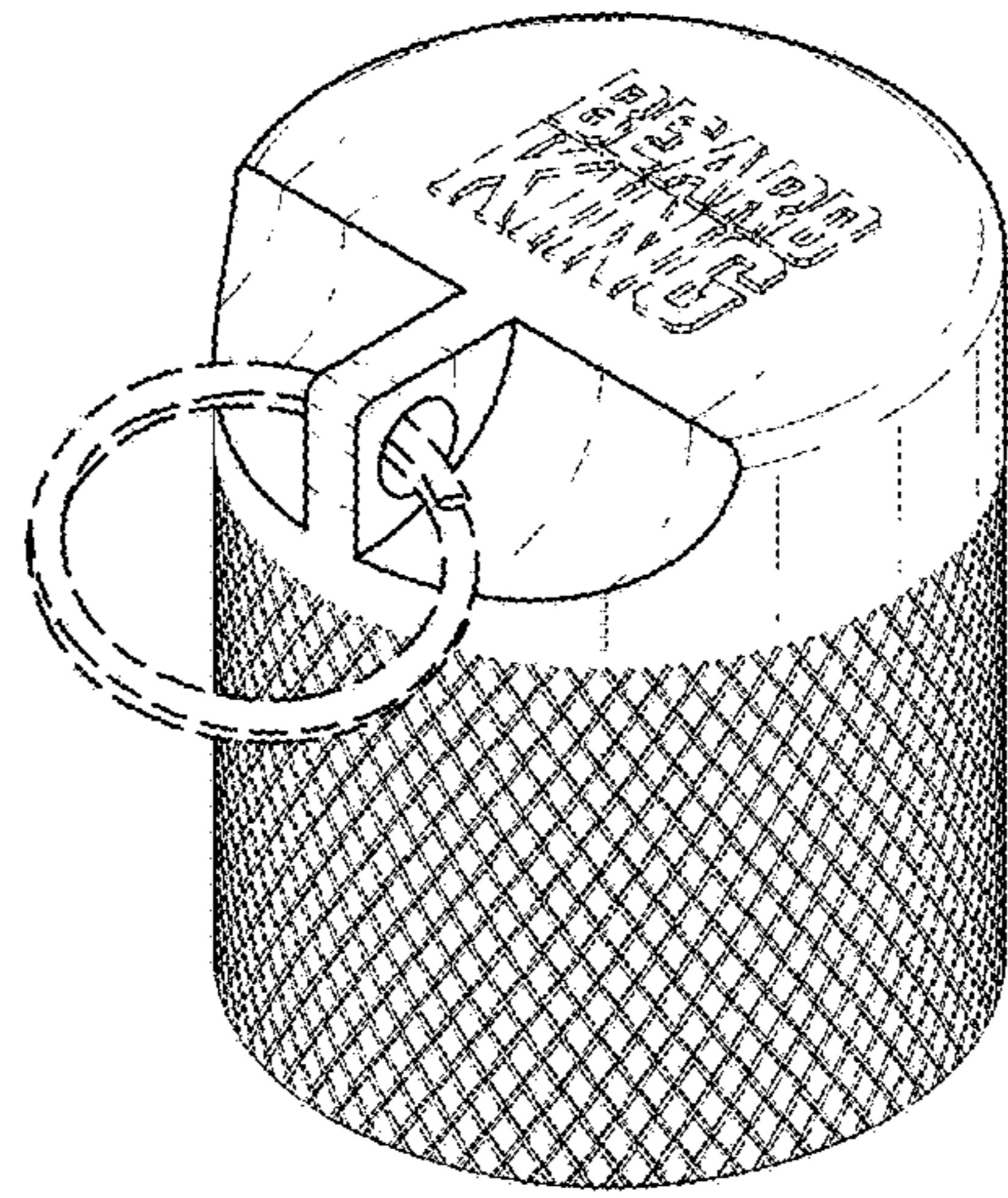

FIG. 9