



US00D804315S

(12) **United States Design Patent** (10) **Patent No.:** **US D804,315 S**
Galvin et al. (45) **Date of Patent:** **** Dec. 5, 2017**

(54) **BOTTLE**
(71) Applicant: **PepsiCo, Inc.**, Purchase, NY (US)

D90,649 S 7/1933 Fleisch
D93,630 S 8/1933 Merolle
D97,465 S 3/1935 Conner
(Continued)

(72) Inventors: **Ian Galvin**, Chicago, IL (US);
Raymundo Martinez, Berwyn, IL (US); **Katie Ozamiz**, Chicago, IL (US);
Wade Fournier, Chicago, IL (US)

FOREIGN PATENT DOCUMENTS

CA 106315 3/2006
GB 4000790 12/2006
(Continued)

(73) Assignee: **PepsiCo, Inc.**, Purchase, NY (US)

(**) Term: **15 Years**

OTHER PUBLICATIONS

(21) Appl. No.: **29/582,183**

Aveeno. Online, published date unknown. Retrieved on Aug. 31, 2017 from URL: <http://www.ulta.com/daily-moisturizing-lotion?productId=xlsImpprod3190091>.*

(22) Filed: **Oct. 25, 2016**

(51) **LOC (10) Cl.** **09-01**

(52) **U.S. Cl.**

USPC **D9/542**

(58) **Field of Classification Search**

USPC D9/434-435, 439, 447, 449, 450, 452,
D9/454, 516, 520, 522-524, 528-531,
D9/541-544, 549-551, 558-560, 563,
D9/565-566, 571-575, 682, 686, 687,
D9/693-694, 715, 719; D7/300, 300.1,
D7/316, 317, 598; D23/211, 225

CPC ... B65D 1/00; B65D 1/02; B65D 1/12; B65D
1/18; B65D 1/20; B65D 1/0223; B65D
23/00; B65D 21/0237; B65D 2501/0009;
B65D 2501/0081

See application file for complete search history.

Primary Examiner — Vy N Koenig

Assistant Examiner — Omeed Agilee

(74) *Attorney, Agent, or Firm* — Sterne, Kessler,
Goldstein & Fox P.L.L.C.

(57) **CLAIM**

The ornamental design for a bottle, as shown and described.

DESCRIPTION

FIG. 1 is a top front perspective view of a bottle showing the claimed design;

FIG. 2 is a bottom rear perspective view of a bottle showing the claimed design;

FIG. 3 is a front view thereof;

FIG. 4 is a rear view thereof;

FIG. 5 is a left side view thereof;

FIG. 6 is a right side view thereof;

FIG. 7 is a top view thereof; and,

FIG. 8 is a bottom view thereof.

The dashed broken lines in the figures show portions of the bottle that form no part of the claimed design.

The dot-dash broken lines in the figures show boundaries that form no part of the claimed design.

(56) **References Cited**

U.S. PATENT DOCUMENTS

D19,798 S 4/1890 Wardle
D29,673 S 11/1898 Nightingale
D51,893 S 3/1918 Temple
D56,983 S 1/1921 Lewis
D74,502 S 12/1926 Ginter
D84,239 S 5/1931 Furest
D86,280 S 2/1932 Smith
D86,816 S 4/1932 Von Till

1 Claim, 7 Drawing Sheets

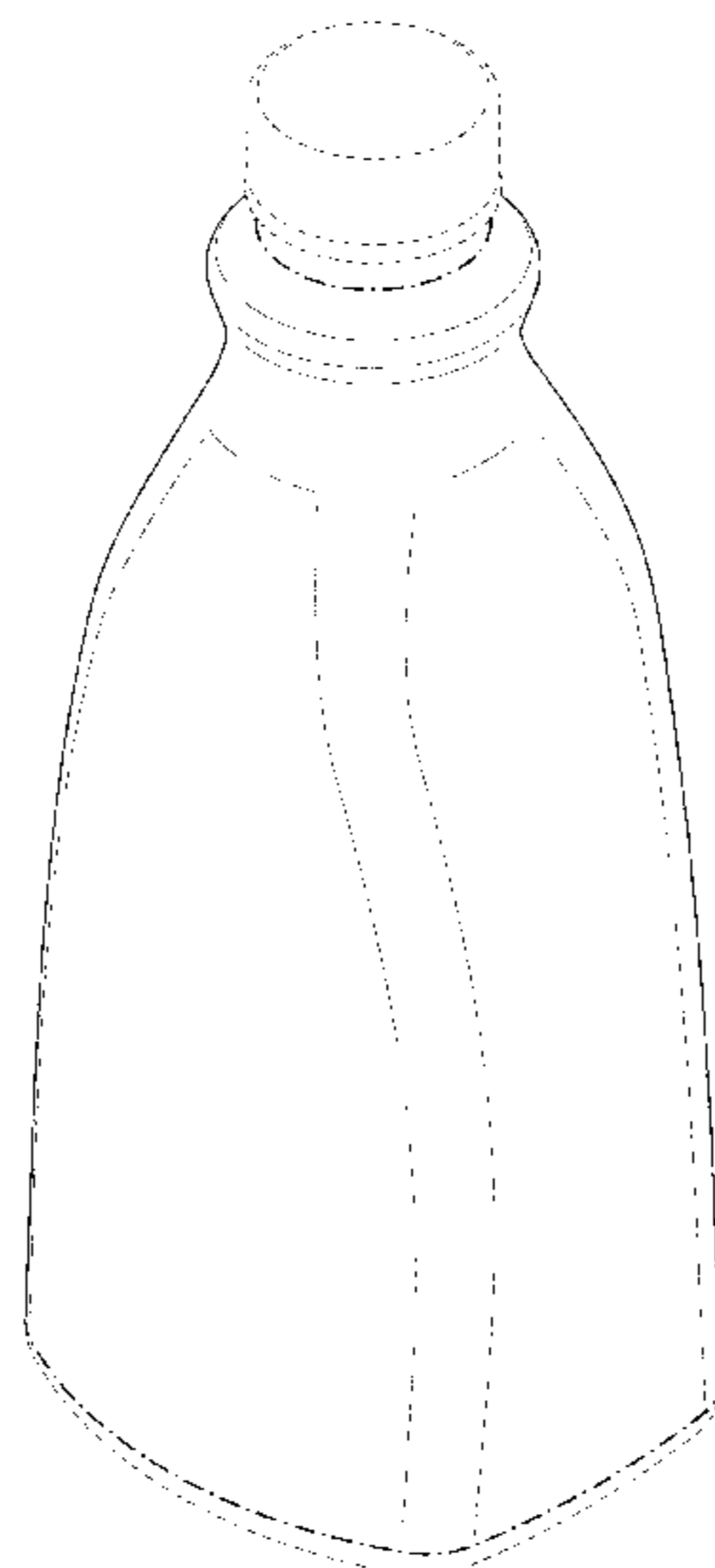

(56)

References Cited

U.S. PATENT DOCUMENTS

D103,774 S	3/1937	Funkey	
D103,987 S	4/1937	Ennever	
D109,518 S	1/1938	Meier	
D111,962 S	11/1938	Frank	
D113,133 S	1/1939	De Nero	
D115,430 S	6/1939	Street	
D119,303 S	3/1940	Deletzke	
D136,438 S	3/1943	Tatro	
D144,500 S	4/1946	Frederics	
D149,617 S	5/1948	Conman	
D155,868 S	11/1949	Braun	
D178,808 S	9/1956	Rosenak	
D192,942 S	5/1962	DuPree	
3,323,668 A	6/1967	Hills	
D208,332 S	8/1967	Marona	
D212,672 S	1/1968	Weckman	
D212,357 S *	10/1968	Rohde	D24/224
D212,463 S	10/1968	Vanderhyde	
3,403,804 A	10/1968	Colombo	
D213,038 S	12/1968	Pettengill	
D213,767 S	4/1969	Fuerst	
D216,459 S	1/1970	Viitanen	
D216,540 S	2/1970	Douglas	
D217,803 S	6/1970	Douglas	
D232,079 S	7/1974	Luedtke	
D233,828 S	12/1974	Leary	
D236,587 S	9/1975	Kretz	
D261,104 S	10/1981	Cohen Skalli	
D263,562 S	3/1982	Cincala	
D265,058 S	6/1982	Ewry	
D265,550 S	7/1982	Young et al.	
D286,021 S	10/1986	O'Reilly	
D287,933 S *	1/1987	Mills	D9/500
D292,380 S	10/1987	Smith	
D308,483 S	6/1990	Weckman	
4,993,565 A	2/1991	Ota et al.	
D315,293 S	3/1991	Moglia	
5,037,684 A	8/1991	Dundas et al.	
D322,213 S	12/1991	Maginnis	
D325,347 S	4/1992	Doering	
5,123,554 A	6/1992	Aividson et al.	
D328,245 S	7/1992	Noble	
D329,868 S	9/1992	Sakaguchi et al.	
D333,425 S	2/1993	Boussiquet	
5,261,544 A	11/1993	Weaver, Jr.	
D343,793 S	2/1994	Crawford	
D346,548 S	5/1994	Maddox	
D352,461 S	11/1994	Flanagan et al.	
D352,891 S	11/1994	Lalique	
5,370,250 A	12/1994	Gilbert	
D356,506 S	3/1995	Kornick et al.	
D356,871 S	3/1995	Dunn	
D362,799 S	10/1995	Noble	
D365,752 S	1/1996	Flanagan-Boos et al.	
D375,900 S	11/1996	DeVore	
D384,890 S	10/1997	Goldman	
D387,670 S	12/1997	Larkin	
5,908,127 A	1/1999	Weick	
D415,964 S	2/1999	Manderfield, Jr. et al.	
D411,740 S	6/1999	Kim	
D413,265 S	8/1999	Hestehave et al.	
D413,511 S	9/1999	Guthrie et al.	
D420,588 S	2/2000	Fitelson et al.	
D422,493 S	4/2000	Clarke	
D425,793 S	5/2000	Walker	
D427,513 S	6/2000	Boisset	
D437,226 S	2/2001	Sadeghietal	
D442,089 S	5/2001	Sadeghietal	
D443,513 S	6/2001	Goettner	
D447,698 S	9/2001	Kaufman	
D449,539 S	10/2001	Lakatosh et al.	
D452,650 S	1/2002	Moore et al.	
D456,272 S	4/2002	Sadeghietal	
D457,437 S	5/2002	Sadeghietal	
D458,145 S	6/2002	Sadeghietal	
D458,146 S	6/2002	Sadeghietal	
D458,147 S	6/2002	Sadeghietal	
D458,148 S	6/2002	Sadeghietal	
D460,695 S	7/2002	Sadeghietal	
D463,281 S	9/2002	Oruitt	
D463,287 S	9/2002	Moore et al.	
D465,730 S	11/2002	Oruitt	
D468,213 S	1/2003	Moore et al.	
D477,066 S	7/2003	Lonczak et al.	
D480,315 S	10/2003	Sadeghietal	
D480,644 S	10/2003	Oruitt	
D483,675 S	12/2003	Lindsay et al.	
D488,060 S	4/2004	Yourist	
D489,991 S	5/2004	Deubel et al.	
D491,068 S	6/2004	Heliste et al.	
D492,201 S	6/2004	Pritchett et al.	
6,783,014 B2	8/2004	Luker	
D496,282 S	9/2004	Heliste et al.	
D500,677 S	1/2005	Druitt	
D509,740 S *	9/2005	Collins	D9/516
D509,984 S	9/2005	Zboch et al.	
D510,026 S	9/2005	Nelson et al.	
D510,523 S	10/2005	Pitman et al.	
6,997,336 B2	2/2006	Yourist et al.	
7,017,763 B2	3/2006	Kelley	
D525,141 S	6/2006	Beard et al.	
D525,529 S	7/2006	Oguchi et al.	
D526,209 S	8/2006	Beard et al.	
D526,210 S	8/2006	Beard et al.	
D526,905 S	8/2006	Beard et al.	
7,097,061 B2	8/2006	Simpson et al.	
D530,217 S	10/2006	Krause	
D531,042 S	10/2006	Venkataraman et al.	
D533,408 S	12/2006	Jackson et al.	
D533,786 S	12/2006	Ogg et al.	
D534,808 S	1/2007	Haubert, III et al.	
D535,189 S	1/2007	Pitman et al.	
D536,257 S	2/2007	Weber	
D538,464 S	3/2007	Chen	
D539,158 S	3/2007	Miller et al.	
D539,159 S	3/2007	Slat et al.	
D542,656 S	5/2007	Szczesniak	
D542,669 S	5/2007	Arthur et al.	
D544,364 S	6/2007	Archeny et al.	
D547,198 S	7/2007	Eaton et al.	
D547,665 S	7/2007	Lepoitevin	
D547,670 S	7/2007	Heisner	
D548,092 S	8/2007	Klemm	
D555,500 S	11/2007	Johnston et al.	
D560,508 S	1/2008	Lepoitevin	
D561,040 S	2/2008	Sequeira	
D562,146 S	2/2008	Zboch et al.	
D565,422 S *	4/2008	Cowan-Hughes	D9/563
D566,570 S	4/2008	Pence et al.	
D567,098 S	4/2008	Sequeira	
D568,747 S *	5/2008	Sequeira	D9/500
D568,754 S	5/2008	Sequeira	
D569,261 S *	5/2008	Sequeira	D9/560
D573,031 S	7/2008	Hestehave	
D573,481 S *	7/2008	Chewning	D9/559
D577,593 S	9/2008	Hestehave	
D578,007 S	10/2008	Hestehave	
D578,399 S	10/2008	Hestehave	
D578,889 S	10/2008	Sadiq	
D579,338 S	10/2008	Hestehave	
D579,778 S *	11/2008	De Gopegui	D9/523
D583,236 S	12/2008	Fuchs	
D584,635 S	1/2009	Montgomery	
D588,463 S	3/2009	Forget	
D591,157 S *	4/2009	Bourne	D9/520
D594,331 S	6/2009	Herb et al.	
D594,748 S	6/2009	Herb et al.	
D596,488 S	7/2009	Chupak	
D596,942 S	7/2009	Britto	
D597,847 S *	8/2009	Floyd	D9/543
D606,401 S	12/2009	Kamath et al.	
D608,201 S	1/2010	Fluchs	
D610,017 S	2/2010	Howell	
D610,913 S	3/2010	Lesueur	

(56)

References Cited

U.S. PATENT DOCUMENTS

D611,356 S 3/2010 Kaminski et al.
 D612,247 S 3/2010 Lembke et al.
 D612,256 S 3/2010 Wurster et al.
 D612,257 S 3/2010 Wurster et al.
 D613,162 S 4/2010 Oruitt
 D613,175 S 4/2010 Oelbon
 D616,745 S 6/2010 Stull et al.
 D616,746 S 6/2010 Stull et al.
 D616,747 S 6/2010 Stull et al.
 D617,191 S 6/2010 Sutll et al.
 D617,203 S 6/2010 Yourist
 D619,014 S 7/2010 Jensen et al.
 D619,468 S 7/2010 Lembke et al.
 D623,070 S 9/2010 Jamison et al.
 D623,528 S 9/2010 Brandt
 D623,530 S 9/2010 Ungrady
 D623,531 S 9/2010 Ungrady et al.
 D624,422 S 9/2010 Caldwell et al.
 D624,823 S 10/2010 Brown
 D629,305 S 12/2010 Arnell et al.

D631,349 S 1/2011 Arnell et al.
 D640,927 S * 7/2011 Seum D9/520
 D643,291 S 8/2011 Haskins
 D655,198 S 3/2012 Finlay et al.
 D656,835 S * 4/2012 Geeraert D9/565
 D657,258 S * 4/2012 Geeraert D9/565
 D666,915 S 9/2012 Wiescinski et al.
 D667,731 S * 9/2012 Enciso D9/541
 D671,416 S 11/2012 Nukuto et al.
 D721,968 S * 2/2015 Hughes D9/516
 D721,973 S 2/2015 Das et al.
 D736,637 S * 8/2015 Castillo Higareda D9/528
 D759,495 S * 6/2016 Hawry D9/563
 D782,911 S * 4/2017 Dominick D9/542
 D791,607 S * 7/2017 Hawry D9/575
 2005/0006334 A1 1/2005 Luker

FOREIGN PATENT DOCUMENTS

GB 4005313 11/2007
 IN 256754 * 9/2013

* cited by examiner

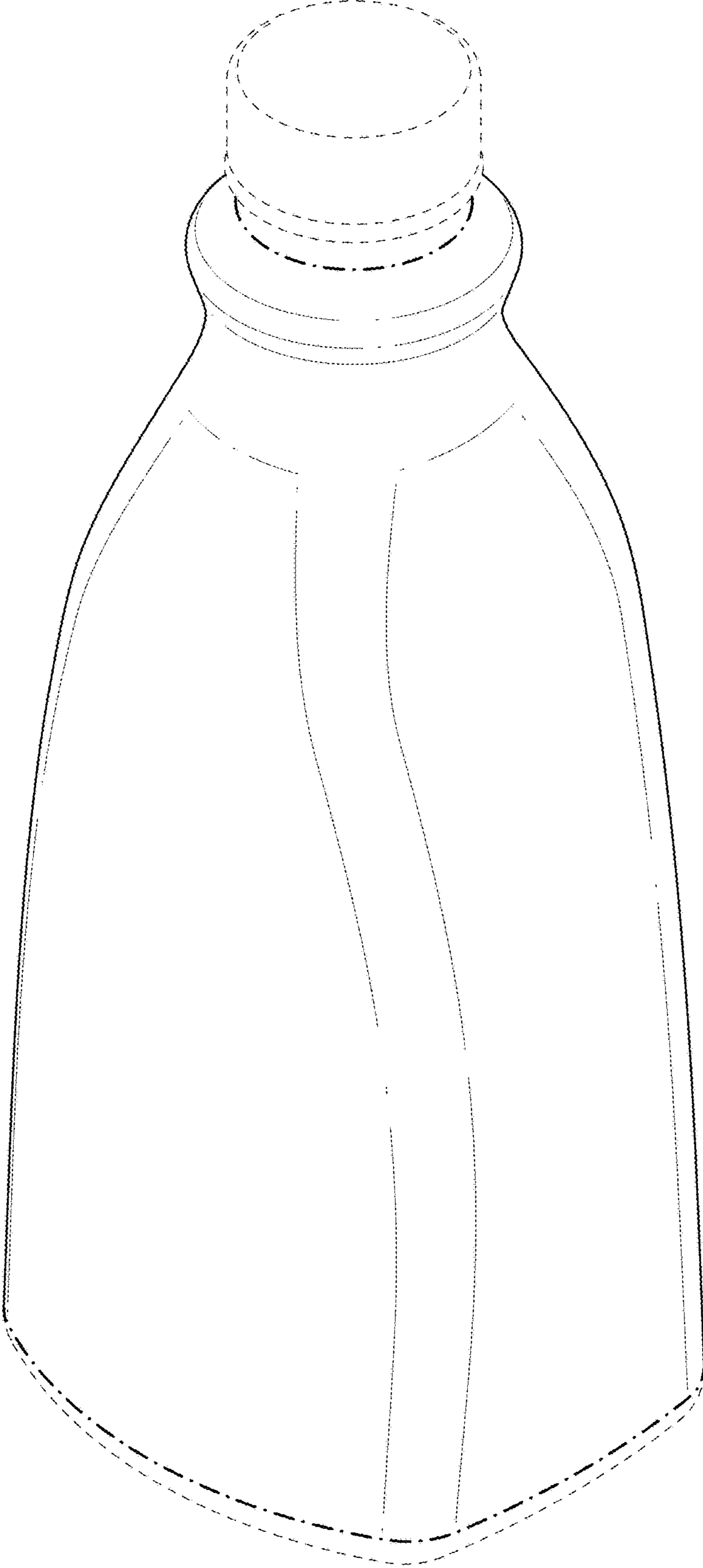

FIG. 1

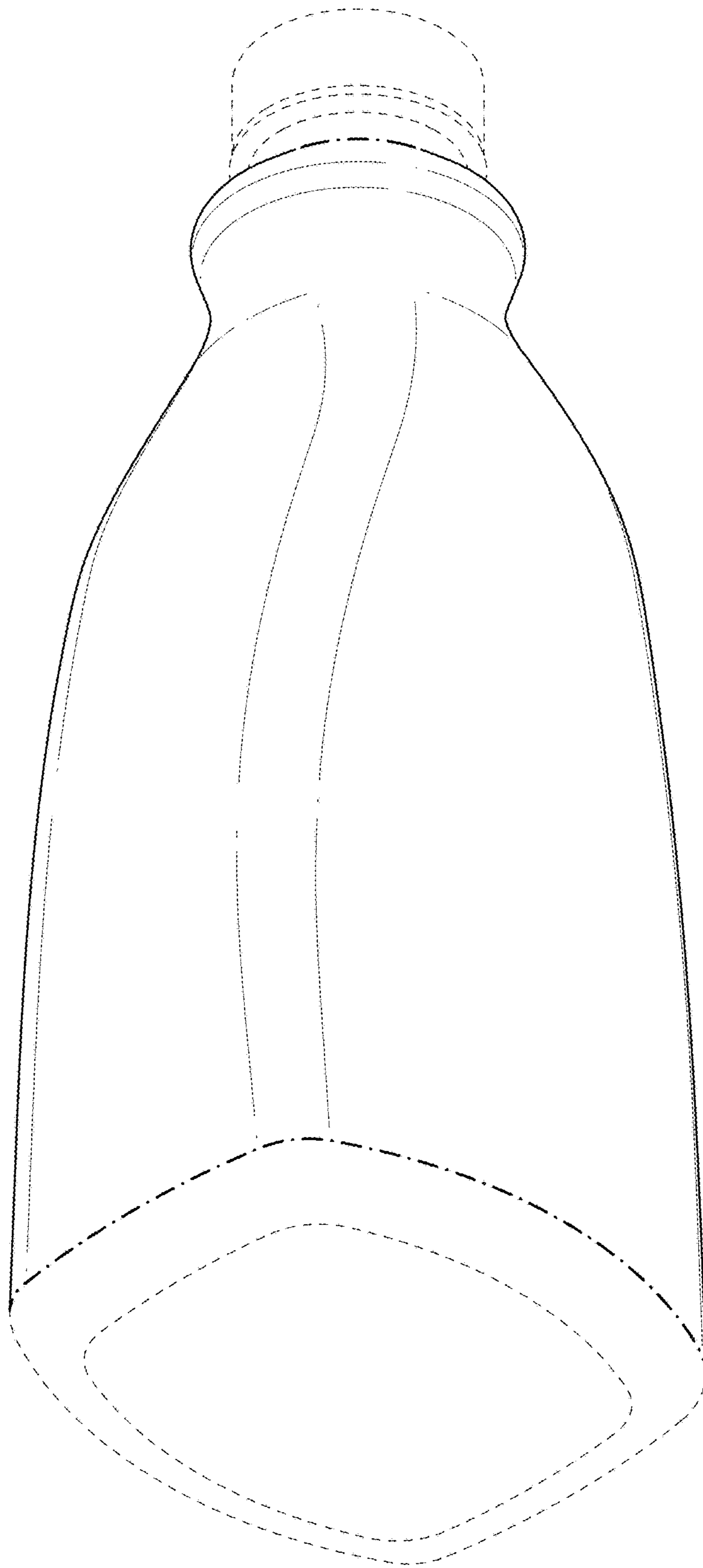

FIG. 2

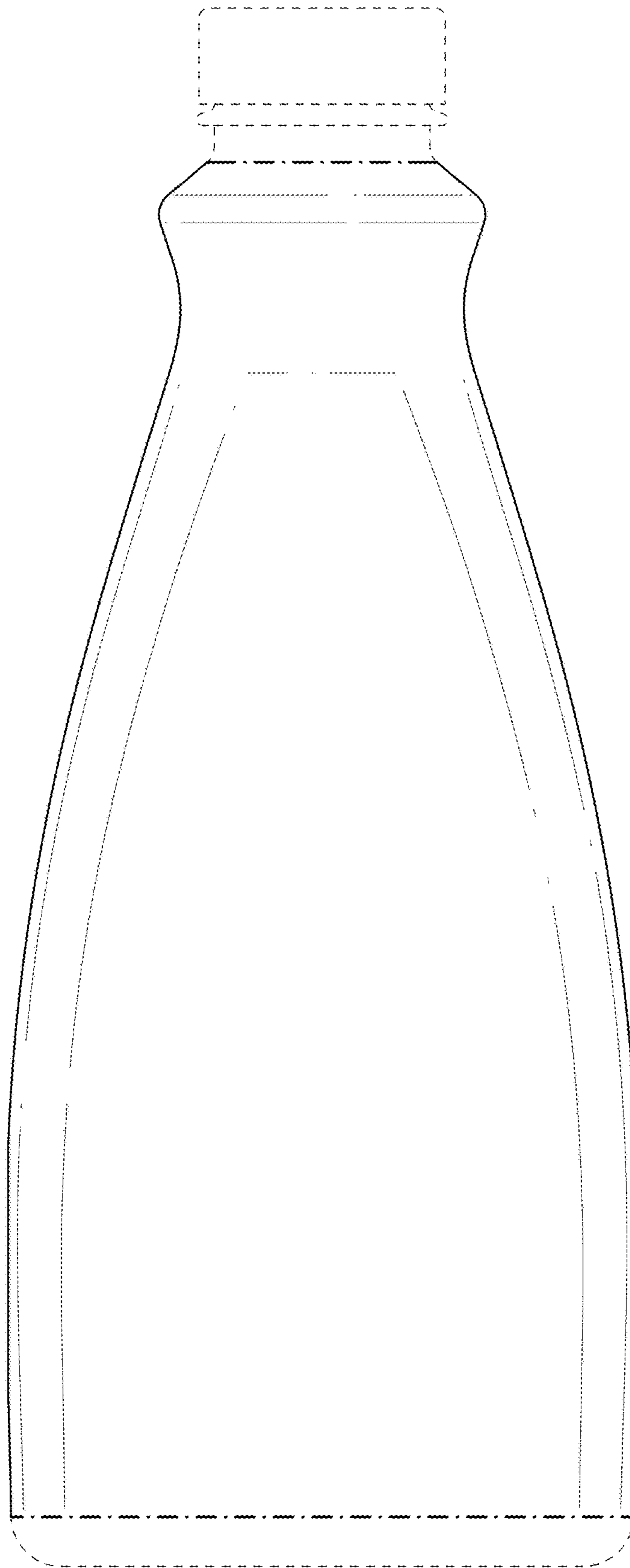

FIG. 3

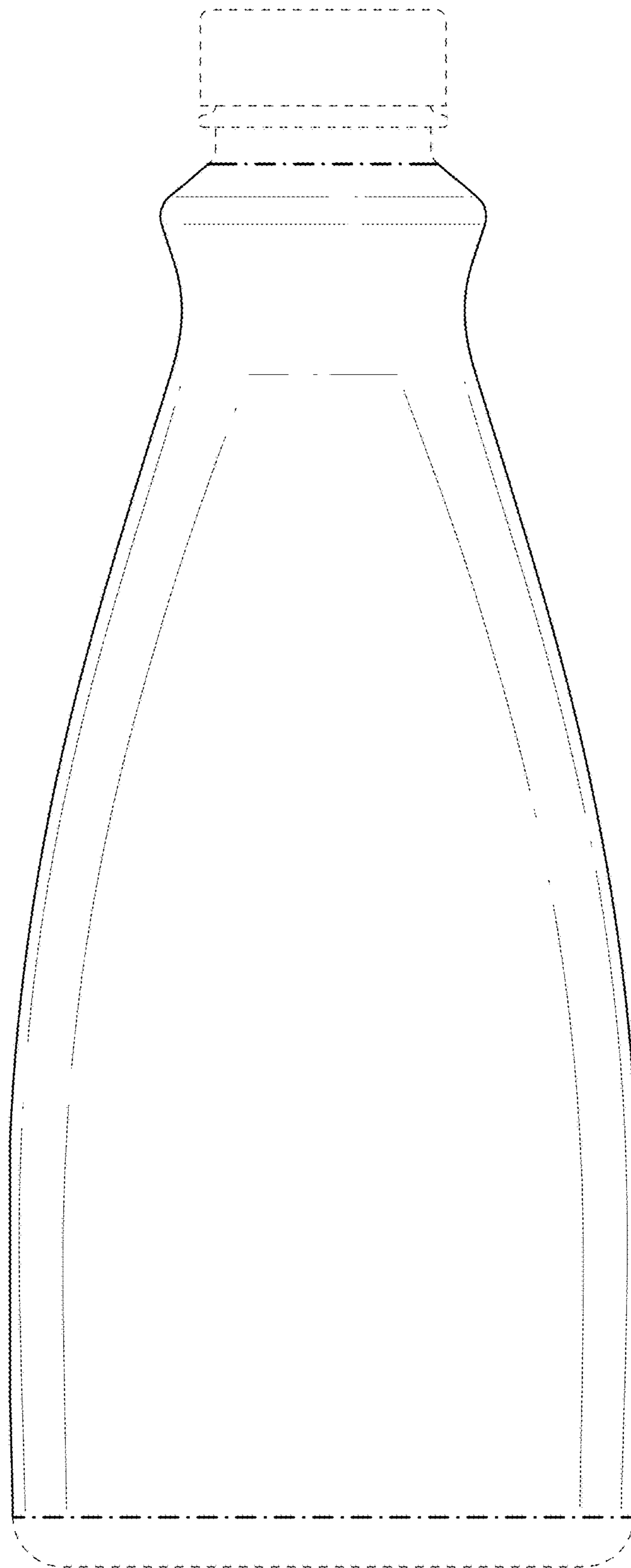

FIG. 4

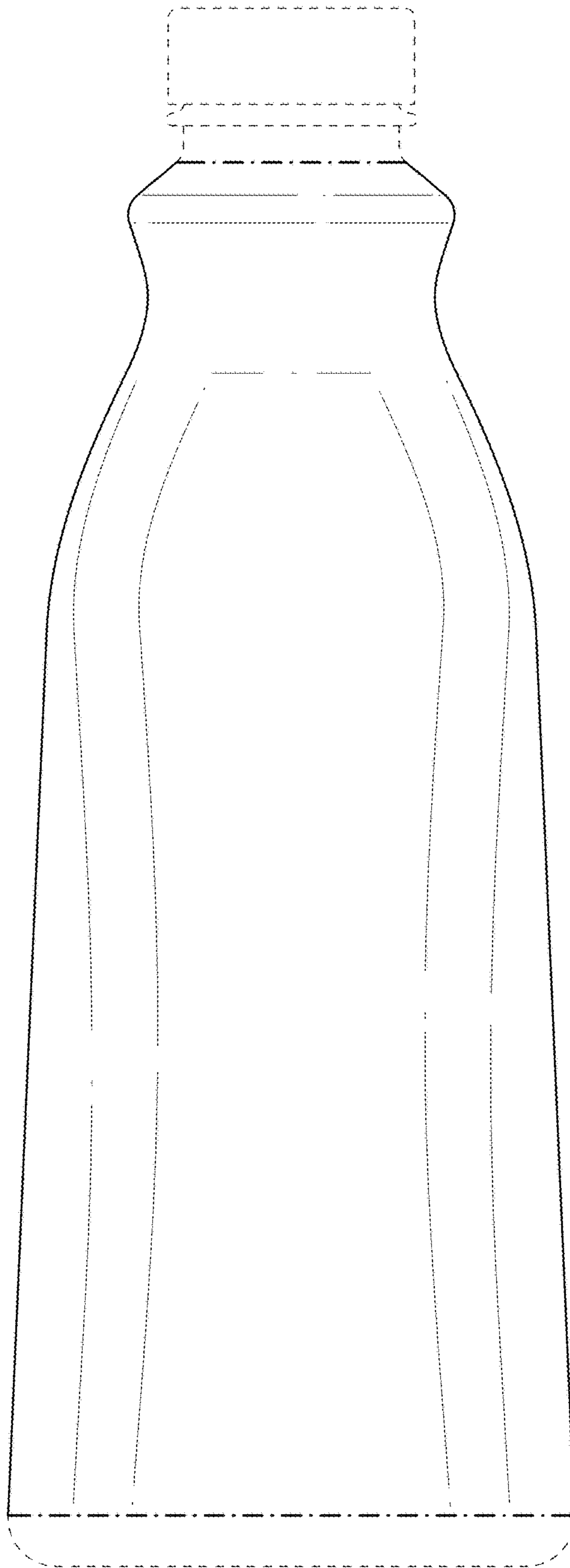

FIG. 5

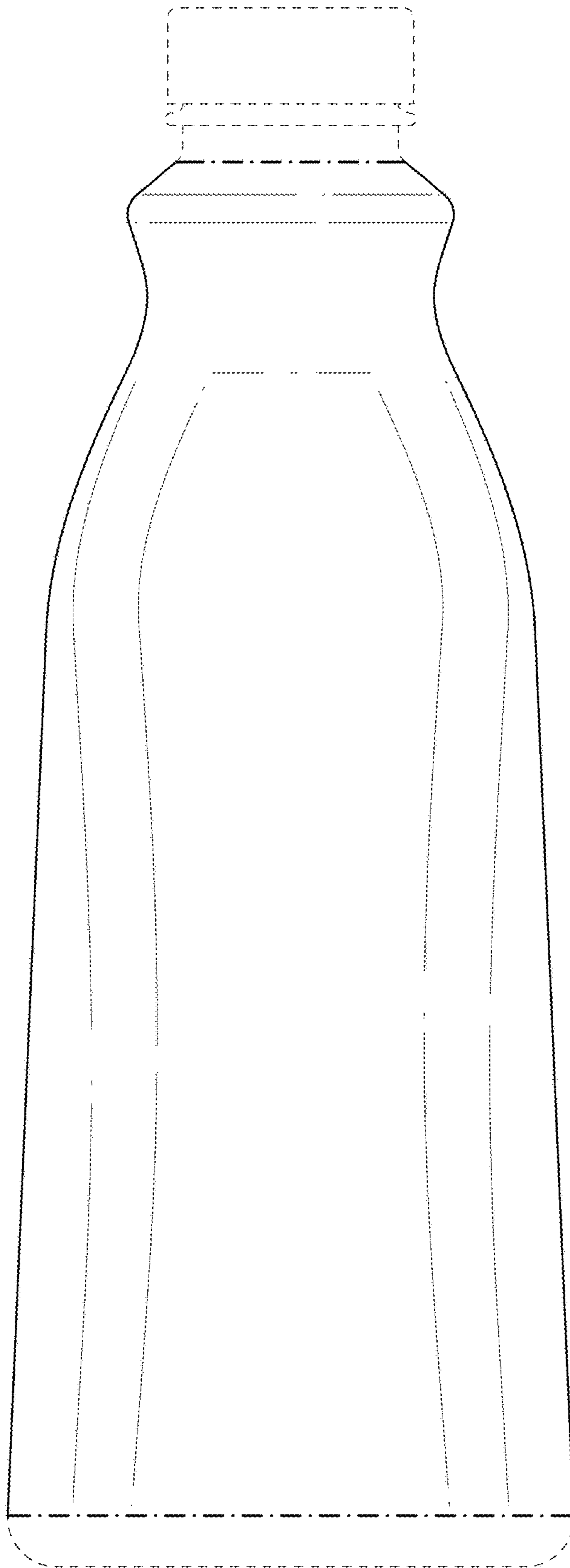

FIG. 6

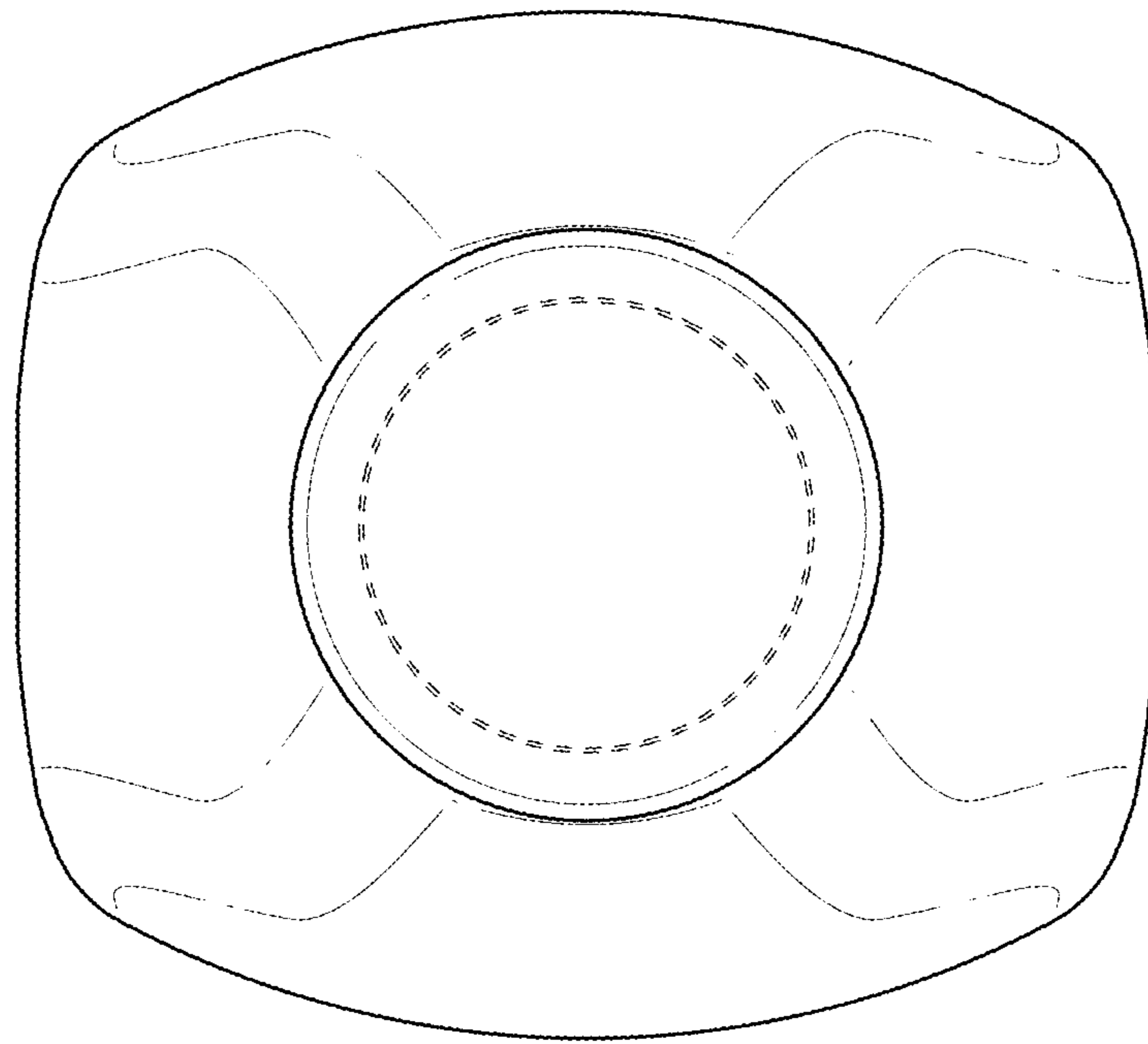

FIG. 7

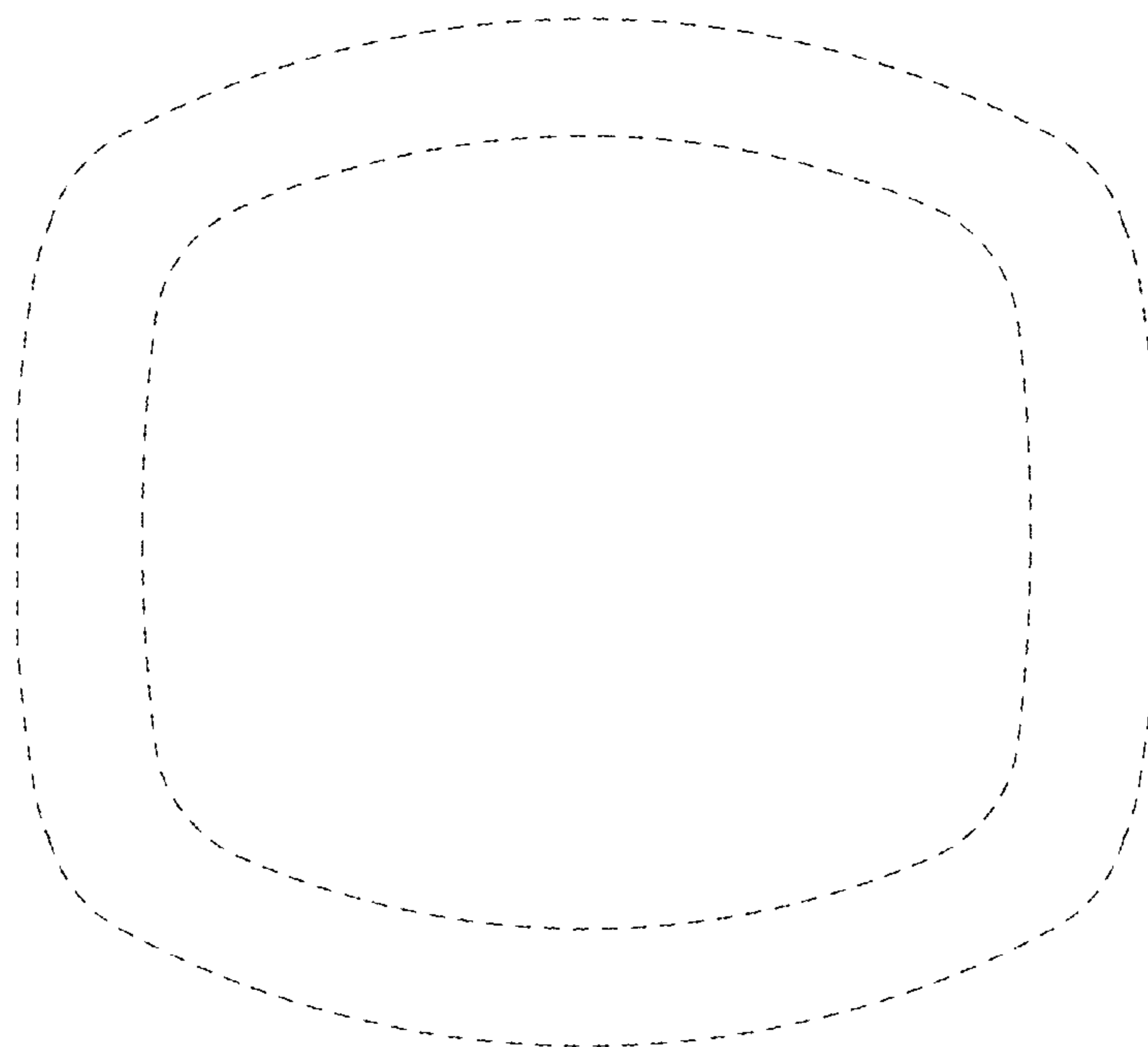

FIG. 8