



US00D804282S

(12) **United States Design Patent** (10) **Patent No.:** **US D804,282 S**
Schweiss (45) **Date of Patent:** **** Dec. 5, 2017**

(54) **PIN LATCH**
(71) Applicant: **Michael L. Schweiss**, Fairfax, MN (US)
(72) Inventor: **Michael L. Schweiss**, Fairfax, MN (US)
(73) Assignee: **SORREL QUARTERS, LLC**
(**) Term: **15 Years**
(21) Appl. No.: **29/620,269**
(22) Filed: **Sep. 12, 2016**
(51) **LOC (10) Cl.** **08-07**
(52) **U.S. Cl.**
USPC **D8/339**; D8/331
(58) **Field of Classification Search**
USPC D8/300, 302, 311, 321, 330, 331, 339, D8/249, 343, 382, DIG. 9, DIG. 10; 70/141, 142, 207, 211, 218, 224, 431, 70/465, 466, DIG. 12, DIG. 26, DIG. 31, 70/DIG. 67, DIG. 80; 292/336.3; 206/320; 220/273.1; D7/533, 642
CPC . E05B 1/00; E05B 1/0038; E05B 9/00; E05B 15/00; E05B 17/00; A47J 36/12
See application file for complete search history.

6,247,341 B1 * 6/2001 Prevot E05B 63/0069 292/DIG. 46
6,477,872 B1 * 11/2002 Denton, Jr. E05B 67/36 70/100
D498,407 S * 11/2004 Layton D8/331
(Continued)

Primary Examiner — Prabhakar Deshmukh
(74) *Attorney, Agent, or Firm* — Richard John Bartz

(57) **CLAIM**
The ornamental design of a pin latch, as shown and described.

DESCRIPTION

FIG. 1 is a perspective view of the pin latch of my design; FIG. 2 is a front elevational view thereof; FIG. 3 is a right side elevational view thereof; FIG. 4 is a left side elevational view thereof; FIG. 5 is a sectional view taken along line 5-5 of FIG. 2; FIG. 6 is a top plan view thereof; FIG. 7 is a bottom plan view thereof; FIG. 8 is a sectional view taken along line 8-8 of FIG. 2; FIG. 9 is a sectional view taken along line 9-9 of FIG. 2; FIG. 10 is a rear elevational view thereof; FIG. 11 is a perspective view of the pin latch of FIG. 1 showing the pin in its lock position; FIG. 12 is a front elevational view of FIG. 11; FIG. 13 is a right side elevational view of FIG. 11; FIG. 14 is a left side elevational view of FIG. 11; FIG. 15 is a sectional view taken along line 15-15 of FIG. 11; FIG. 16 is a top plan view of FIG. 11; FIG. 17 is a bottom plan view of FIG. 11; FIG. 18 is a sectional view taken along line 18-18 of FIG. 11; FIG. 19 is a sectional view taken along line 19-19 of FIG. 11; and, FIG. 20 is a rear elevational view of FIG. 11.

(56) **References Cited**
U.S. PATENT DOCUMENTS
3,024,838 A 3/1962 Egleston et al.
4,021,063 A * 5/1977 Porter E05C 1/04 292/148
4,026,343 A 5/1977 James
4,261,409 A 4/1981 Devore
4,765,093 A 8/1988 Edwards
5,601,131 A * 2/1997 Morris E05B 65/0021 160/207
5,868,015 A * 2/1999 Eaker E05B 67/383 292/148
6,199,617 B1 3/2001 Schweiss

1 Claim, 6 Drawing Sheets

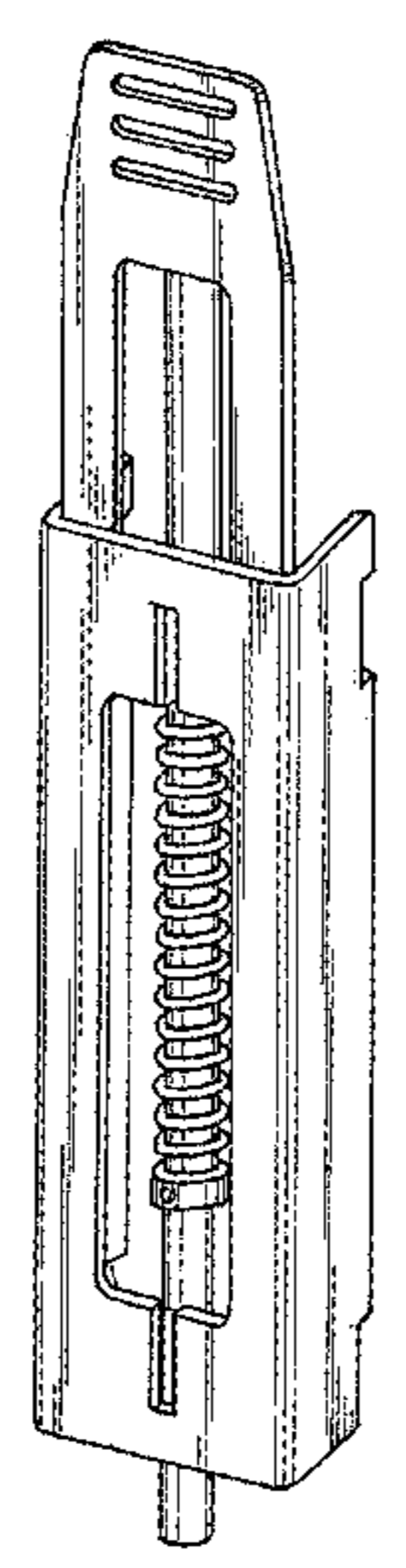

(56)

References Cited

U.S. PATENT DOCUMENTS

6,866,080	B2	3/2005	Schweiss	
D524,633	S *	7/2006	Robert	D8/339
7,219,711	B2	5/2007	Keller et al.	
8,297,175	B1 *	10/2012	Davies	F41A 3/94 42/1.06
8,602,225	B2 *	12/2013	Lin	A47B 88/43 211/26
D710,183	S *	8/2014	Huddleston	D8/339
D769,101	S *	10/2016	Zemel	D8/321

* cited by examiner

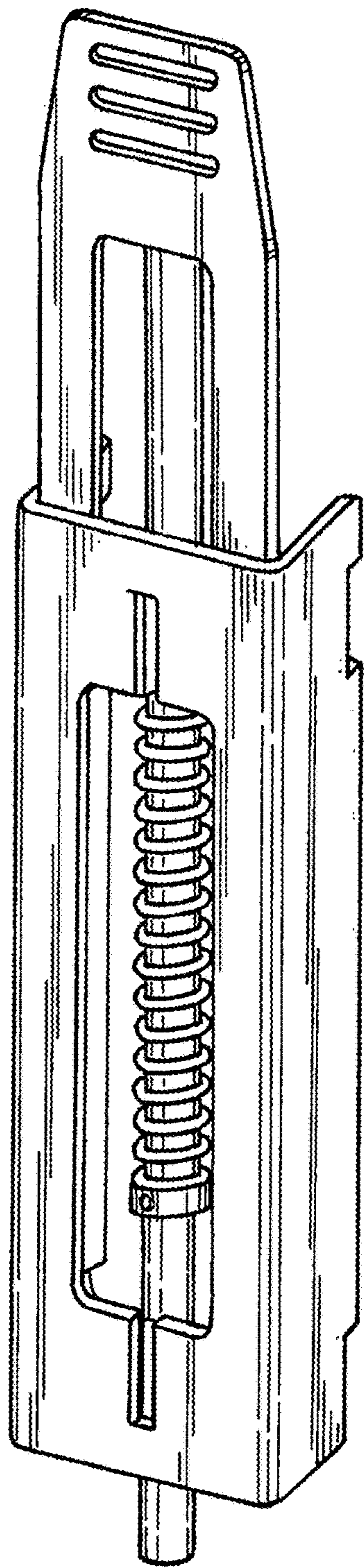

FIG.1

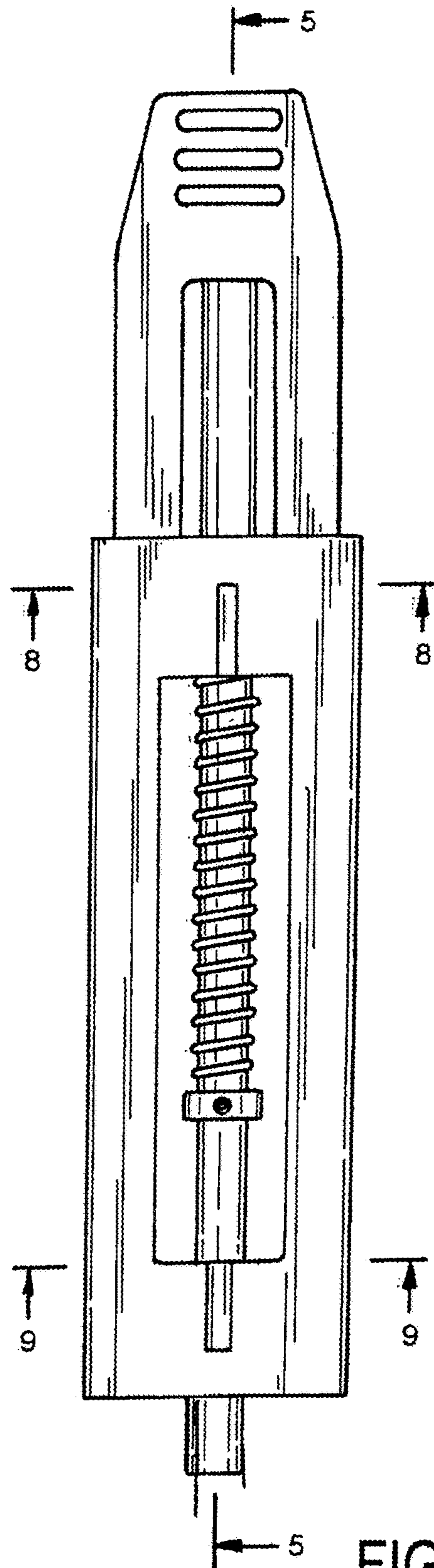

FIG.2

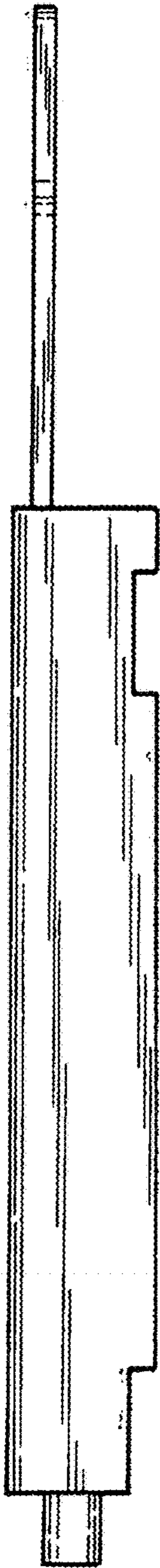

FIG. 3

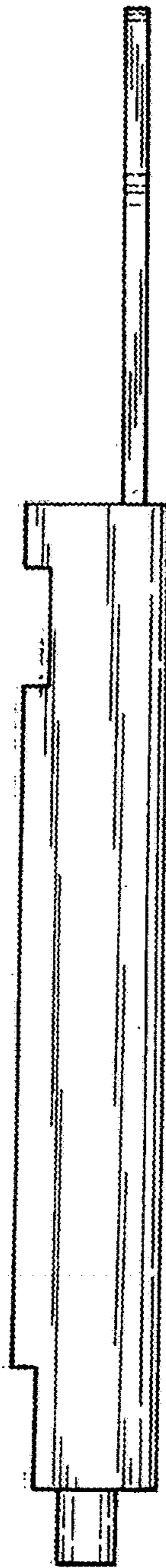

FIG. 4

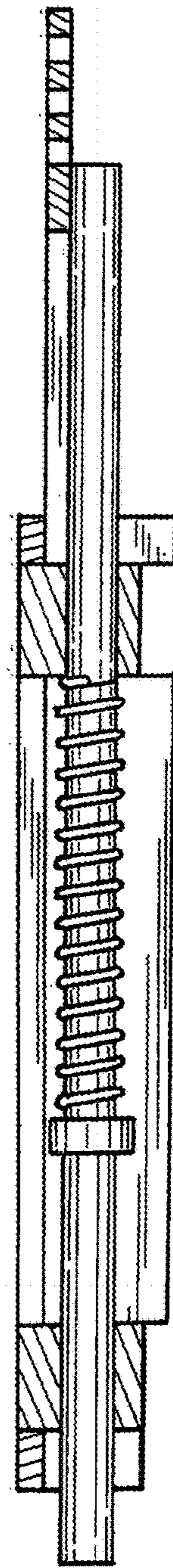

FIG. 5

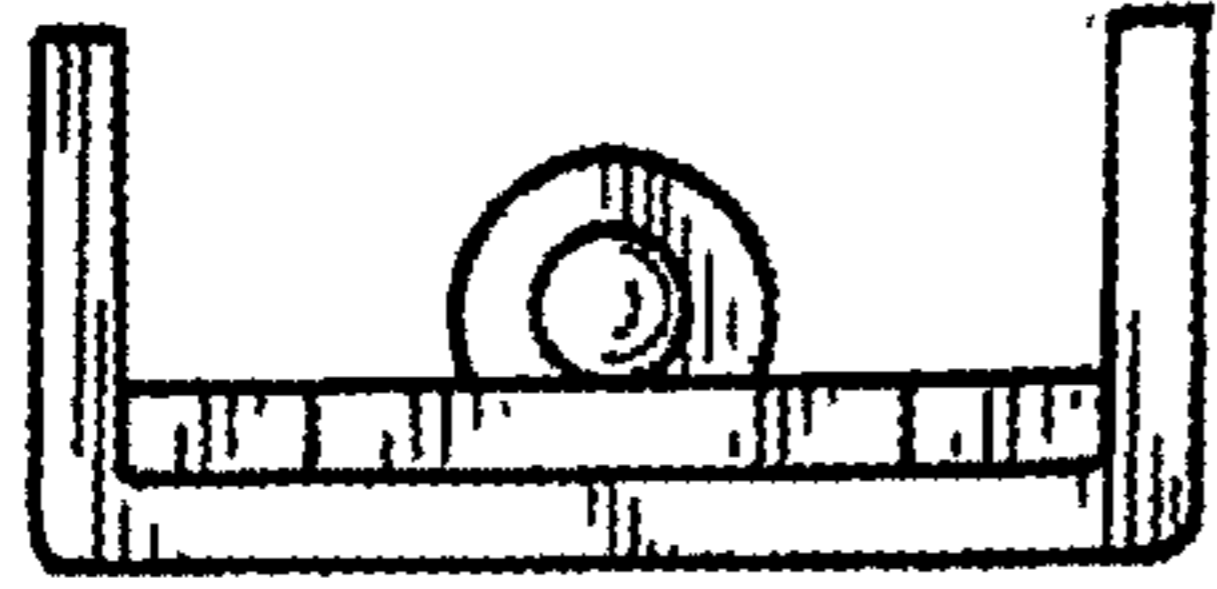

FIG. 6

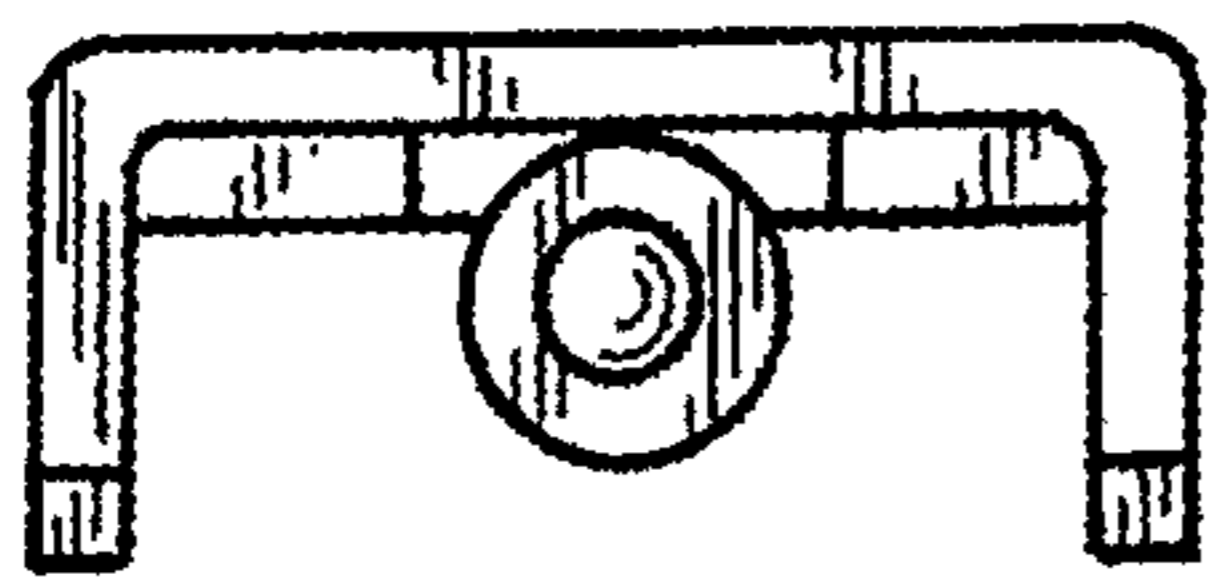

FIG. 7

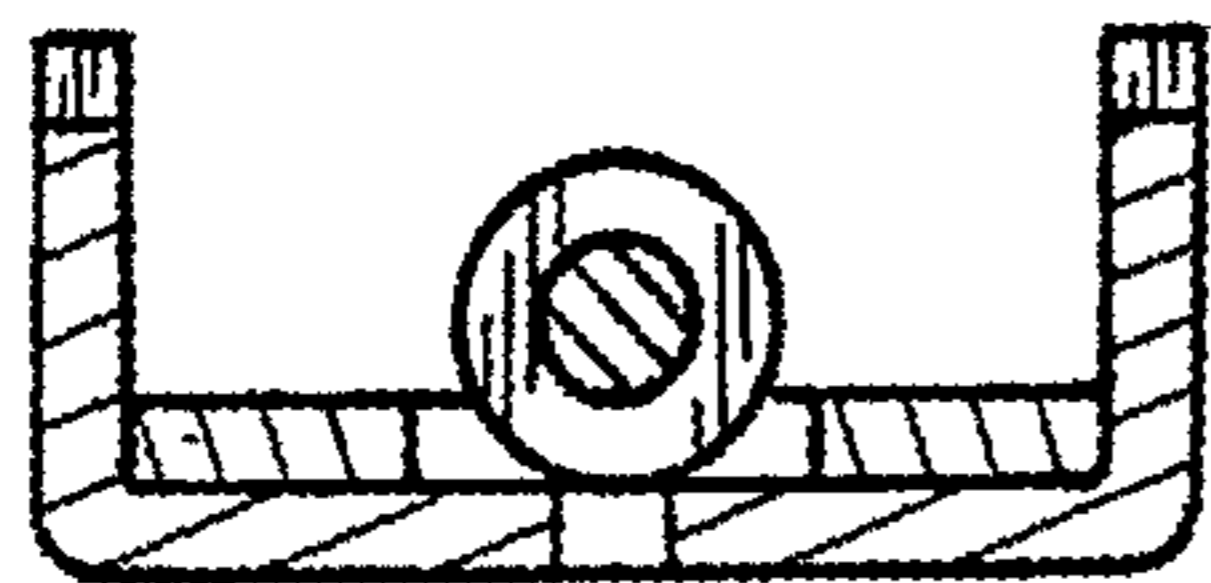

FIG. 8

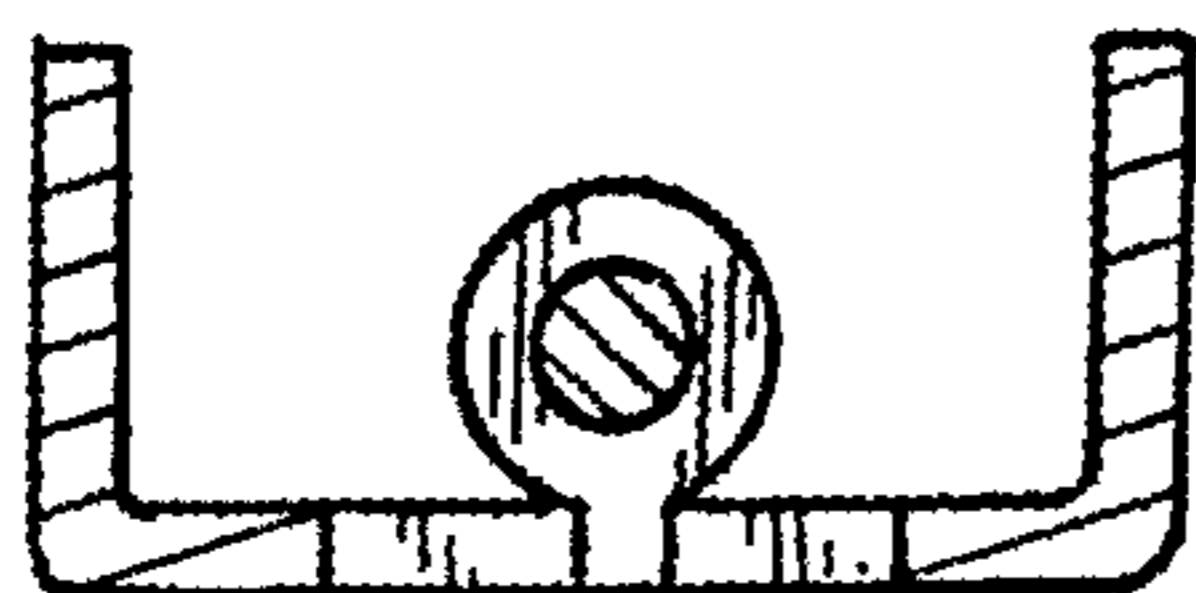

FIG. 9

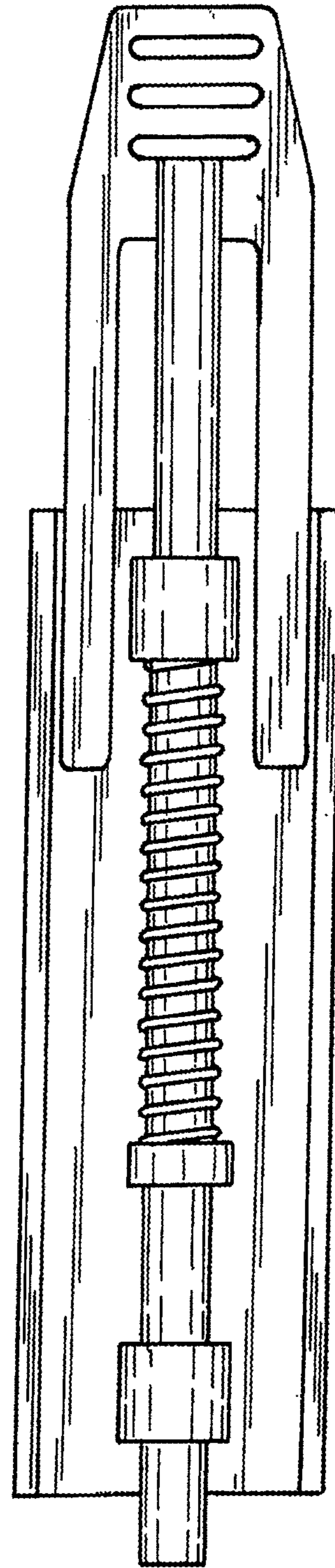

FIG. 10

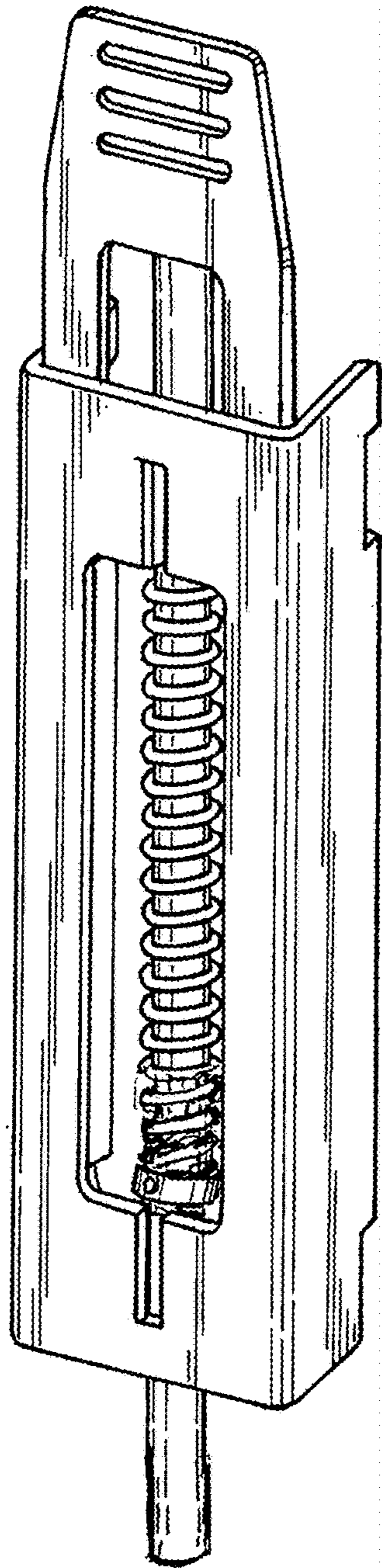

FIG. 11

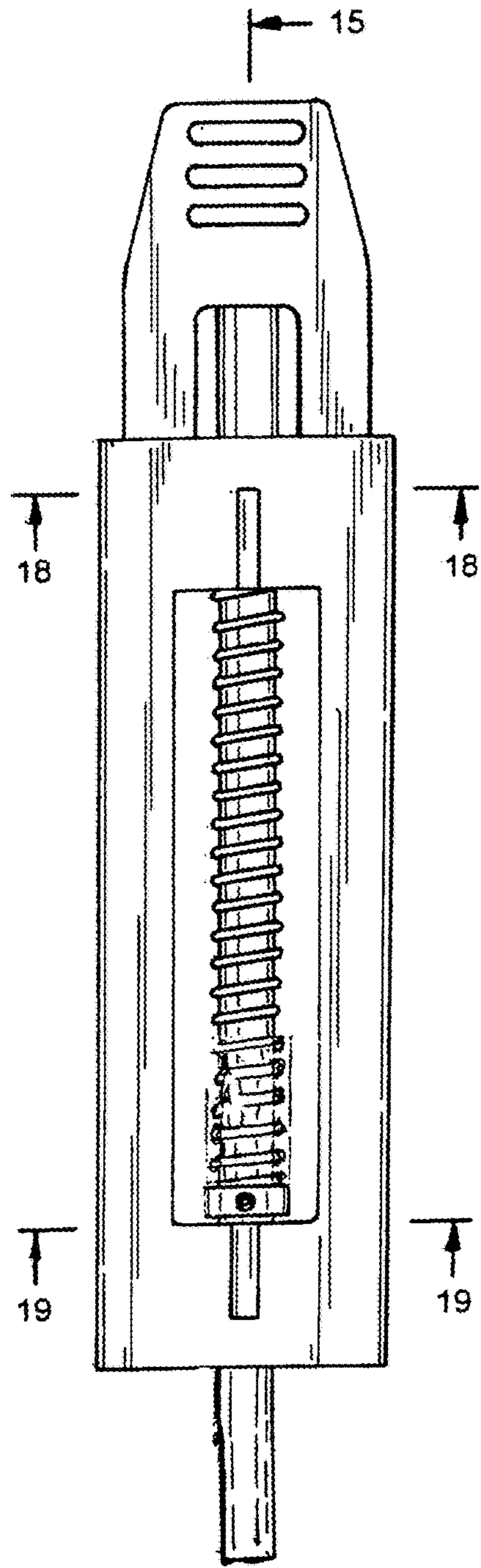

FIG. 12

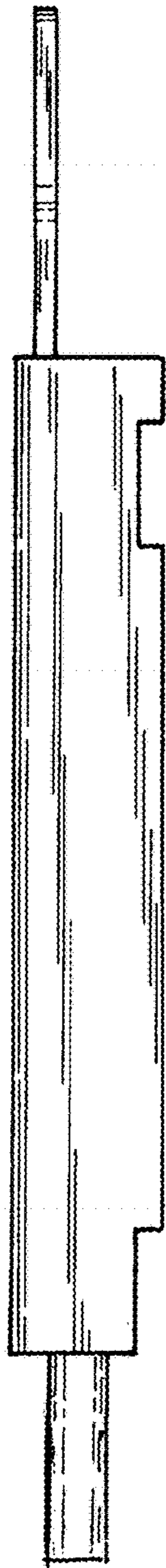

FIG. 13

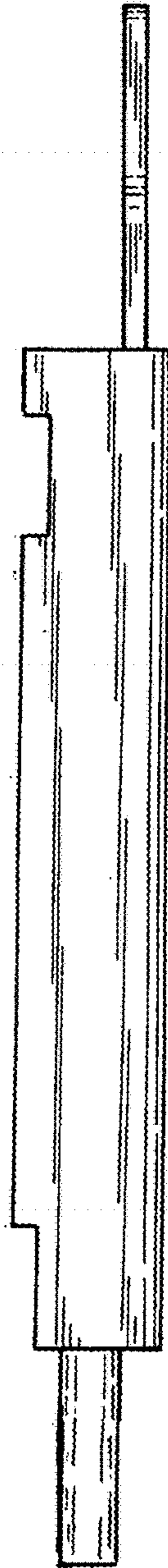

FIG. 14

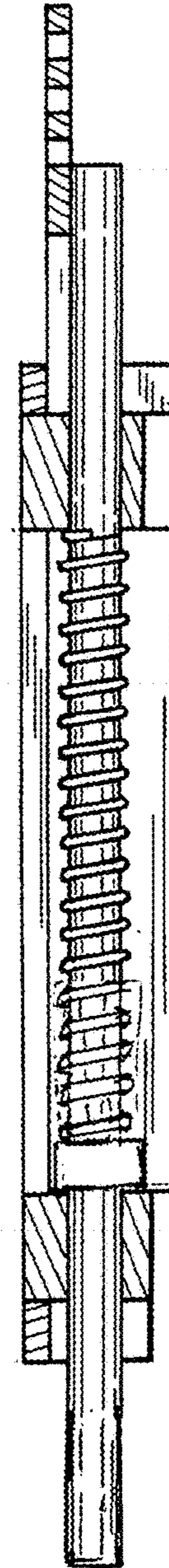

FIG. 15

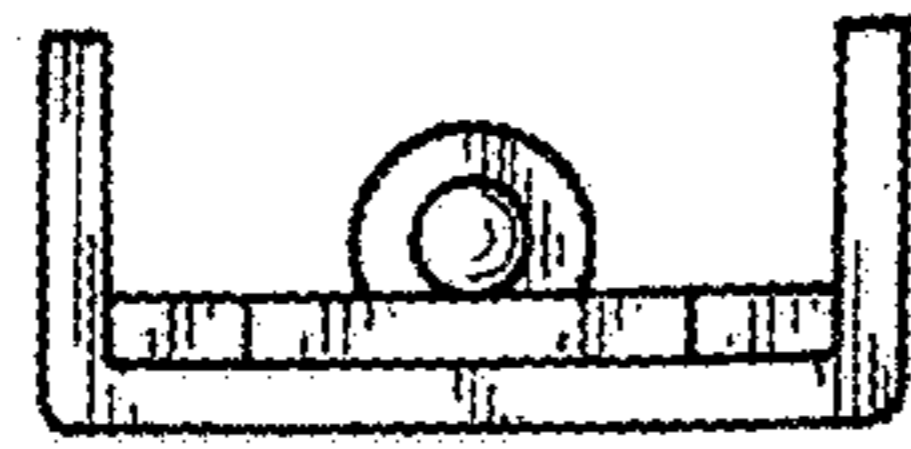

FIG. 16

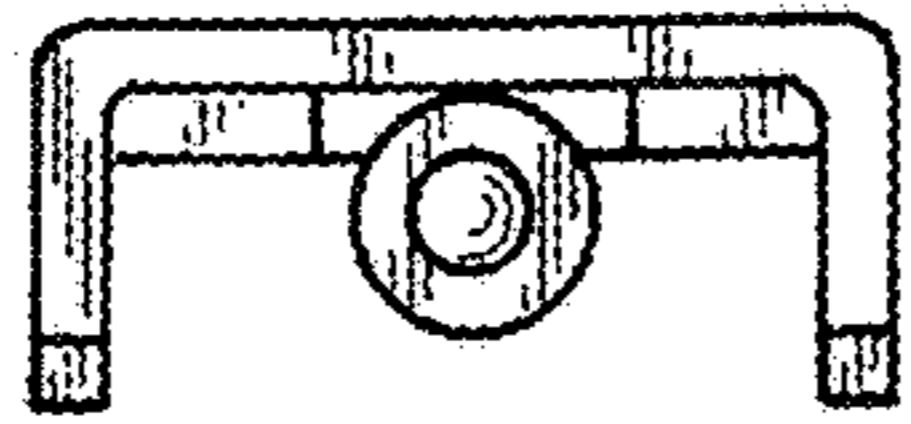

FIG. 17

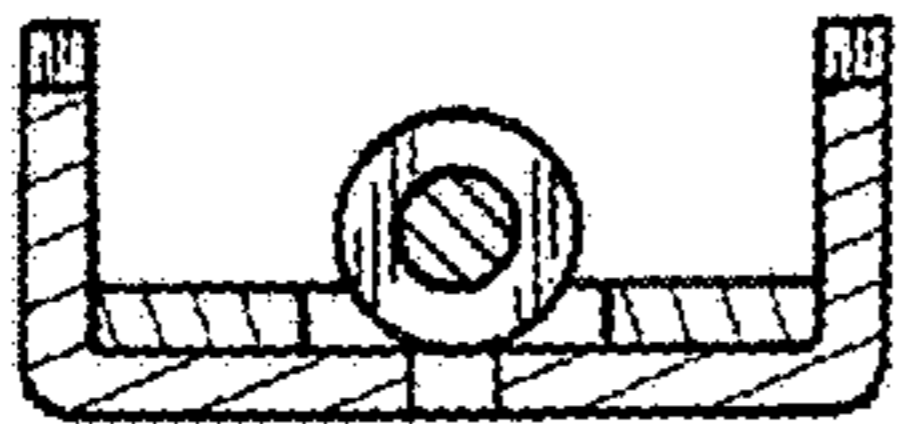

FIG. 18

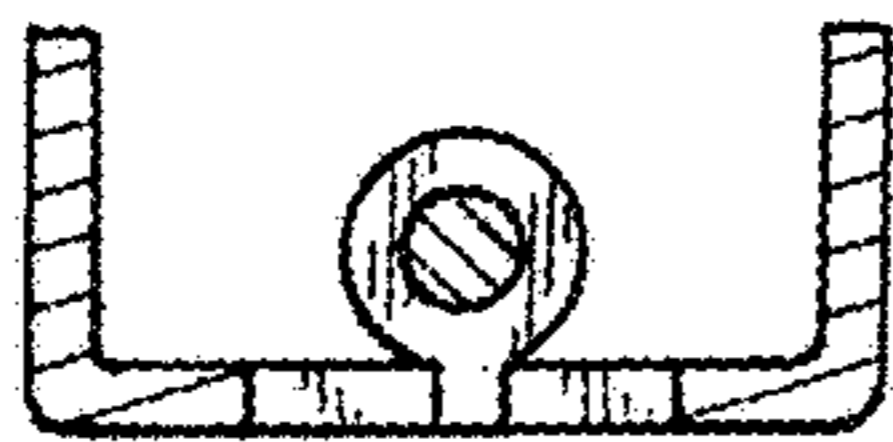

FIG. 19

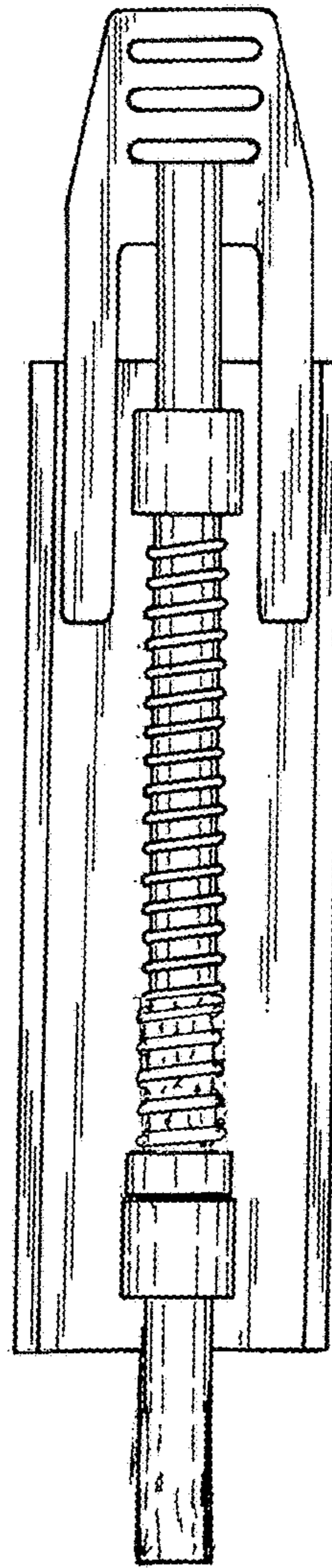

FIG. 20