



US00D804207S

(12) **United States Design Patent** (10) **Patent No.:** **US D804,207 S**
Blomme (45) **Date of Patent:** **** Dec. 5, 2017**

(54) **VEHICLE SEAT**

(71) Applicant: **Volvo Car Corporation**, Gothenburg (SE)

(72) Inventor: **Conny Blomme**, Ljungkile (SE)

(73) Assignee: **Volvo Car Corporation**, Gothenburg (SE)

(**) Term: **15 Years**

(21) Appl. No.: **29/583,131**

(22) Filed: **Nov. 2, 2016**

(51) **LOC (10) Cl.** **06-01**

(52) **U.S. Cl.**
USPC **D6/356**

(58) **Field of Classification Search**
USPC D6/334-336, 356, 367, 368, 374, 375,
D6/716, 716.1, 716.2, 716.3, 716.4, 716.5
CPC B60N 2/3081; B60N 2/3084; B60N 2/00;
B60N 2/48; B60N 2/22; B60N 2/449;
B60N 2/4882; A47C 7/022; A47C 7/18
See application file for complete search history.

(56) **References Cited**

U.S. PATENT DOCUMENTS

5,280,995 A * 1/1994 Elton B60N 2/3084
297/238
5,704,685 A * 1/1998 Handa B60N 2/3084
297/452.34
D542,041 S * 5/2007 Moburg D6/356
D576,811 S * 9/2008 Wyszogrod D6/356
D578,315 S * 10/2008 Wyszogrod D6/356

D590,612 S * 4/2009 Zhang D6/356
D650,188 S * 12/2011 Nakaminami D6/356
D650,189 S * 12/2011 Nakaminami D6/356
D723,825 S * 3/2015 Persson D6/356
D755,531 S * 5/2016 Ahn D6/356
D767,292 S * 9/2016 Line D6/356
D774,319 S * 12/2016 Ingenlath D6/356
D778,080 S * 2/2017 Ahn D6/356

* cited by examiner

Primary Examiner — Mimoso De

(74) *Attorney, Agent, or Firm* — Snyder, Clark, Lesch & Chung, LLP

(57) **CLAIM**

The ornamental design of a vehicle seat, as shown in the figures and described.

DESCRIPTION

FIG. 1 is a front view of a vehicle seat illustrating the design of the present invention;
FIG. 2 is a front perspective view of the vehicle seat of FIG. 1;
FIG. 3 is a right-side view of the vehicle seat of FIG. 1;
FIG. 4 is a rear view of the vehicle seat of FIG. 1;
FIG. 5 is a rear perspective view of the vehicle seat of FIG. 1;
FIG. 6 is a left-side view of the vehicle seat of FIG. 1;
FIG. 7 is a top view of the vehicle seat of FIG. 1; and,
FIG. 8 is a bottom view of the vehicle seat of FIG. 1.
Structure that is not part of the claimed design is represented in the figures by broken lines.

1 Claim, 8 Drawing Sheets



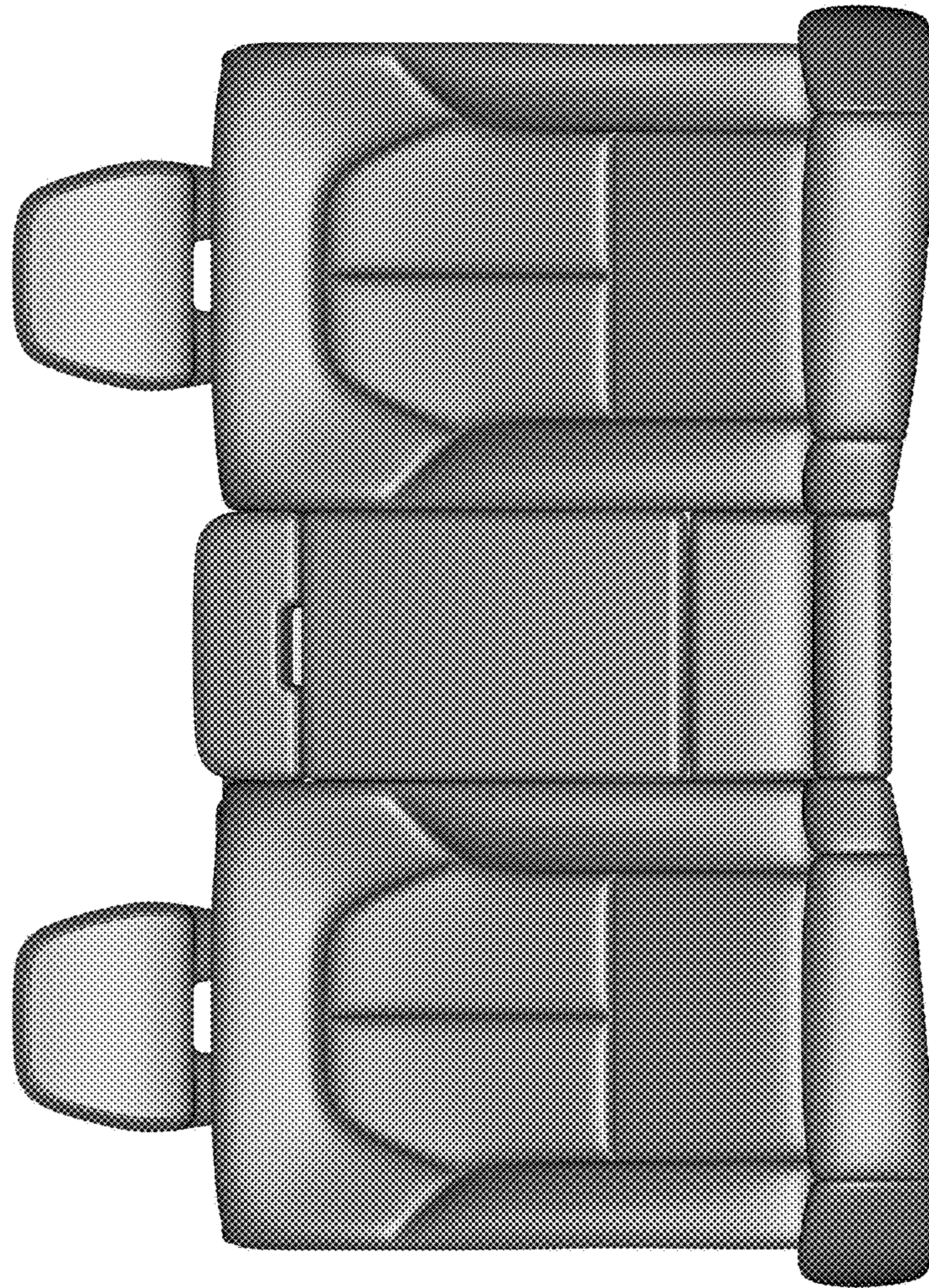

FIG. 1

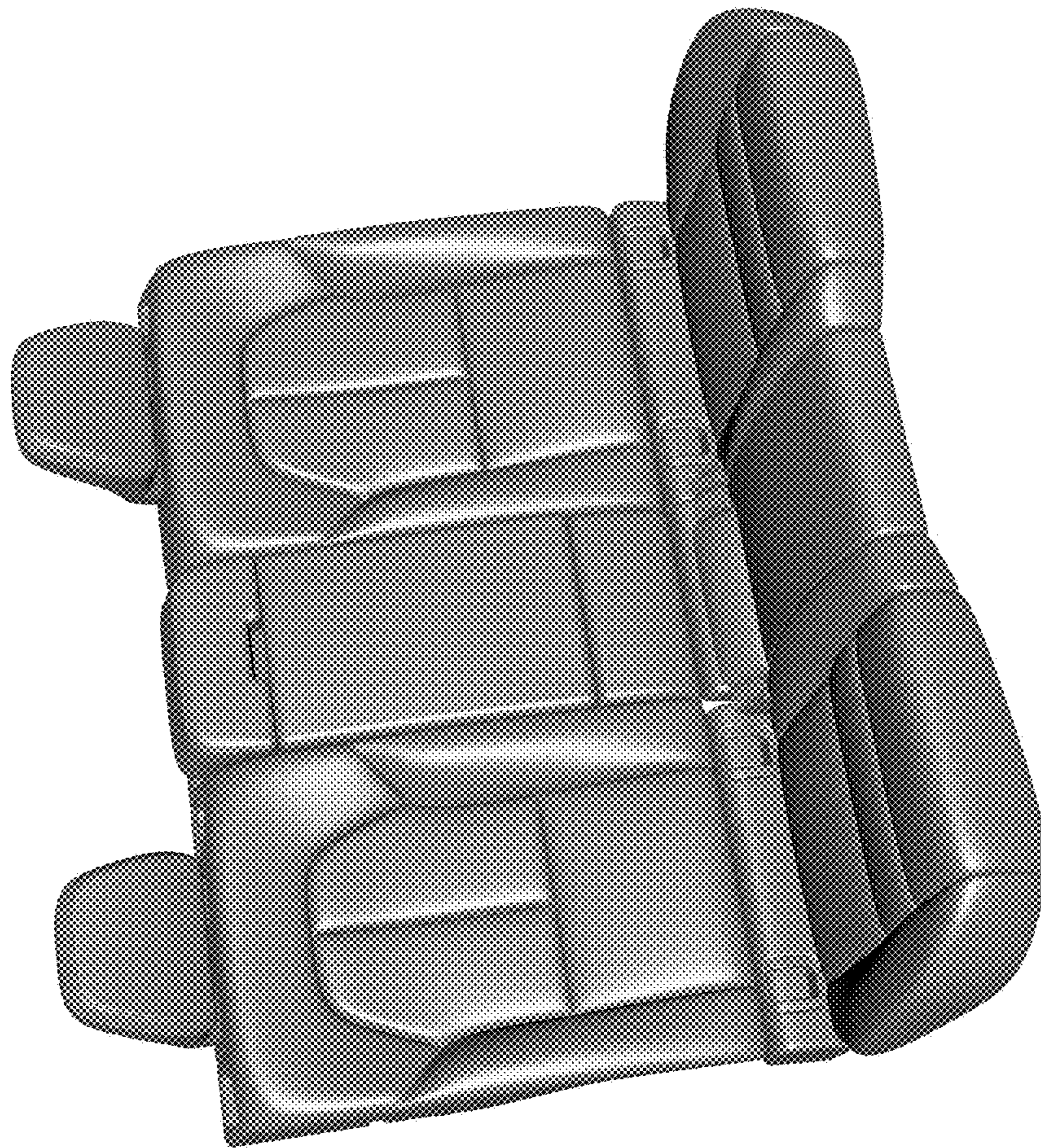

FIG. 2

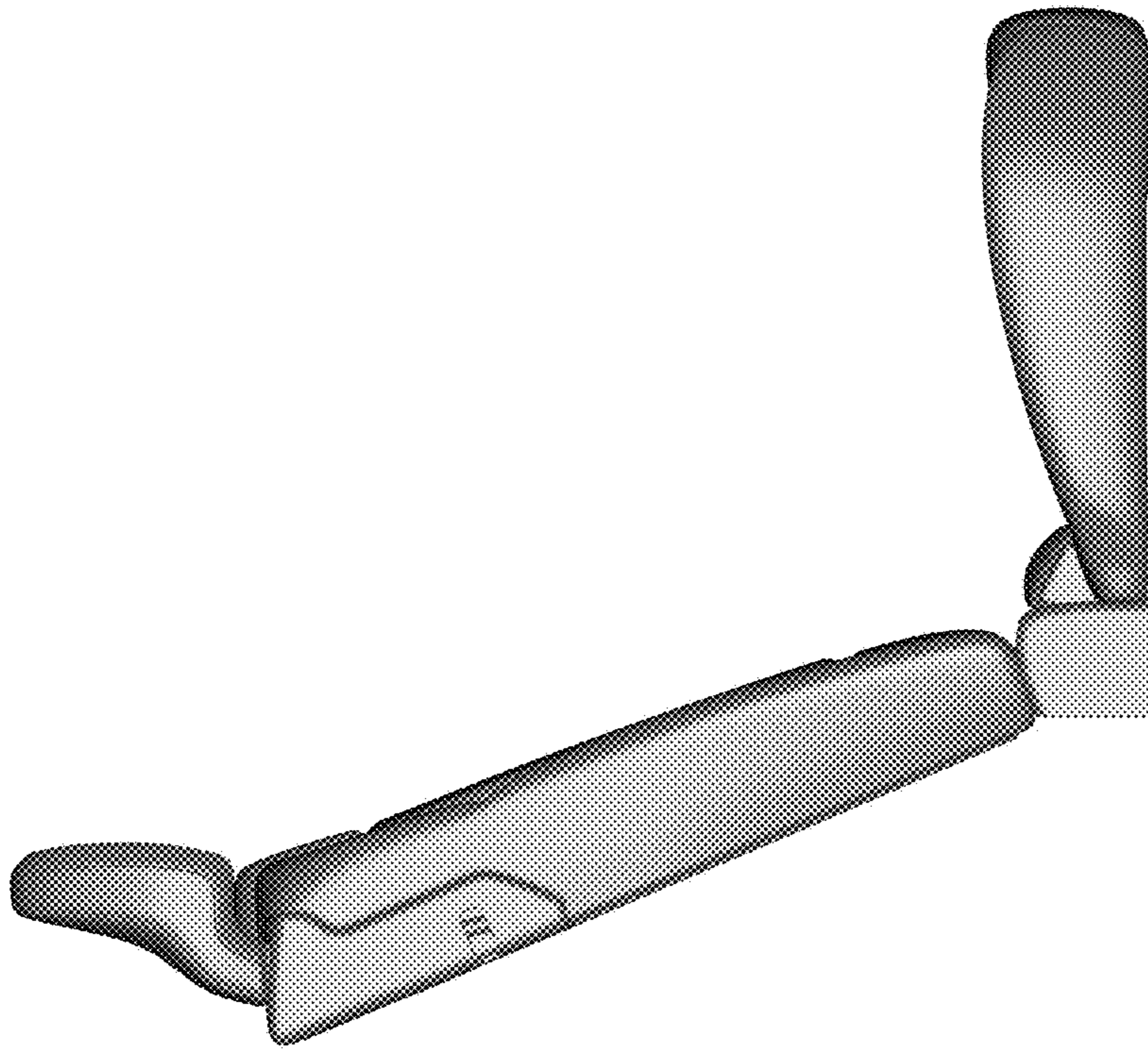

FIG. 3

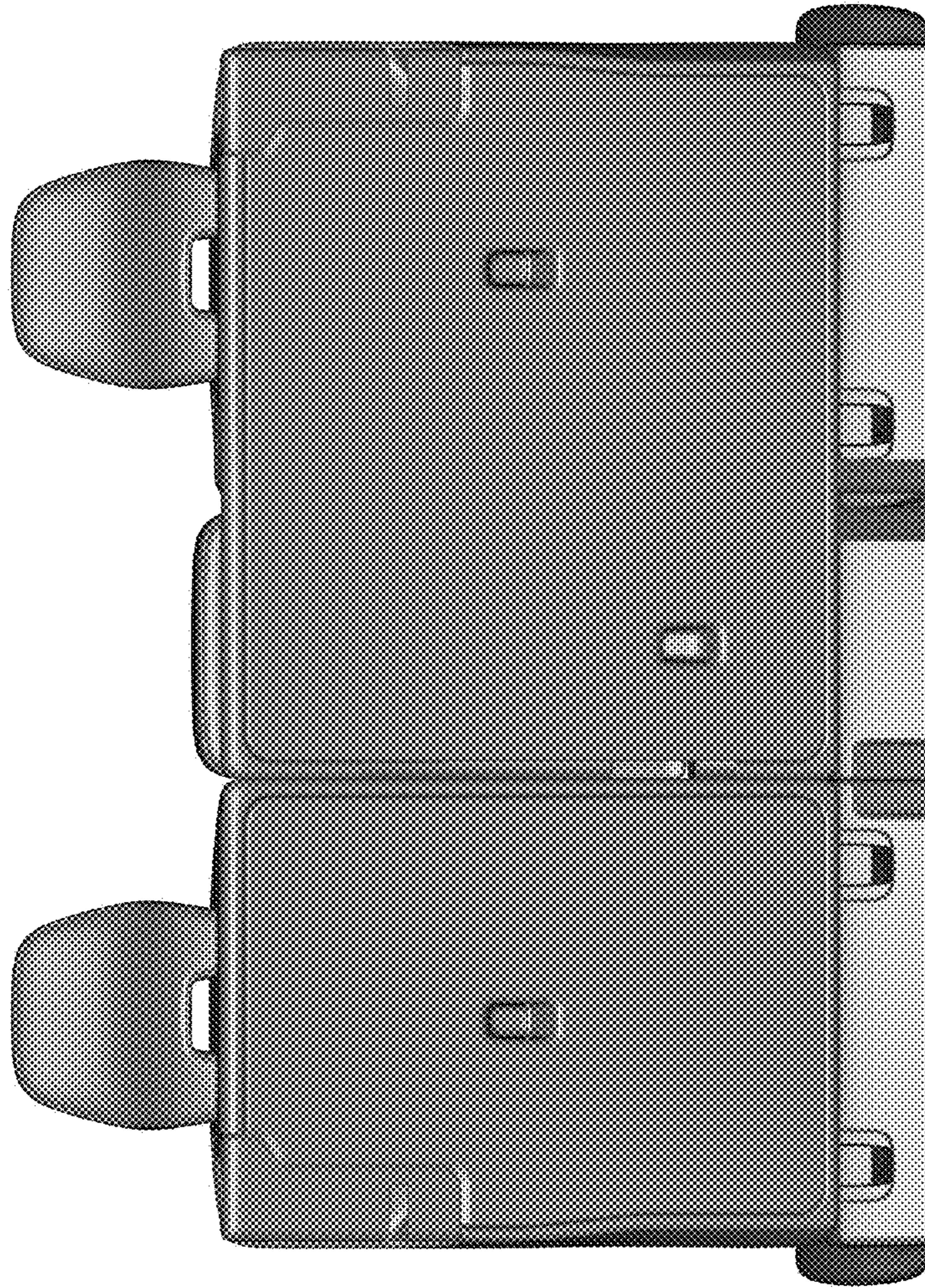

FIG. 4

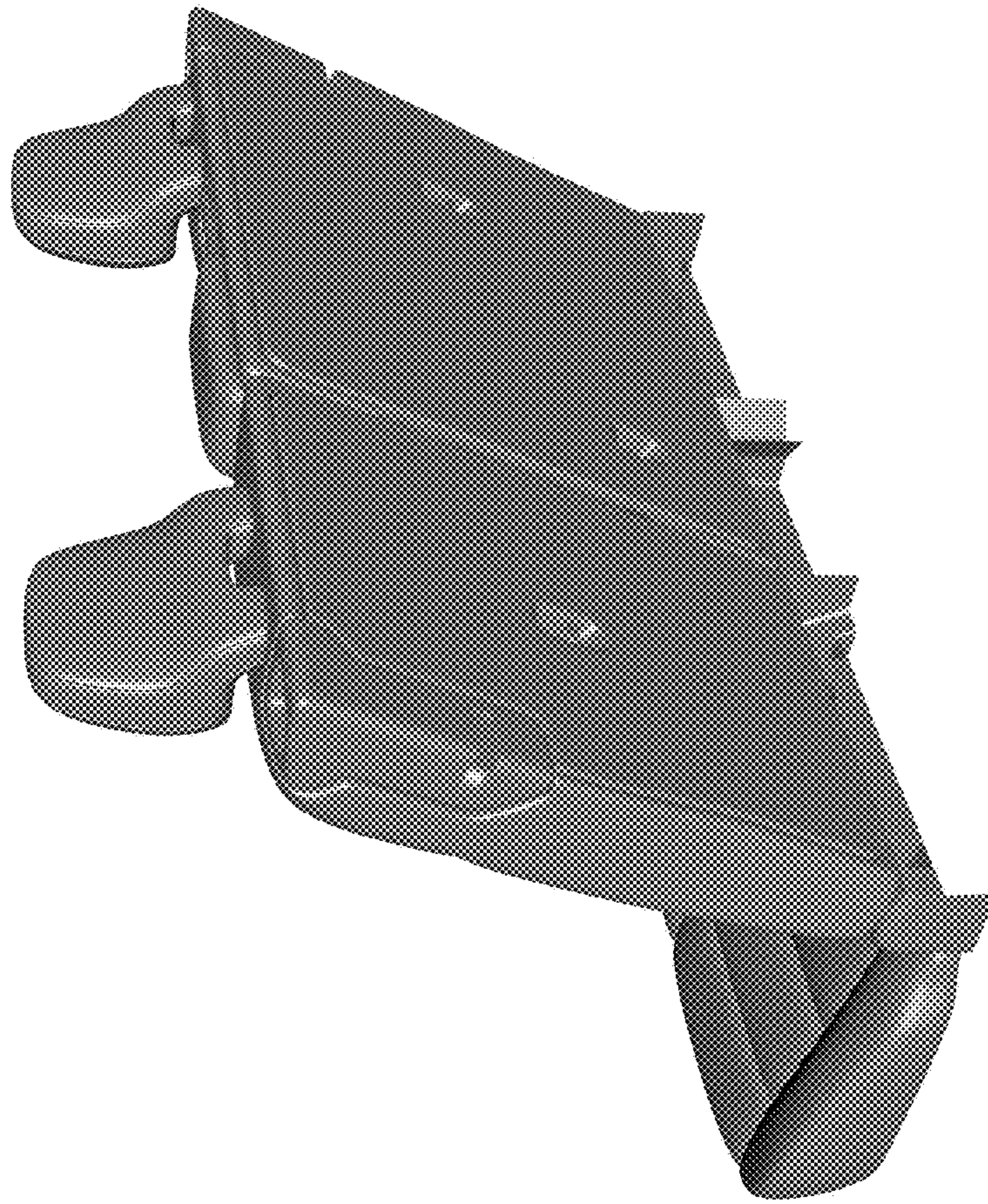

FIG. 5

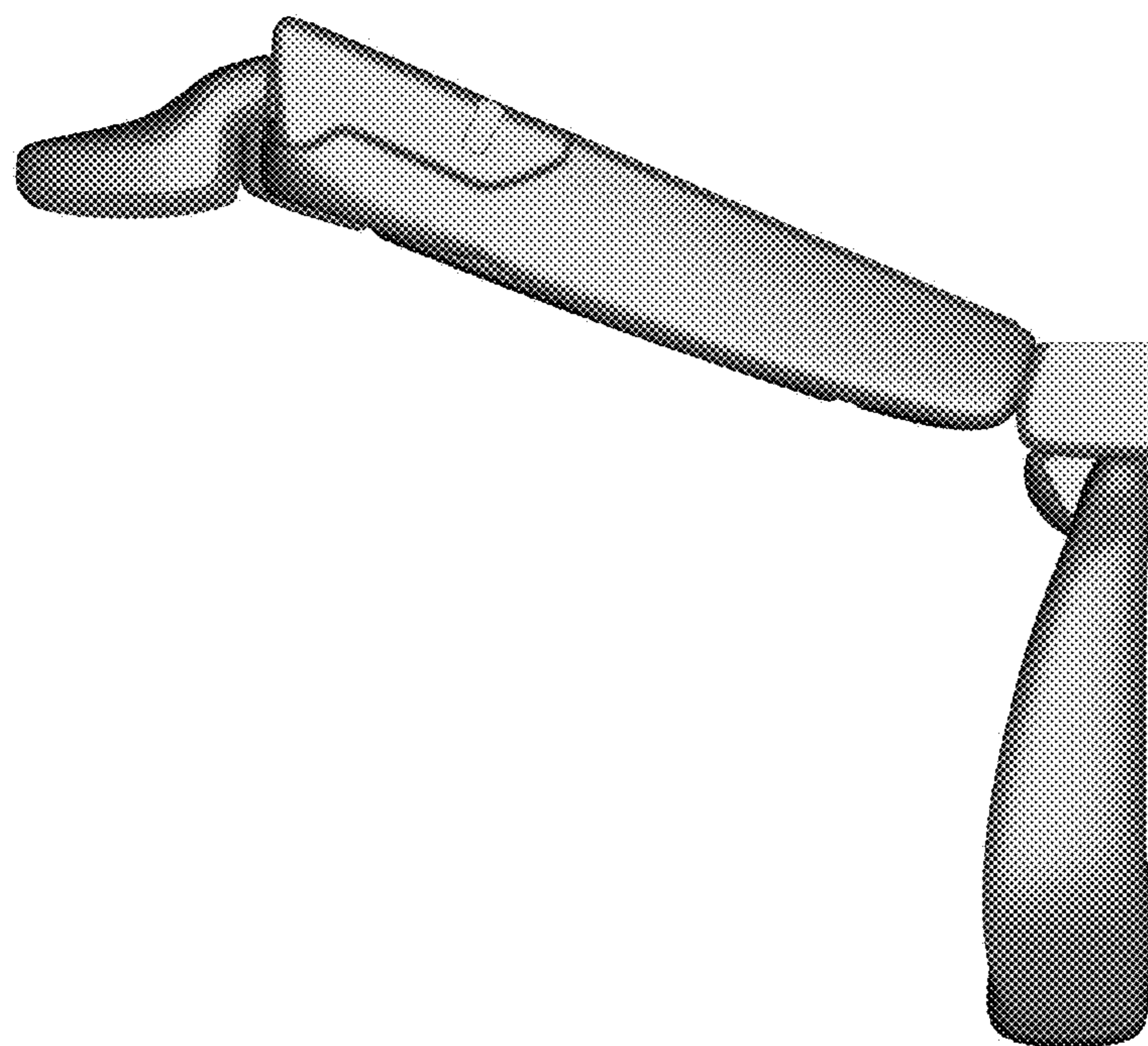

FIG. 6

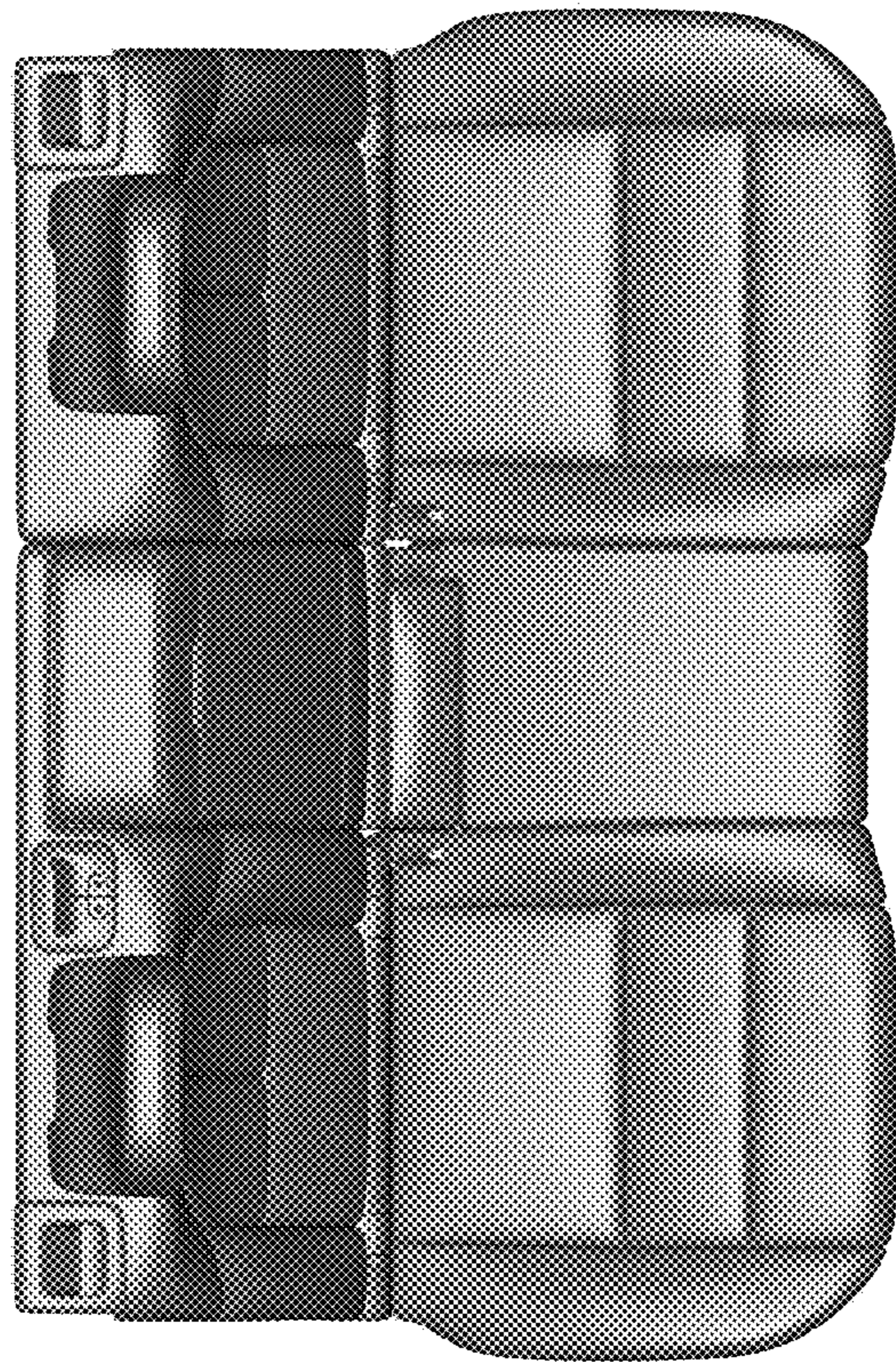

FIG. 7

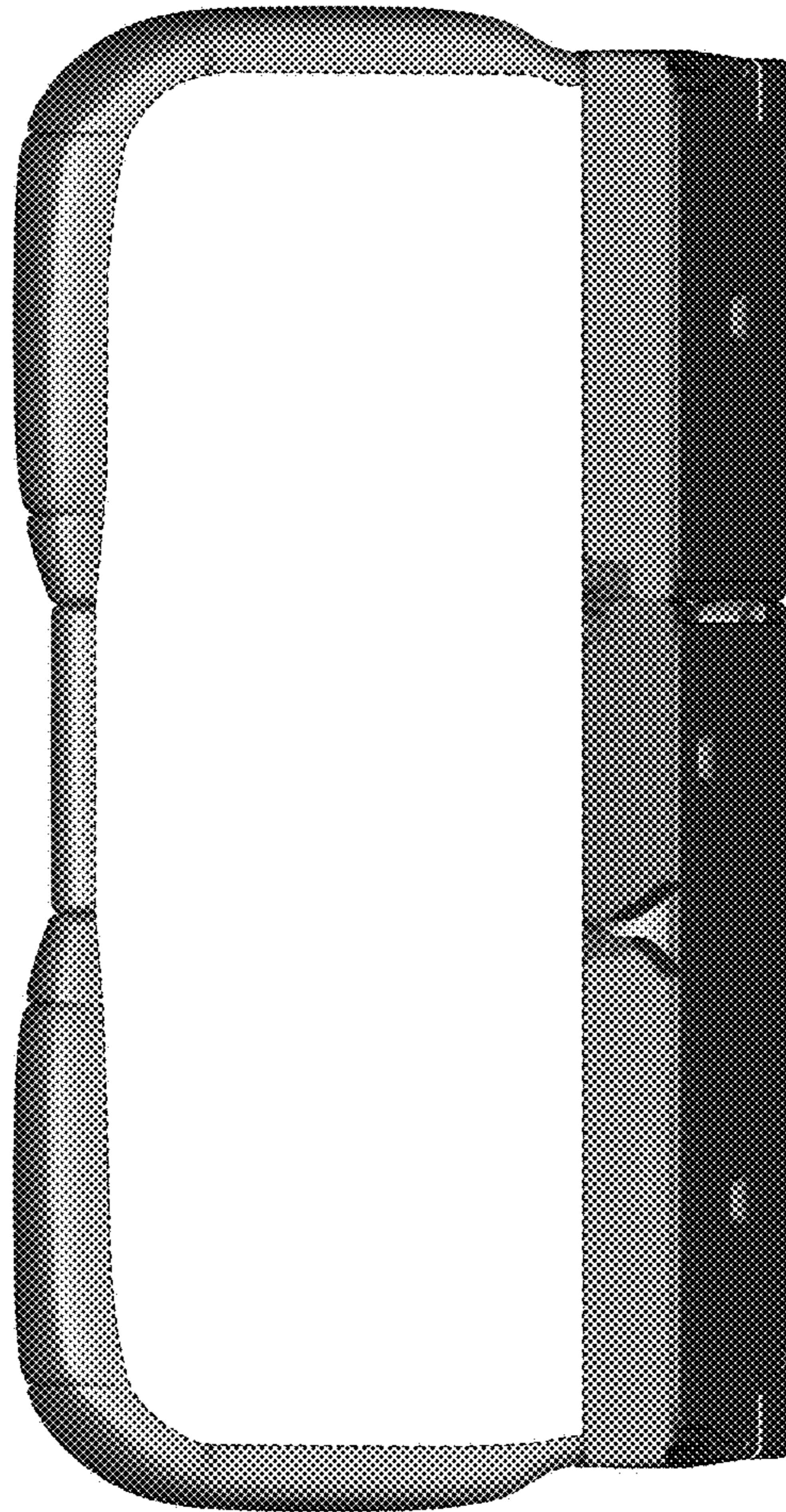

FIG. 8

UNITED STATES PATENT AND TRADEMARK OFFICE
CERTIFICATE OF CORRECTION

PATENT NO. : D804,207 S
APPLICATION NO. : 29/583131
DATED : December 5, 2017
INVENTOR(S) : Conny Blomme

Page 1 of 1

It is certified that error appears in the above-identified patent and that said Letters Patent is hereby corrected as shown below:

On the Title Page

Please add:

Item (30) Foreign Application Priority Data:

EUROPEAN UNION INTELLECTUAL PROPERTY OFFICE (EUIPO) App. No. 003108182-0002
filed May 3, 2016

Signed and Sealed this
Third Day of April, 2018

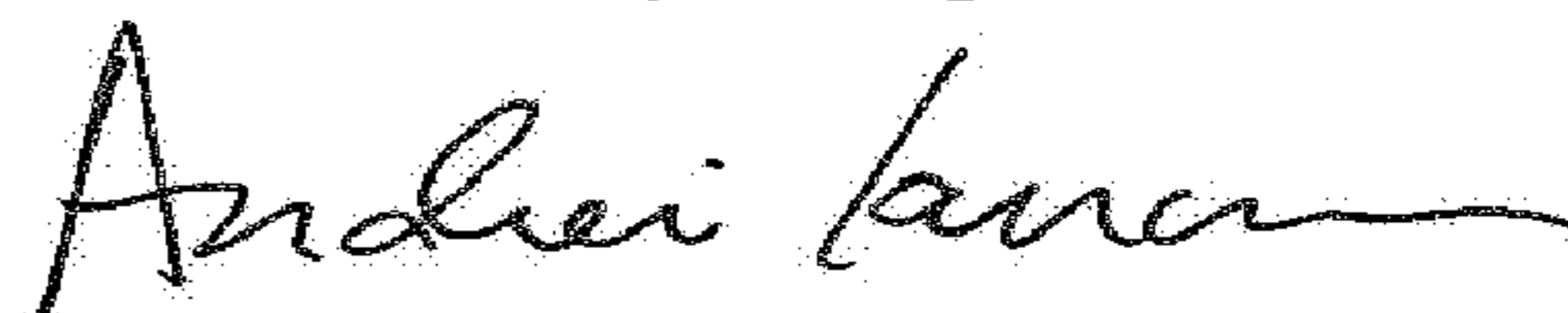

Andrei Iancu

Director of the United States Patent and Trademark Office