



US00D804123S

(12) **United States Design Patent**  
**Orsino**

(10) **Patent No.:** **US D804,123 S**

(45) **Date of Patent:** **\*\* Nov. 28, 2017**

(54) **SNOW BROOM AND SCRAPER**

(71) Applicant: **Robert A. Orsino**, Marshfield, MA  
(US)

(72) Inventor: **Robert A. Orsino**, Marshfield, MA  
(US)

(\*\*) Term: **15 Years**

(21) Appl. No.: **29/569,038**

(22) Filed: **Jun. 23, 2016**

(51) **LOC (10) Cl.** ..... **07-05**

(52) **U.S. Cl.**  
USPC ..... **D32/51**; D4/116

(58) **Field of Classification Search**  
USPC ..... D32/40-49, 50-52, 21-25, 31-33;  
D4/130-134, 118, 116  
CPC ..... A63C 11/22; A47L 23/24; A47K 7/026;  
A63B 57/0087  
See application file for complete search history.

(56) **References Cited**

U.S. PATENT DOCUMENTS

490,472 A	1/1893	Clements	
1,760,614 A *	5/1930	Weintraub	A47L 13/44 15/115
D232,299 S	8/1974	Epstein	
D235,119 S	5/1975	Code	
D278,099 S *	3/1985	Evans	D32/41
D292,949 S	12/1987	Vetter	
D305,962 S *	2/1990	Ibanez	D32/47
D307,517 S *	5/1990	Mallory	D32/41
D315,975 S	4/1991	Huang	
D355,075 S	2/1995	Stone	
D356,683 S *	3/1995	Jefferson	D32/42
D366,738 S	1/1996	Israel	
D378,322 S	3/1997	Young	
5,908,255 A	6/1999	Branch	
D414,343 S *	9/1999	Isaacson	D4/132
D444,952 S	7/2001	Mason, Jr.	
D502,001 S *	2/2005	Hay	D32/41
D511,411 S *	11/2005	Weaver	D4/132

D553,921 S *	10/2007	Melady	D8/10
D557,901 S *	12/2007	Zemel	D4/118
D561,999 S *	2/2008	Liu	D4/118
D562,003 S *	2/2008	Liu	D4/118
D568,616 S *	5/2008	Berti	D4/132
D572,487 S *	7/2008	Miller	D4/118
D575,516 S *	8/2008	Daniels	D32/49
D617,158 S	6/2010	Smith	
D636,548 S	4/2011	Hoover	

(Continued)

FOREIGN PATENT DOCUMENTS

CN	302833762	*	6/2014
CN	303695818	*	6/2016

OTHER PUBLICATIONS

Amazon.com: Hopkins 581-E Mallory Telescoping Sport Utility Snow Broom, review date Jan. 17, 2014, [https://www.amazon.com/...pkins-581-E-Mallory-Telescoping-Utility/dp/B000BQMGTG/ref=sr\\_1\\_3?s=home-garden&ie=UTF8&qid=1500776112&sr=1-3&keywords=broom+and+scraper](https://www.amazon.com/...pkins-581-E-Mallory-Telescoping-Utility/dp/B000BQMGTG/ref=sr_1_3?s=home-garden&ie=UTF8&qid=1500776112&sr=1-3&keywords=broom+and+scraper), [site visited Jul. 22, 2017 10:16:25 PM].\*

*Primary Examiner* — John Windmuller

*Assistant Examiner* — John R Yeh

(74) *Attorney, Agent, or Firm* — John P. McGonagle

(57) **CLAIM**

The ornamental design for a snow broom and scraper, as shown.

**DESCRIPTION**

FIG. 1 is a top perspective view of a snow broom and scraper showing my new design;  
FIG. 2 is front view thereof;  
FIG. 3 is a rear view thereof;  
FIG. 4 is a right side view thereof;  
FIG. 5 is a left side view thereof;  
FIG. 6 is a top view thereof; and,  
FIG. 7 is a bottom view thereof.

**1 Claim, 6 Drawing Sheets**

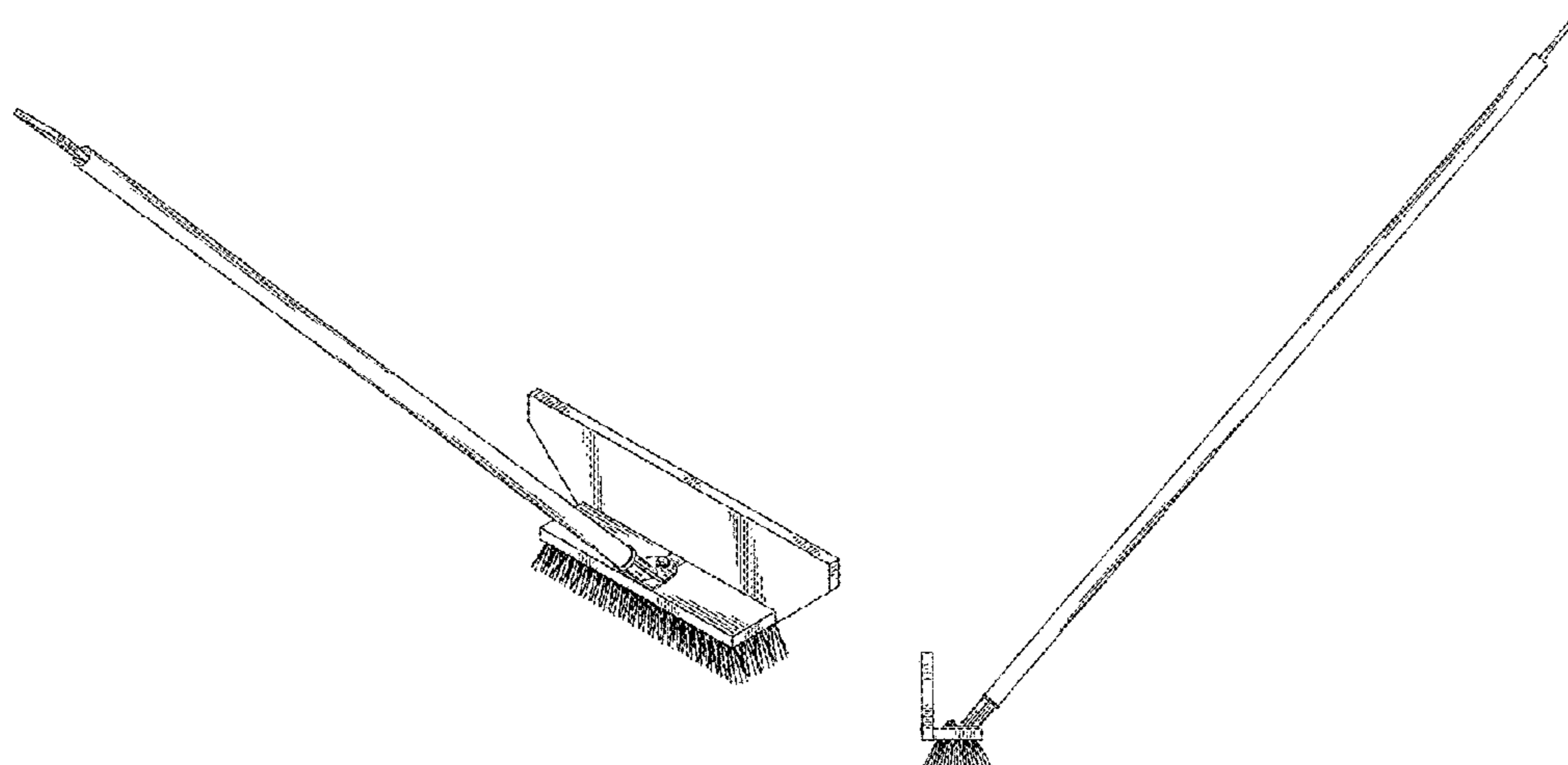

(56)

**References Cited**

U.S. PATENT DOCUMENTS

D654,697	S *	2/2012	Ross	.....	D4/116
D656,735	S *	4/2012	Zupan	.....	D4/116
D661,101	S *	6/2012	Du	.....	D4/116
D686,892	S *	7/2013	Cagle	.....	D8/10
D704,449	S *	5/2014	Lhde	.....	D4/118
D715,059	S *	10/2014	Seehoff	.....	D4/118
D738,628	S *	9/2015	Krohmer	.....	D4/118
9,408,459	B2 *	8/2016	Cooke	.....	A01B 1/20
D785,338	S *	5/2017	Henningsen	.....	D32/43

\* cited by examiner

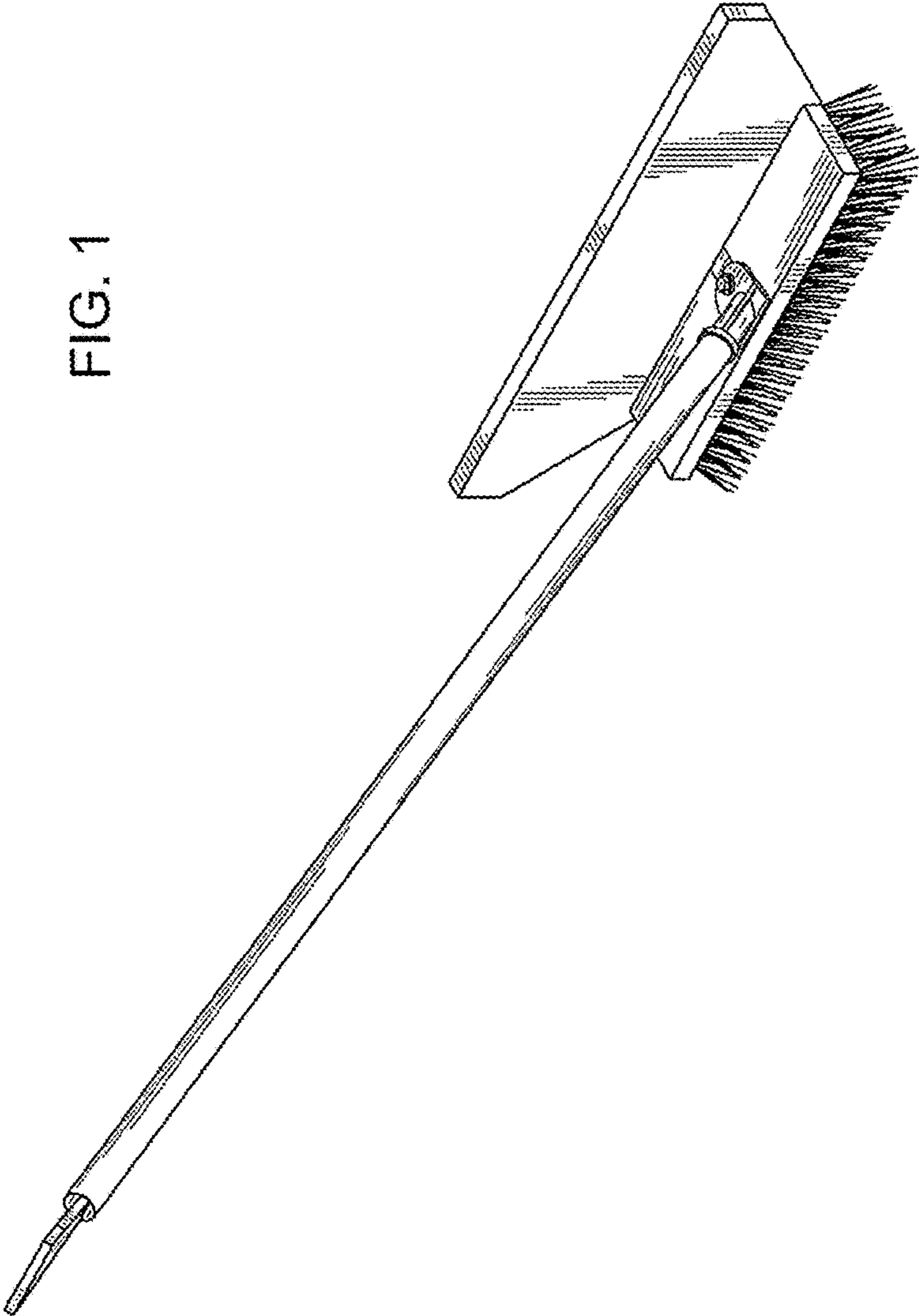

FIG. 1

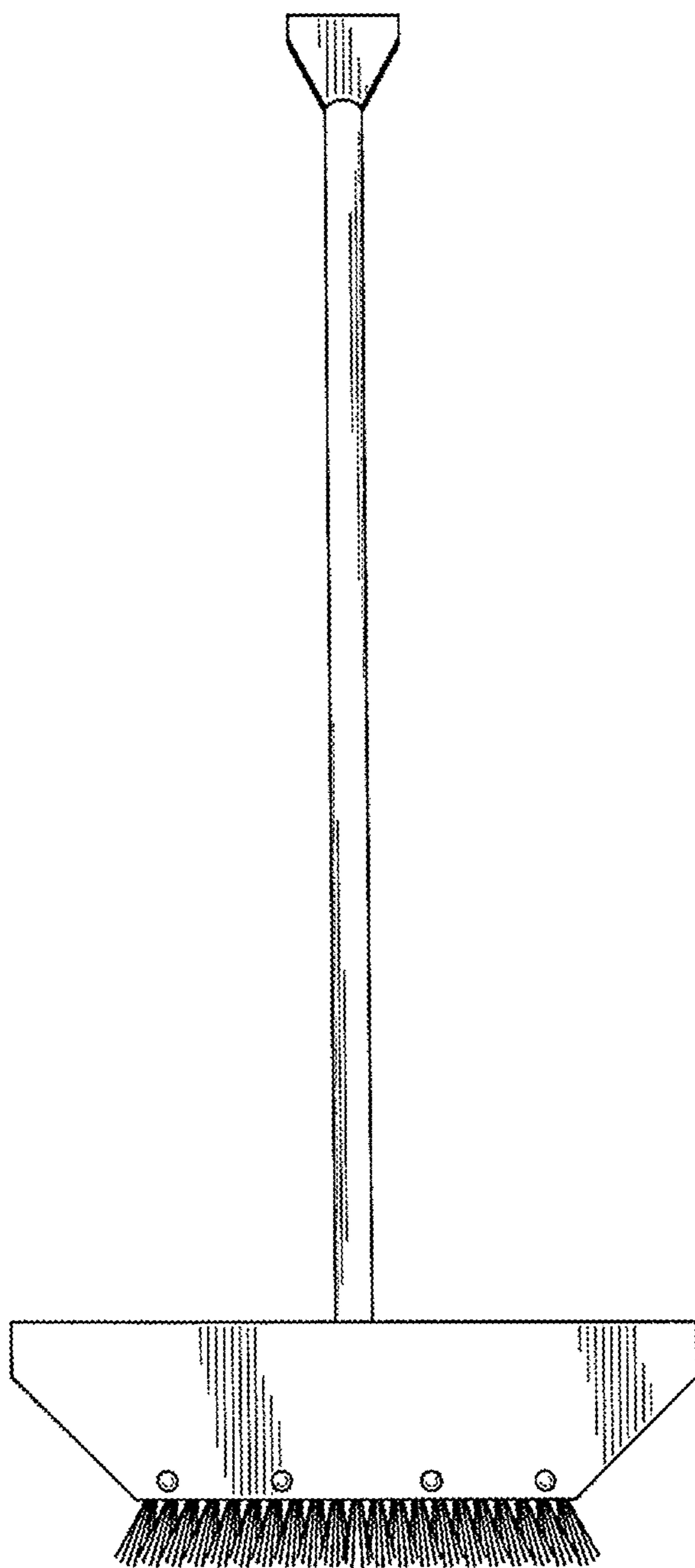

FIG. 2

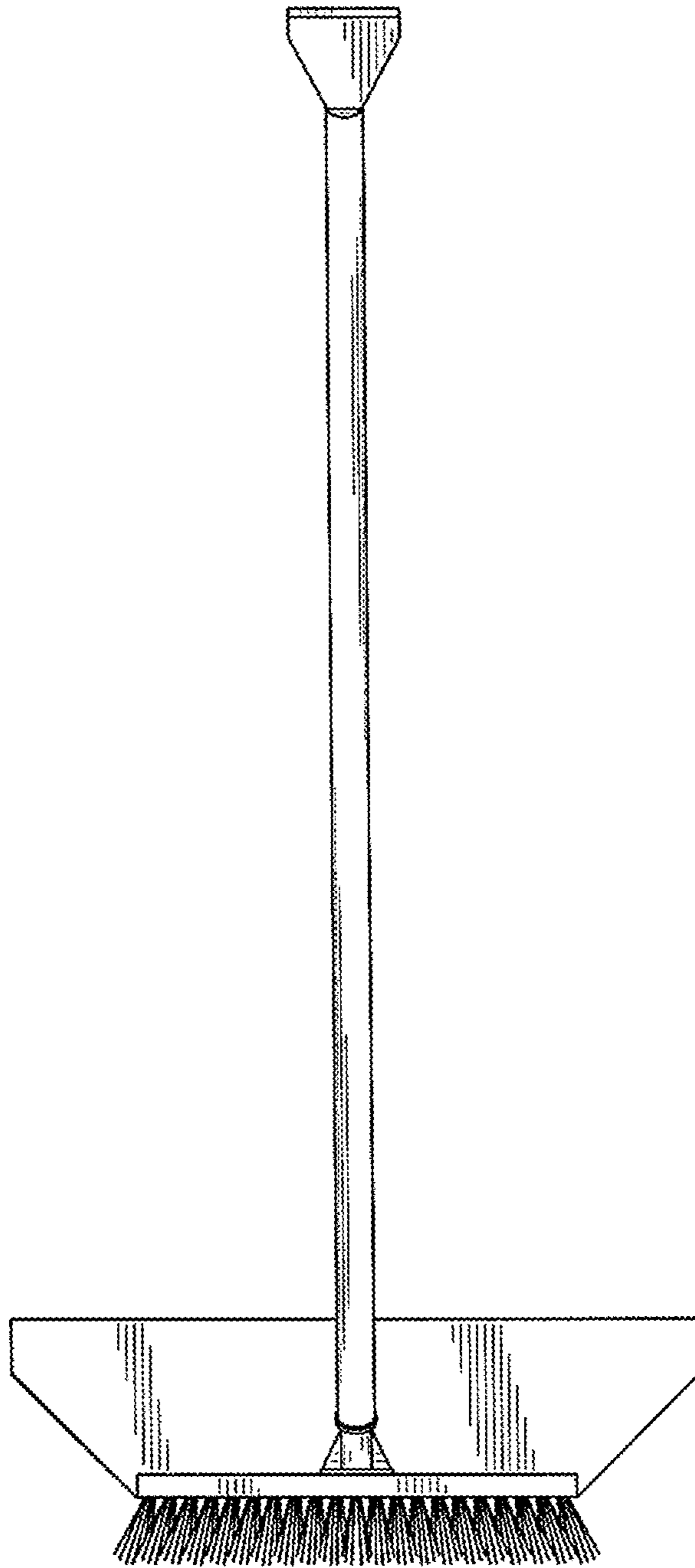

FIG. 3

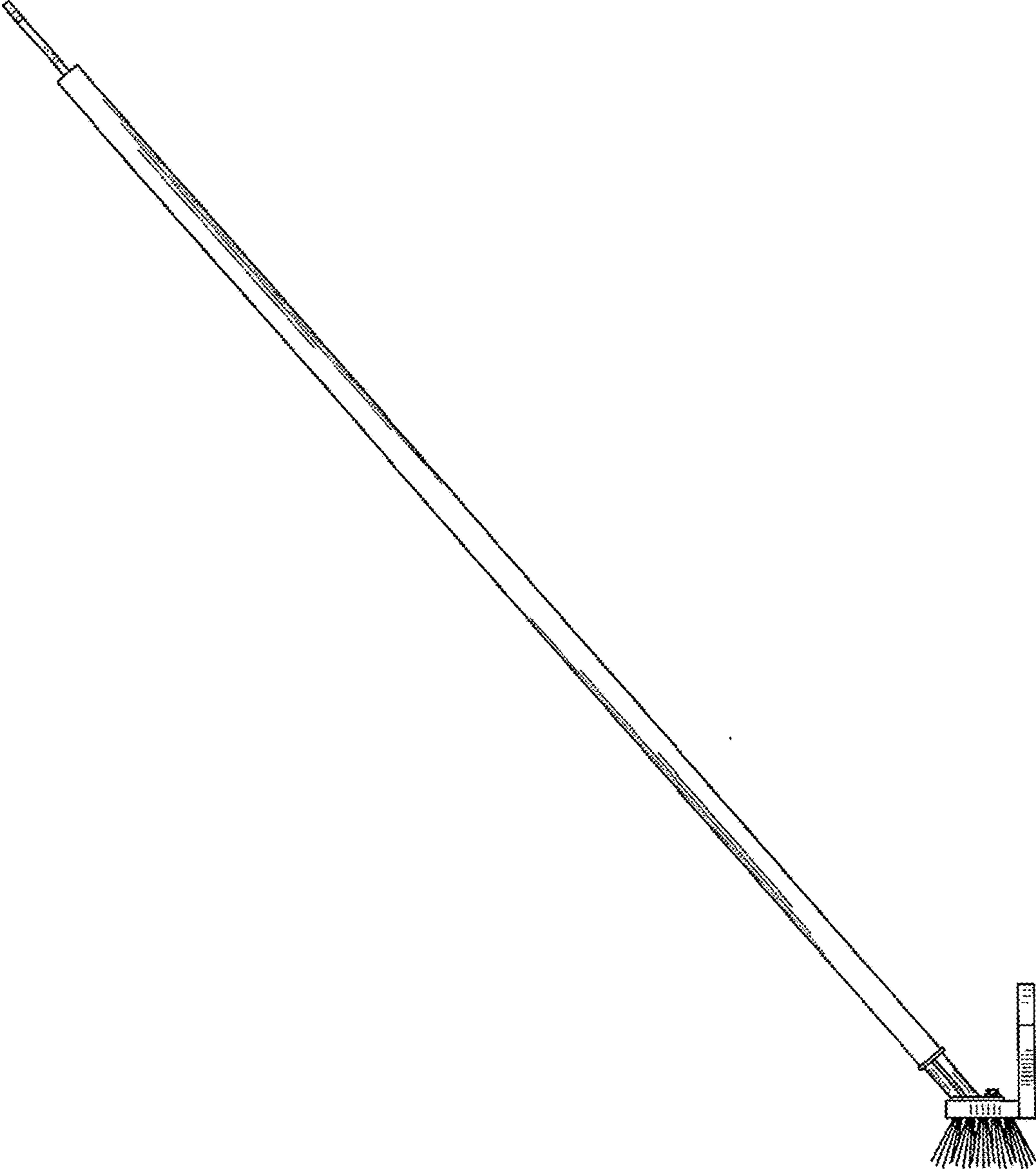

FIG. 4

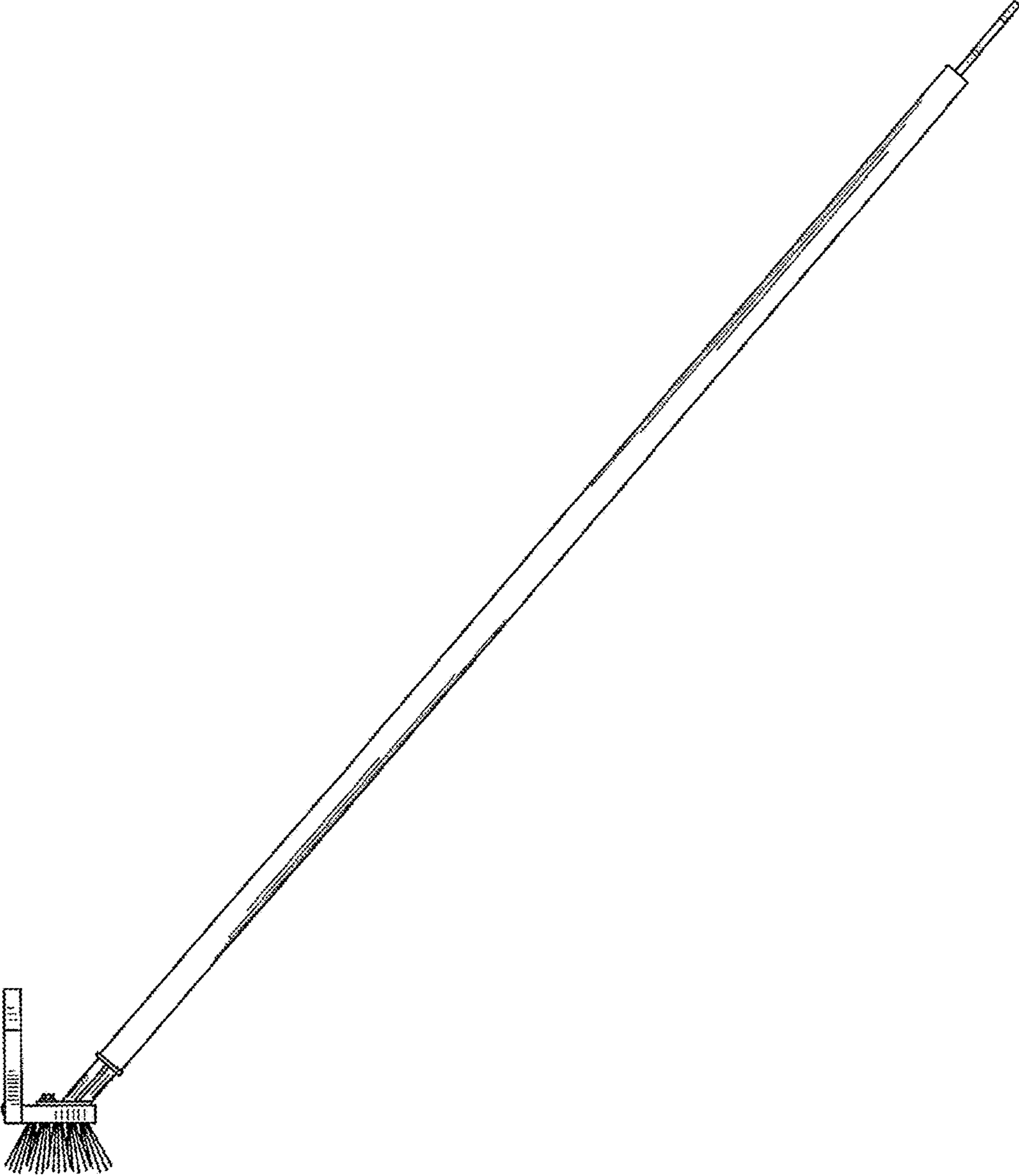

FIG. 5

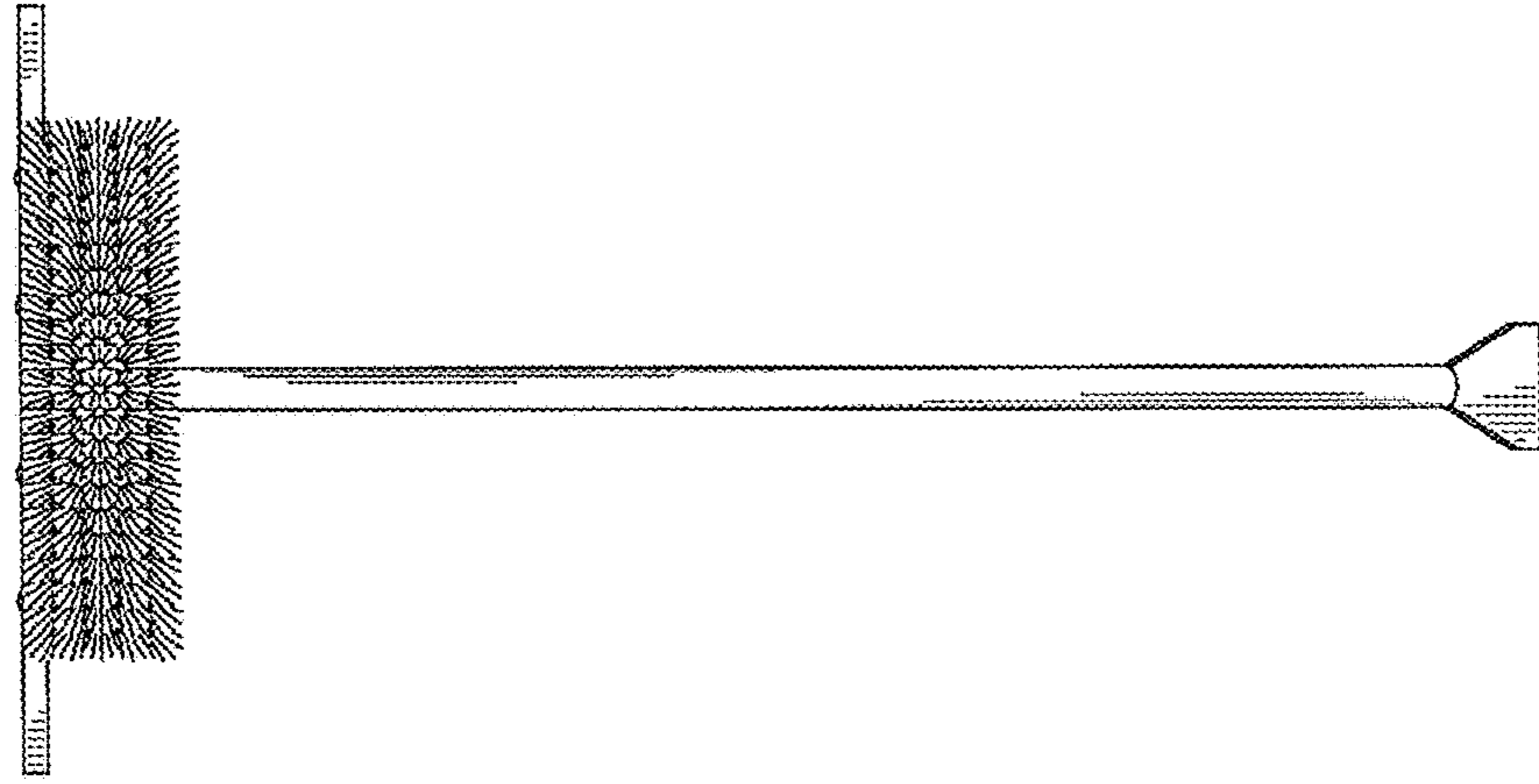

FIG. 7

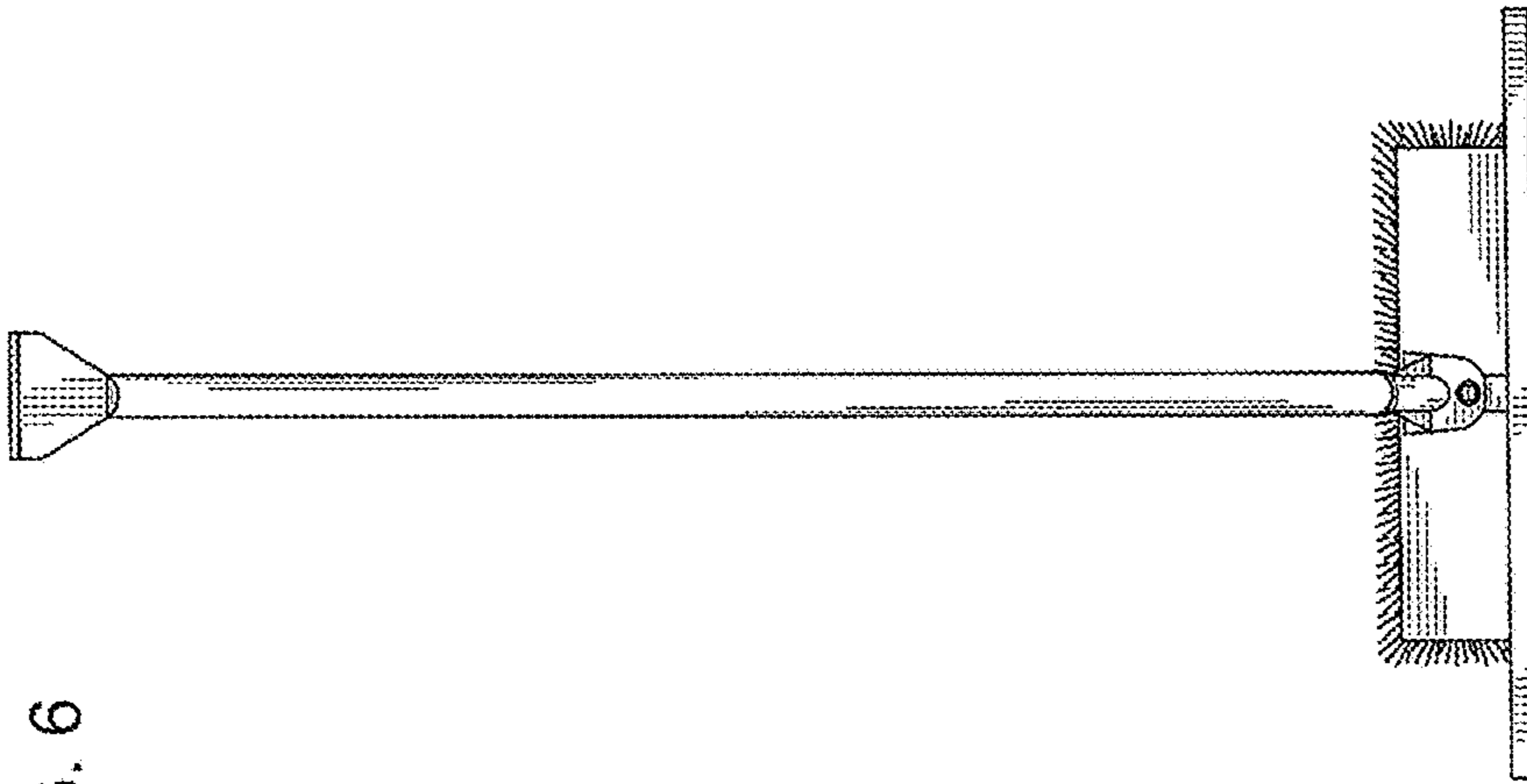

FIG. 6