



US00D804082S

(12) **United States Design Patent**
Boorum et al.

(10) **Patent No.:** **US D804,082 S**

(45) **Date of Patent:** **** *Nov. 28, 2017**

(54) **LUMINAIRE**

(71) Applicant: **QUALITE SPORTS LIGHTING, LLC**, Hillsdale, MI (US)

(72) Inventors: **M. Eric Boorum**, Jackson, MI (US);
Michael J. Boorum, Jackson, MI (US);
Nicholas D. Page, Hillsdale, MI (US);
Bret L. Buxton, Spring Lake, MI (US);
Gregory Alan Miedema, Spring Lake, MI (US)

(73) Assignee: **QUALITE SPORTS LIGHTING, LLC**, Hillsdale, MI (US)

(*) Notice: This patent is subject to a terminal disclaimer.

(**) Term: **15 Years**

(21) Appl. No.: **29/561,132**

(22) Filed: **Apr. 13, 2016**

(51) **LOC (10) Cl.** **26-99**

(52) **U.S. Cl.**
USPC **D26/118**; D26/72

(58) **Field of Classification Search**
USPC D26/63, 70, 71, 72, 76, 80, 87, 88, 89,
D26/92, 118
CPC .. F21S 8/033; F21S 8/035; F21S 8/036; F21S
8/037; F21S 8/043; F21S 8/046; F21S
8/06; F21S 8/061; F21S 8/063; F21S
8/065; F21S 8/088; F21V 17/107; F21V
5/007; F21V 21/30

See application file for complete search history.

(56) **References Cited**

U.S. PATENT DOCUMENTS

D123,048 S 10/1940 Doane
D125,120 S 10/1940 Shulman
D127,374 S * 5/1941 Jordan 362/223

D127,391 S * 5/1941 Claspy 362/223
2,259,151 A * 10/1941 Claspy F21V 17/00
362/355
D165,390 S 12/1951 Perry
D193,179 S 7/1962 Rutman et al.
3,108,751 A * 10/1963 Rodmaker F21S 8/00
362/427
D360,909 S 8/1995 Frederiksen
D370,166 S 5/1996 Decursu et al.
D381,760 S * 7/1997 Costa D26/76
D421,505 S * 3/2000 Hastings D26/76
D489,472 S * 5/2004 Newhouse D26/61
D505,744 S * 5/2005 Kan D26/76
D525,386 S * 7/2006 McCarthy, III D26/72

(Continued)

Primary Examiner — Clare E Heflin

(74) *Attorney, Agent, or Firm* — Price Heneveld LLP

(57) **CLAIM**

The ornamental design for a luminaire, as shown and described.

DESCRIPTION

FIG. 1 is a front perspective view of a luminaire according to our design;
FIG. 2 is a right elevational view thereof;
FIG. 3 is a left elevational view thereof;
FIG. 4 is a top elevational view thereof;
FIG. 5 is a front elevational view thereof;
FIG. 6 is a bottom elevational view thereof; and,
FIG. 7 is a rear elevational view thereof.
The luminaire is shown with a symbolic break in its length. The appearance of any portion of the article between the break lines forms no part of the claimed design.
The pairs of closely adjacent, spaced jagged broken lines in the drawings form no part of the claimed design and the portions between such pairs of jagged broken lines are broken away to disclose indeterminate length. Portions of the design that may be visible between the jagged lines have been removed for clarity.

1 Claim, 4 Drawing Sheets

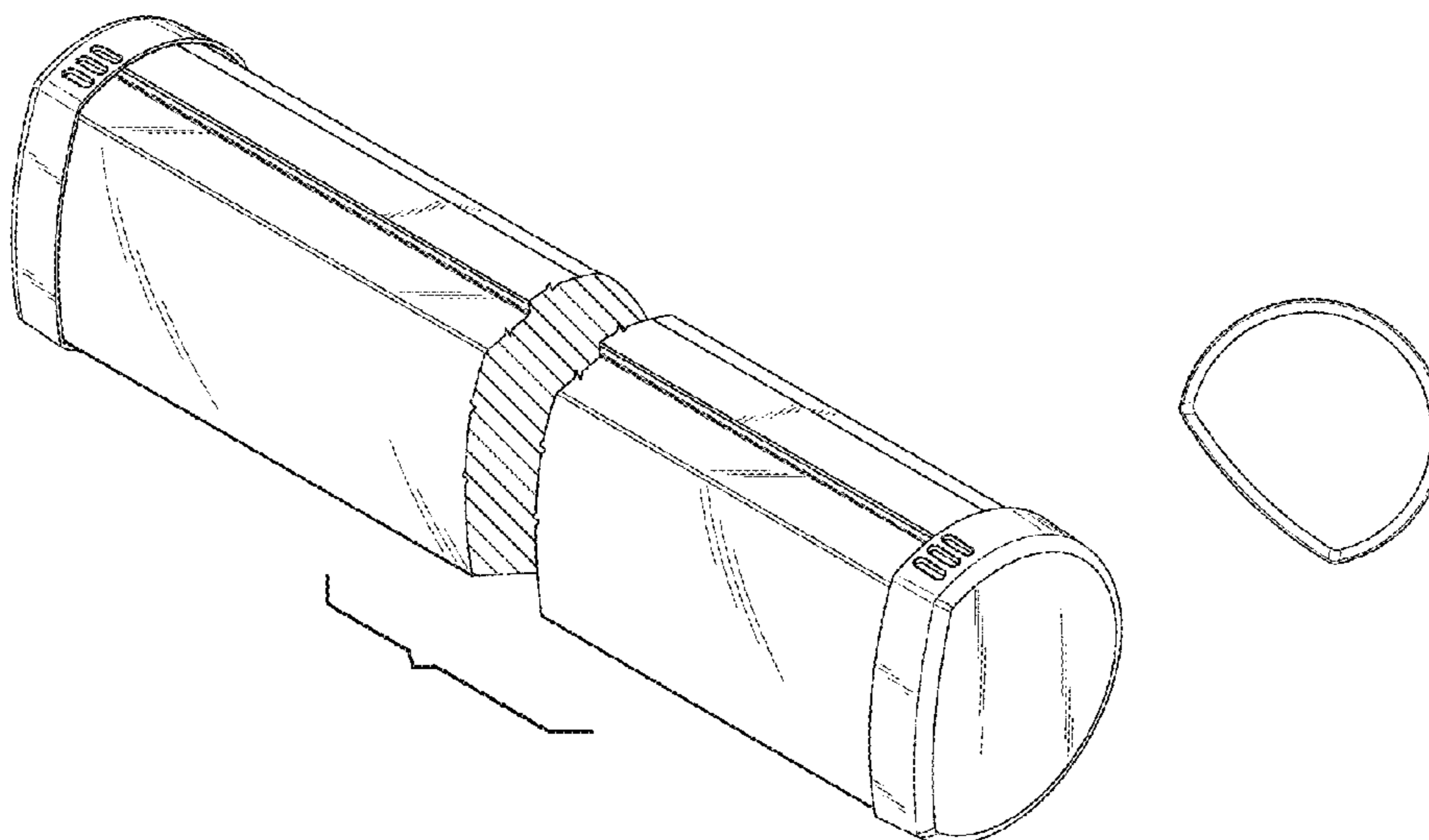

(56)

References Cited

U.S. PATENT DOCUMENTS

D526,082 S * 8/2006 McCarthy, III D26/72
 D543,305 S * 5/2007 Wang D26/60
 D572,109 S 7/2008 Busalt et al.
 D573,286 S 7/2008 Zettl
 D581,080 S 11/2008 Mier-Langner
 D589,638 S 3/2009 Collins
 D603,079 S * 10/2009 Toot D26/118
 D607,599 S * 1/2010 Zhou D26/76
 D617,488 S * 6/2010 Cho D26/76
 D693,048 S * 11/2013 Ng D26/76
 D695,943 S * 12/2013 Duquette D26/76
 D697,247 S * 1/2014 Mollaghaffari D26/76
 D724,249 S * 3/2015 Maxik D26/76
 D735,385 S 7/2015 Lee et al.
 D736,779 S 8/2015 Moon et al.
 D737,493 S 8/2015 Yasuji Fletcher et al.
 D741,683 S 10/2015 Park et al.

D754,902 S * 4/2016 Parker D26/76
 9,322,533 B1 * 4/2016 Pearson F21V 21/02
 D774,377 S 12/2016 Hilliaho
 D776,335 S 1/2017 Fizer et al.
 D781,480 S 3/2017 Zhan
 D783,874 S 4/2017 Moller
 D785,219 S 4/2017 Swai
 D785,220 S 4/2017 Swai
 2005/0117333 A1 6/2005 Yoshida et al.
 2010/0254148 A1 * 10/2010 Huang F21V 15/013
 362/373
 2010/0315812 A1 12/2010 Liu
 2011/0002124 A1 1/2011 Chang et al.
 2011/0051407 A1 * 3/2011 St. Ives F21V 15/015
 362/225
 2011/0141722 A1 * 6/2011 Acampora F21V 3/00
 362/218
 2013/0271977 A1 * 10/2013 Ronen F21V 15/013
 362/235

* cited by examiner

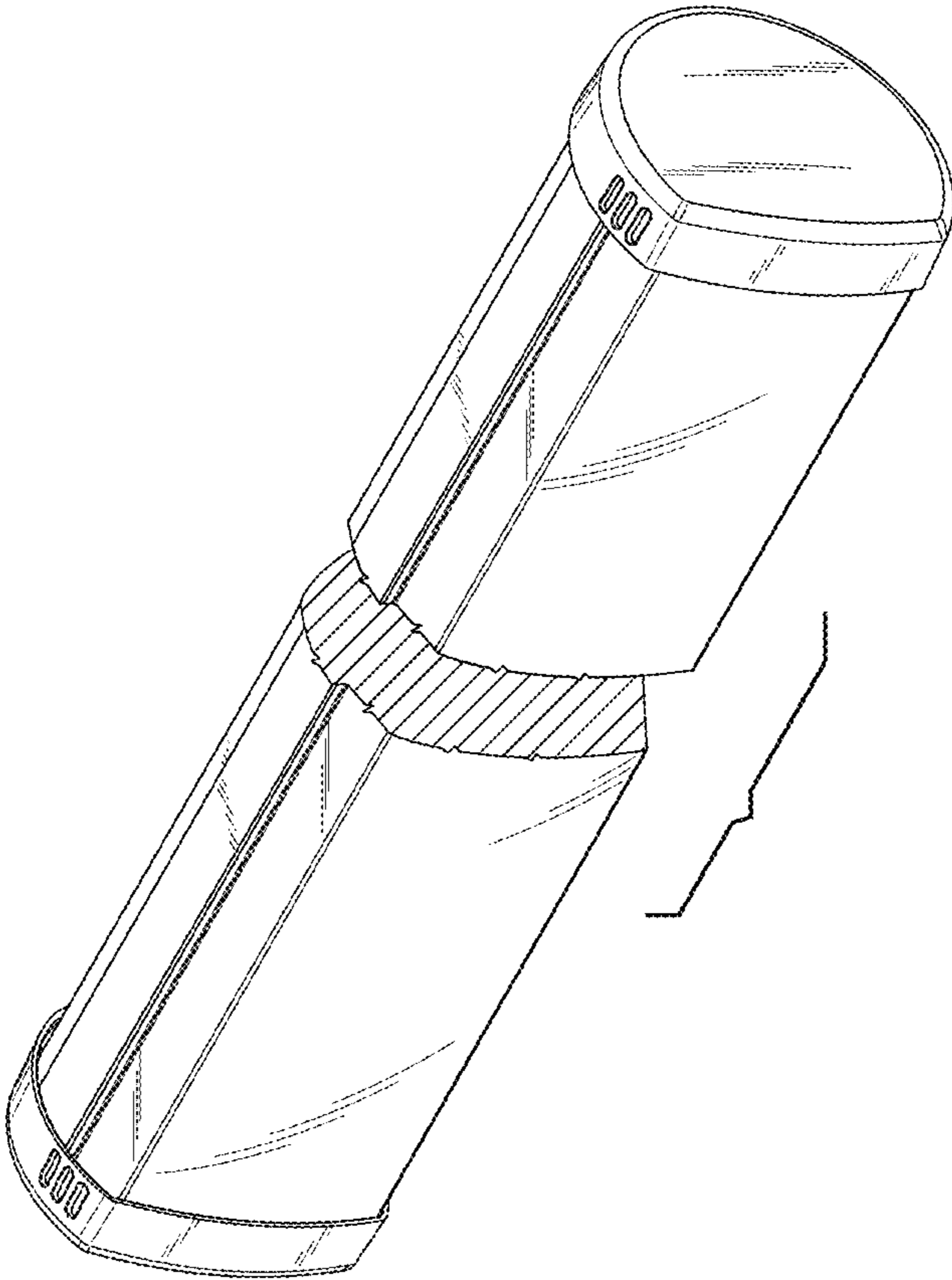

FIG. 1

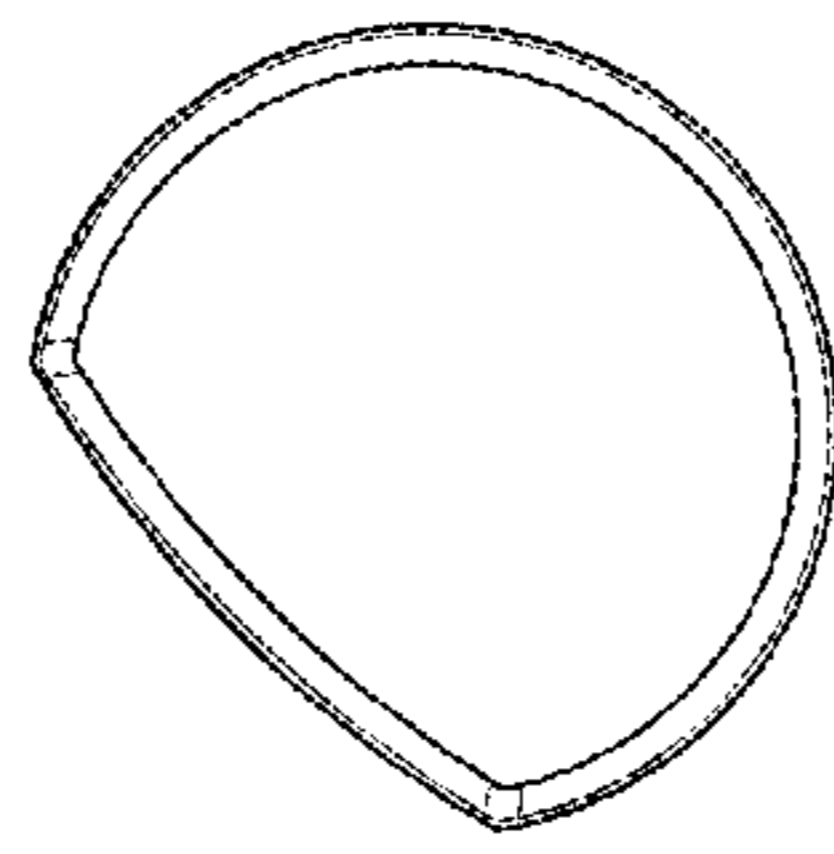

FIG. 2

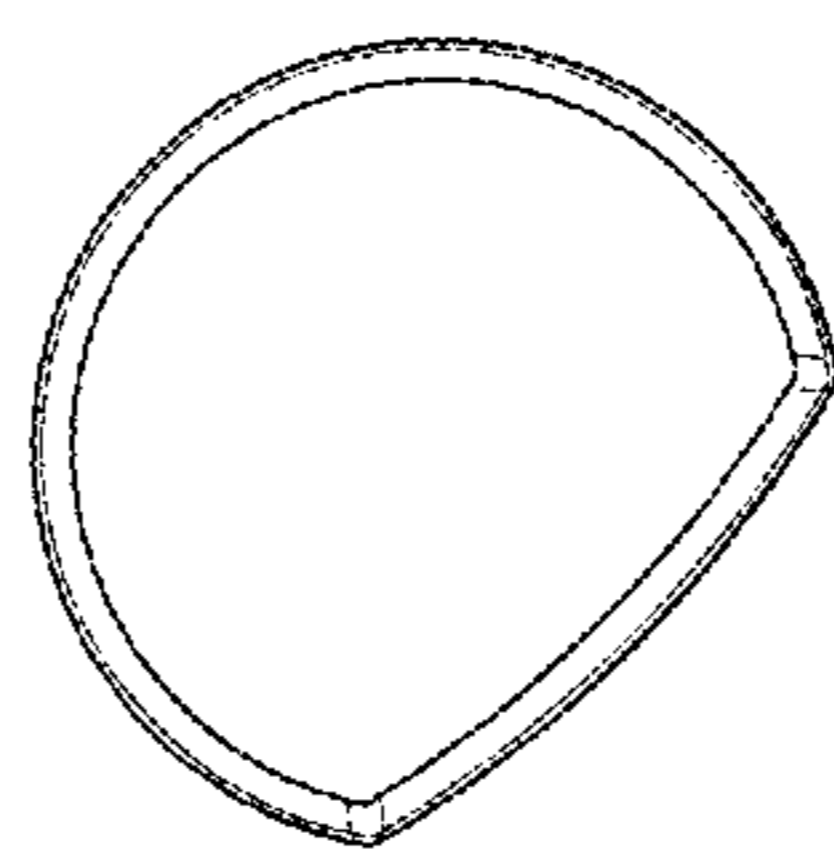

FIG. 3

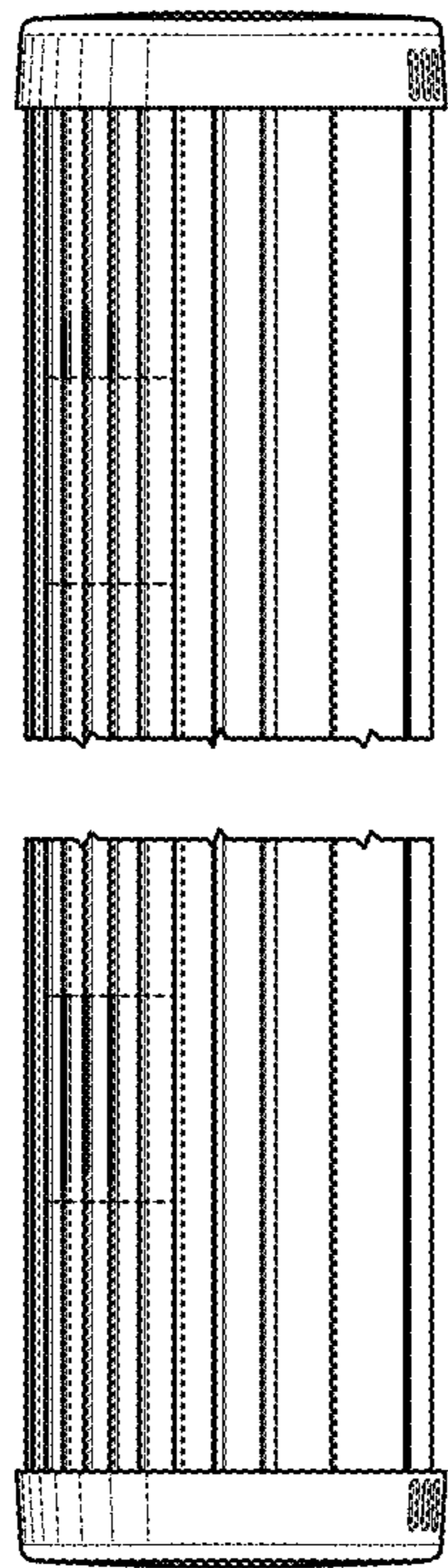

FIG. 4

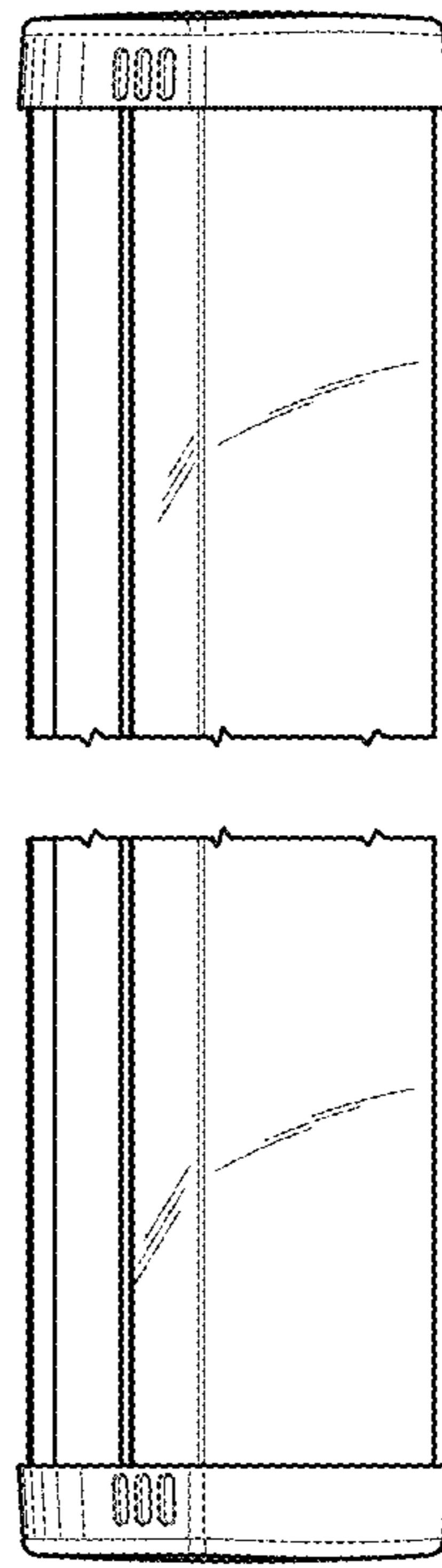

FIG. 5

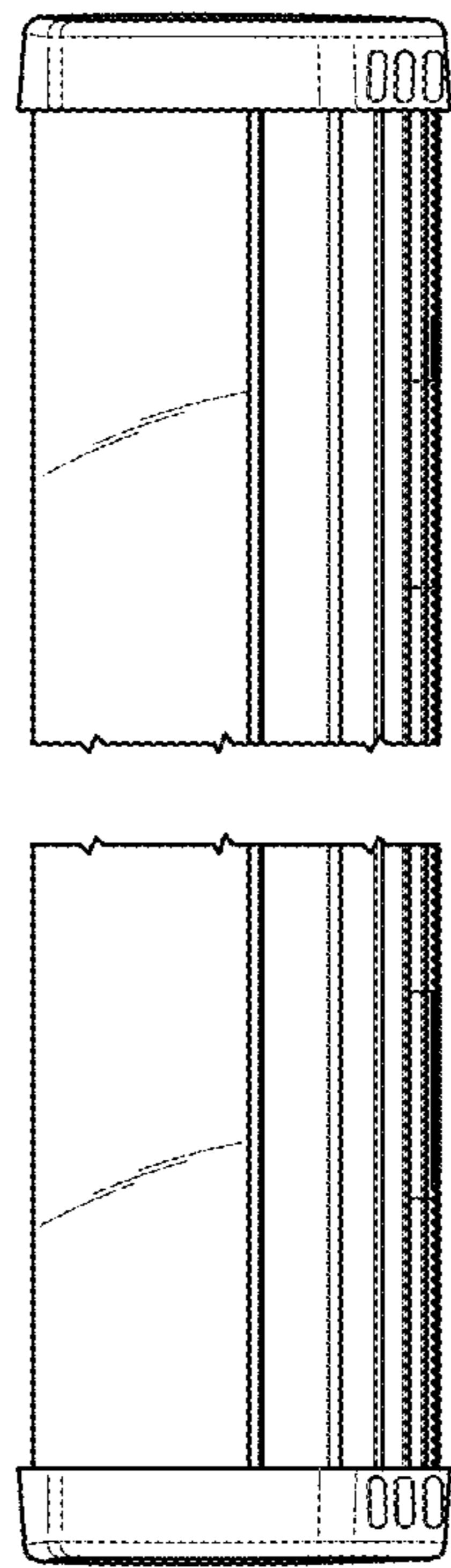

FIG. 6

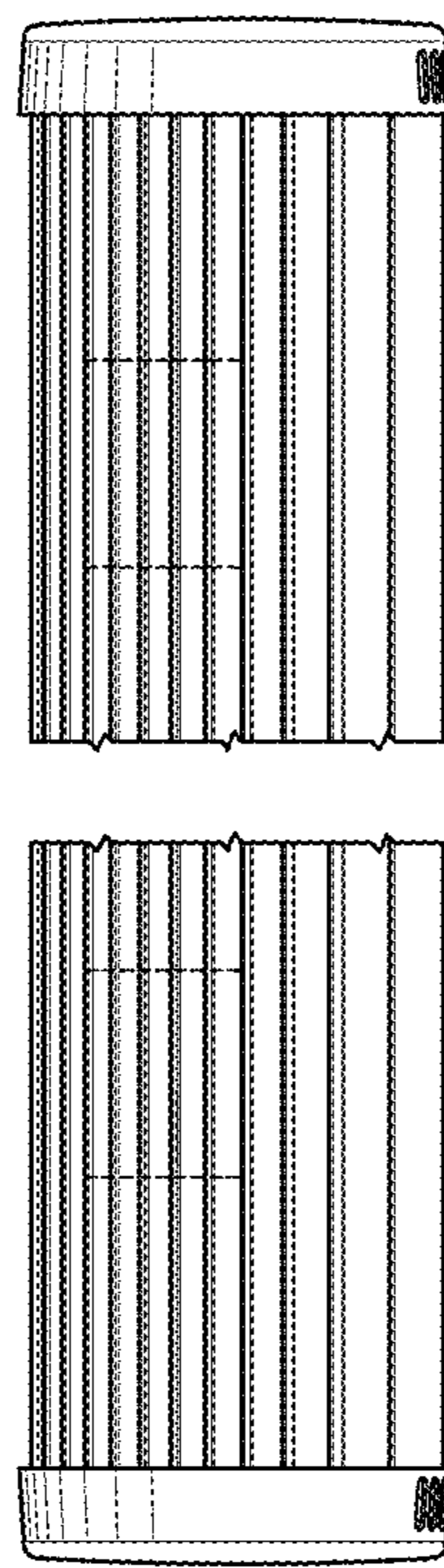

FIG. 7