



US00D804044S

(12) **United States Design Patent**
Savard

(10) **Patent No.:** **US D804,044 S**

(45) **Date of Patent:** **** Nov. 28, 2017**

(54) **ORTHOTIC FOOT BRACE**

(71) Applicant: **ORTHÈSES TURBOMED INC. /
TURBOMED ORTHOTICS INC.,
Quebec (CA)**

(72) Inventor: **Stéphane Savard, Quebec (CA)**

(73) Assignee: **ORTHESES TURBOMED
INC./TURBOMED ORTHOTICS
INC., Québec (CA)**

(**) Term: **15 Years**

(21) Appl. No.: **29/544,252**

(22) Filed: **Nov. 2, 2015**

(51) **LOC (10) Cl.** **24-01**

(52) **U.S. Cl.**
USPC **D24/192**

(58) **Field of Classification Search**
USPC D24/190-192; D29/120.1, 121.1, 122,
D29/121.2

CPC A61F 5/0111; A61F 5/0113; A61F 5/0127;
A61F 5/0585; A61F 5/0195

See application file for complete search history.

(56) **References Cited**

U.S. PATENT DOCUMENTS

5,020,523	A *	6/1991	Bodine	A61F 5/3761	128/882
D373,194	S *	8/1996	Grifka	D24/192	
D437,059	S *	1/2001	Williams	D24/190	
6,319,218	B1 *	11/2001	Birmingham	A61F 5/0127	602/23
6,428,493	B1 *	8/2002	Pior	A61F 5/0111	36/15
D503,480	S *	3/2005	Ingimundarson	D24/192	

D583,062	S *	12/2008	Nace	D24/192	
D635,269	S *	3/2011	Franke	D24/190	
8,529,484	B2 *	9/2013	Savard	A61F 5/0127	128/846
2001/0031936	A1 *	10/2001	Pior	A61F 5/0111	602/27
2004/0082895	A1 *	4/2004	Price	A61F 5/0111	602/28
2006/0270958	A1 *	11/2006	George	A61F 5/0113	602/28
2008/0243042	A1 *	10/2008	Balzer	A61F 5/0111	602/27

FOREIGN PATENT DOCUMENTS

WO 2011097723 A1 8/2011

* cited by examiner

Primary Examiner — George D Kirschbaum

Assistant Examiner — Jennifer Watkins

(74) *Attorney, Agent, or Firm* — Norton Rose Fulbright
Canada LLP; Alexandre Daoust

(57) **CLAIM**

The ornamental design for an orthotic foot brace, as shown and described.

DESCRIPTION

FIG. 1 is an oblique view of an orthotic foot brace showing my new design;

FIG. 2 is a left side elevation view thereof;

FIG. 3 is a front elevation view thereof;

FIG. 4 is a top plan view thereof;

FIG. 5 is a rear elevation view thereof; and,

FIG. 6 is a bottom view thereof.

The broken lines are for the purpose of illustrating portions of an orthotic foot brace that form no part of the claim.

1 Claim, 6 Drawing Sheets

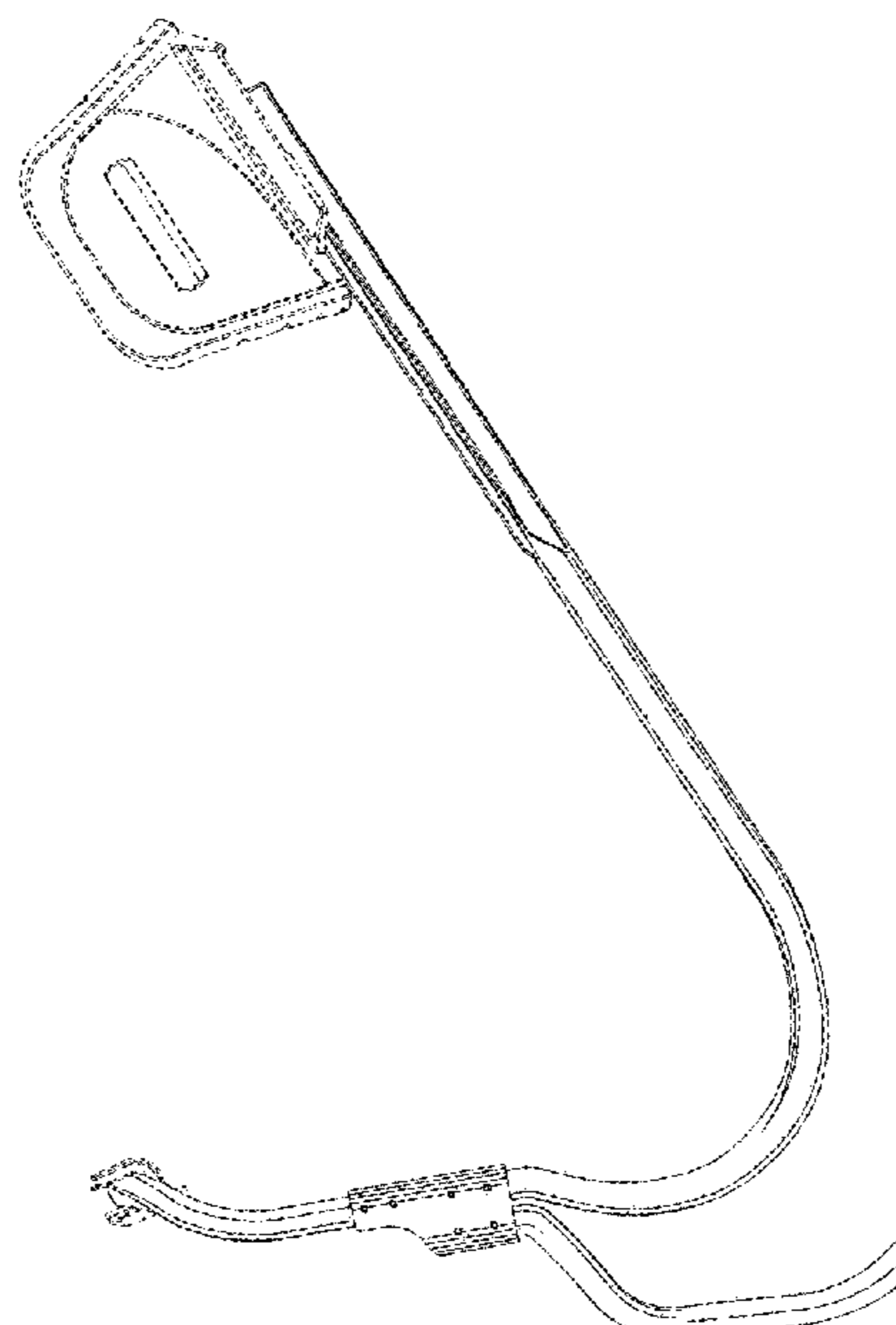
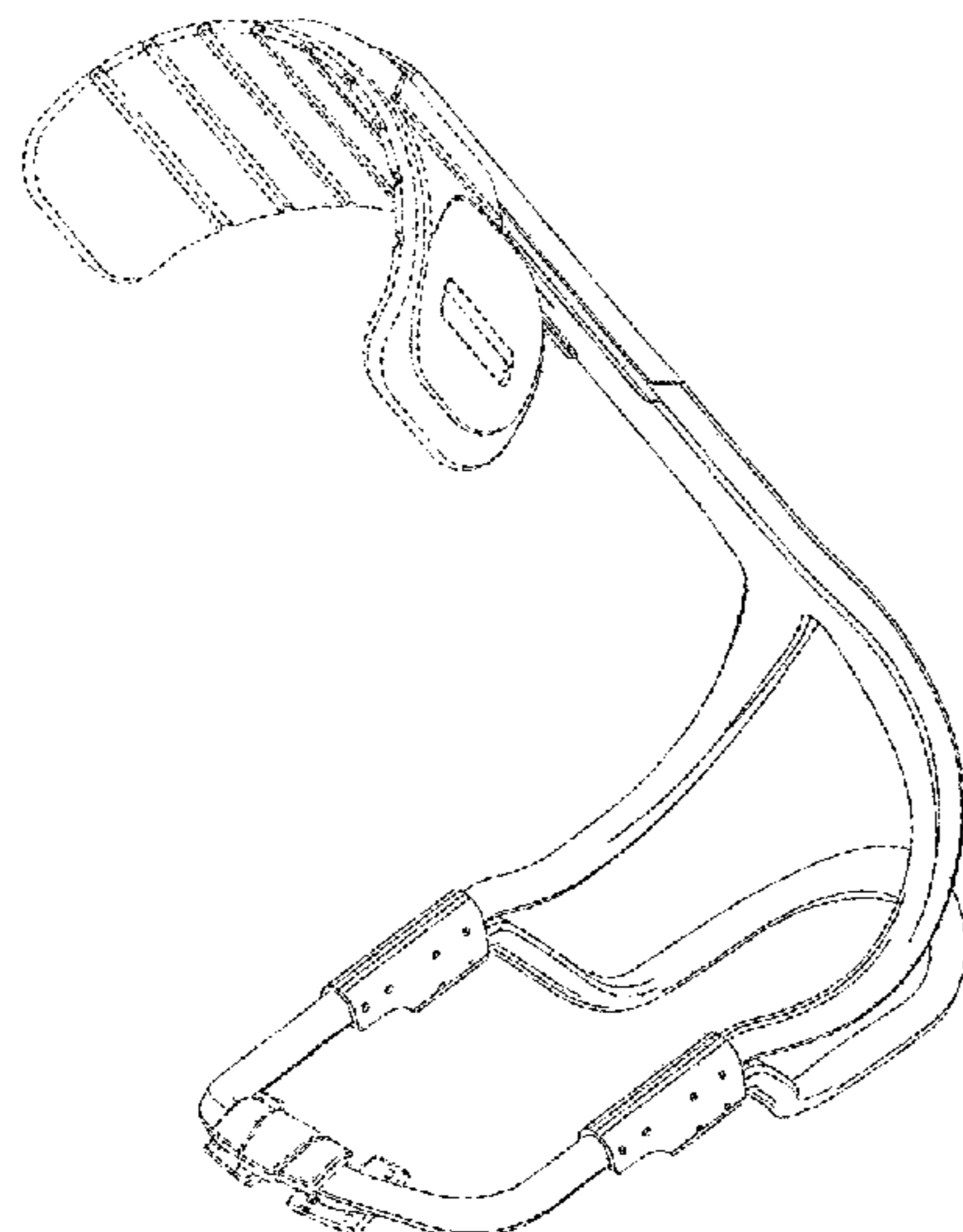

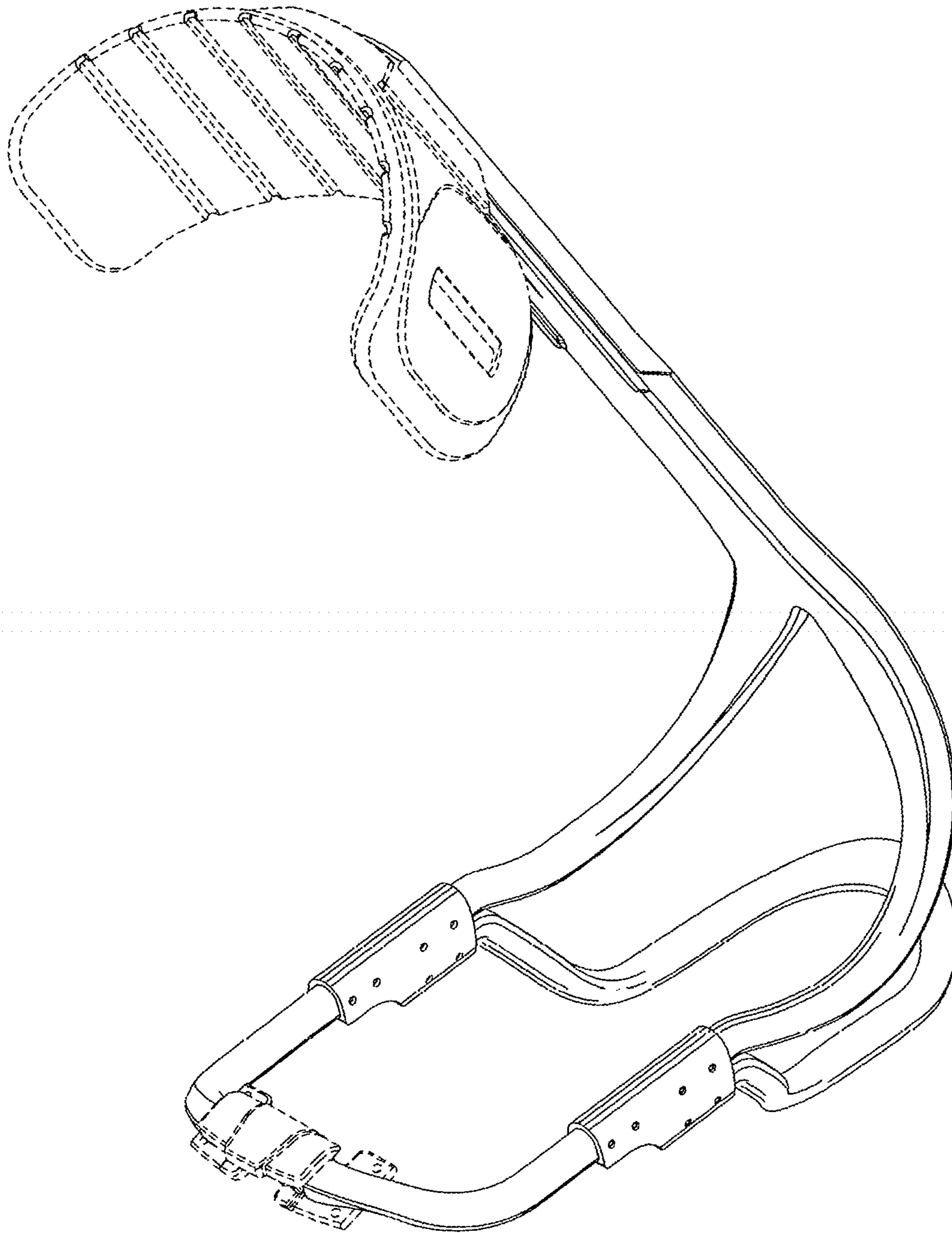

FIG. 1

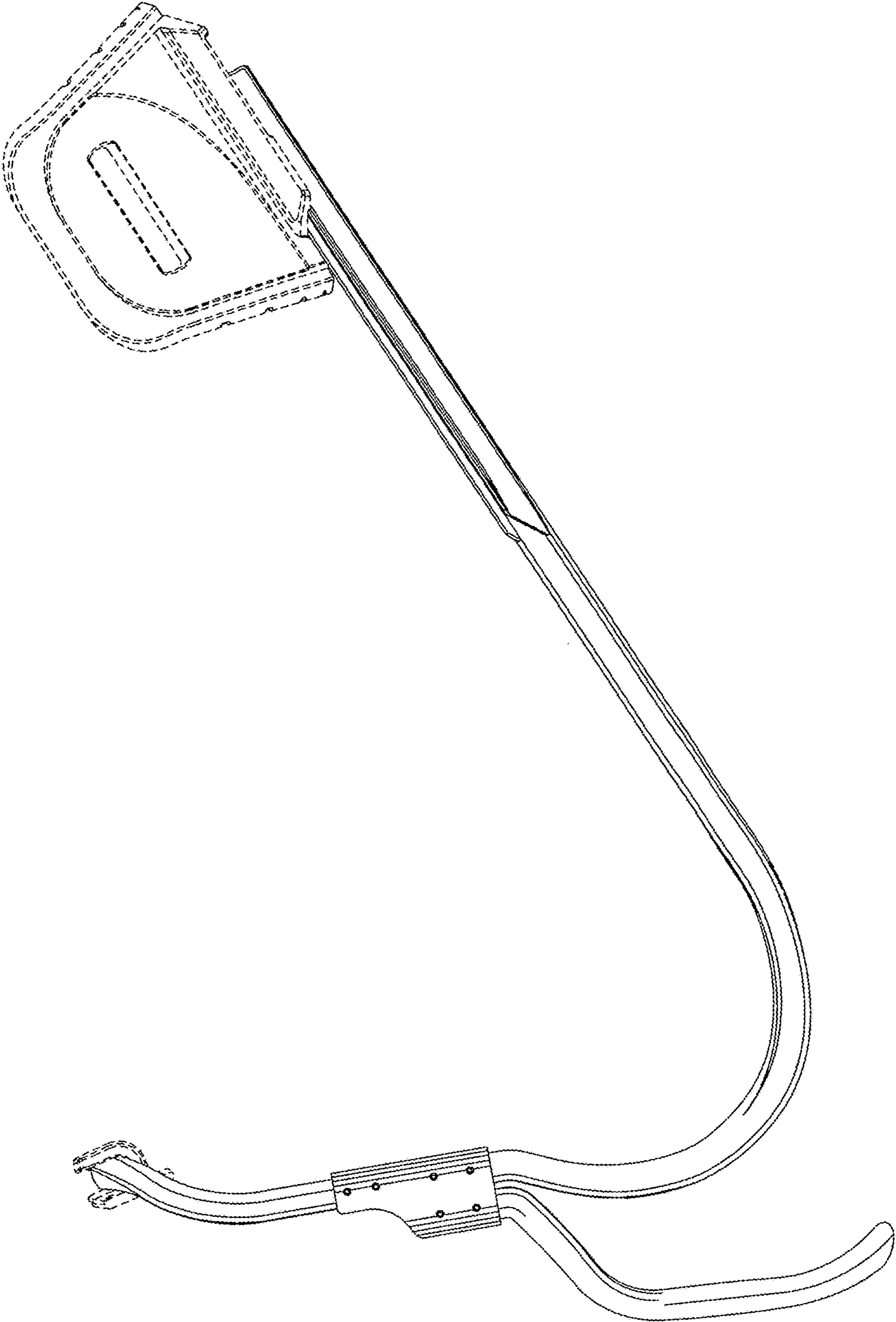

FIG. 2

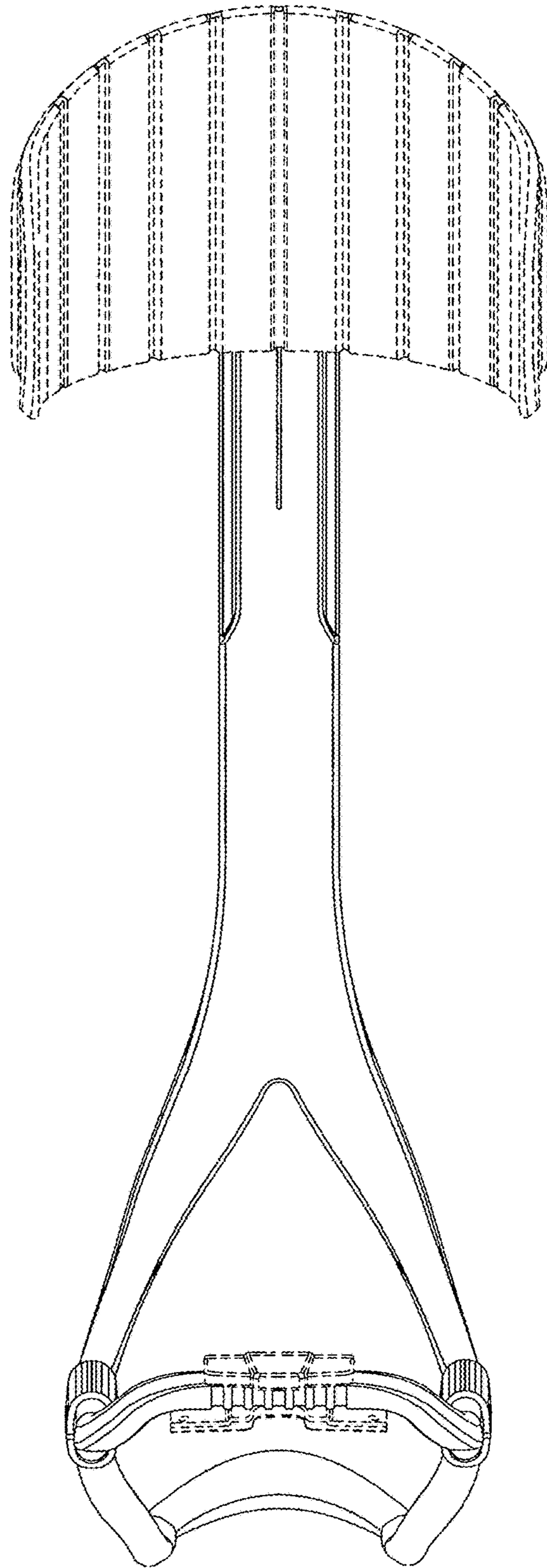

FIG. 3

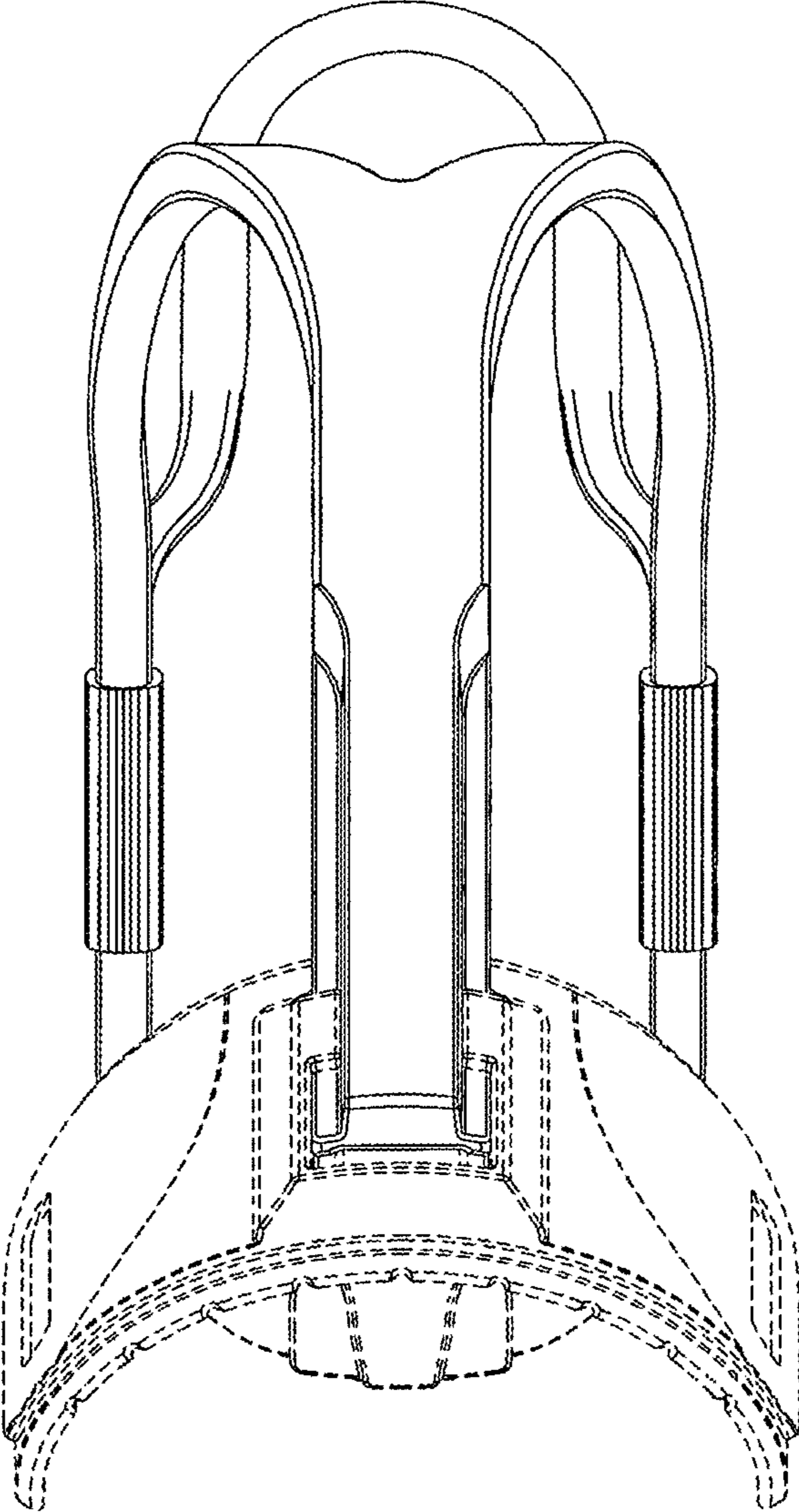

FIG. 4

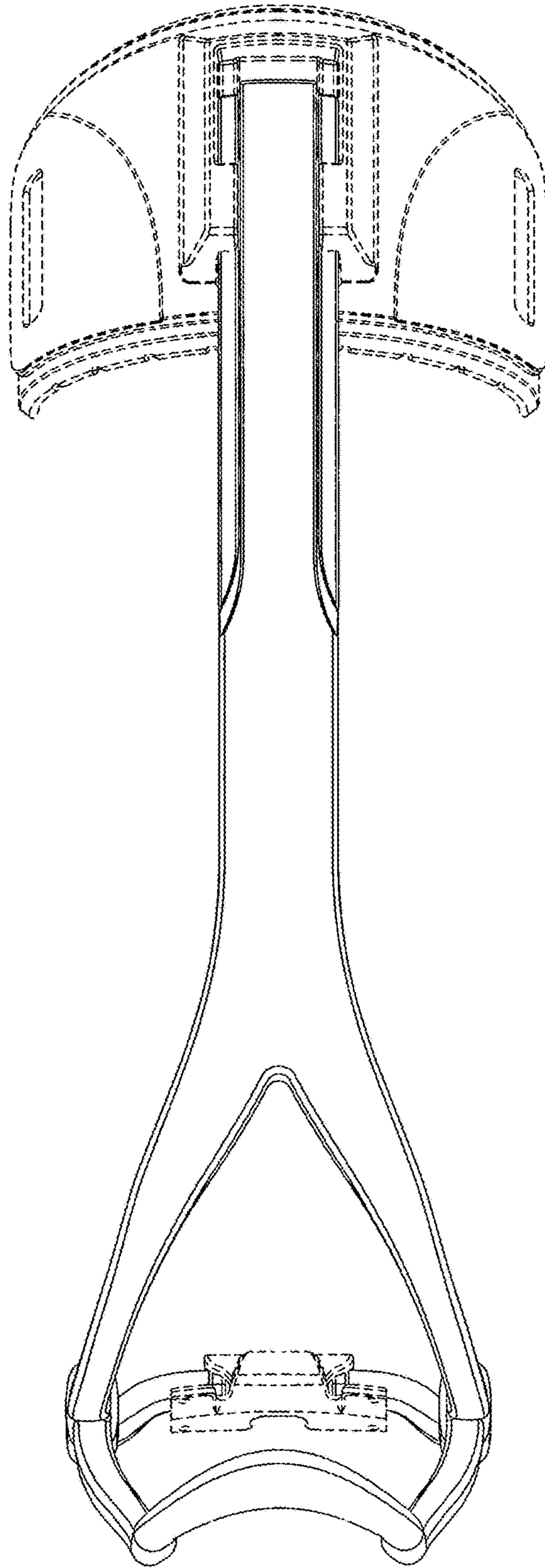

FIG. 5

