



US00D804003S

(12) **United States Design Patent**
Zhao et al.

(10) **Patent No.:** **US D804,003 S**

(45) **Date of Patent:** **** Nov. 28, 2017**

(54) **AUTOMOTIVE AIR PURIFIER**

CPC ... A61L 9/02; A61L 9/03; A61L 9/034; A61L 9/04; A61L 9/12; A61L 9/032; A61L 9/122; A61L 9/127; A61L 9/22

(71) Applicant: **KONINKLIJKE PHILIPS N.V.**,
Eindhoven (NL)

See application file for complete search history.

(72) Inventors: **KeYong Zhao**, Shanghai (CN); **Chen Cai**, Shanghai (CN)

(56) **References Cited**

(73) Assignee: **KONINKLIJKE PHILIPS N.V.**,
Eindhoven (NL)

U.S. PATENT DOCUMENTS

(**) Term: **15 Years**

D399,943 S *	10/1998	Ko	D23/355
D608,433 S *	1/2010	Murai	D23/364
D657,036 S *	4/2012	Vetu	D23/364
D665,485 S *	8/2012	Vetu	D23/364
D674,069 S *	1/2013	Vetu	D23/364

(21) Appl. No.: **35/500,689**

* cited by examiner

(22) Filed: **Sep. 9, 2015**

Primary Examiner — Keli L Hill

(80) **Hague Agreement Data**

(74) *Attorney, Agent, or Firm* — Baker & McKenzie LLP

Int. Filing Date: **Sep. 9, 2015**

Int. Reg. No.: **DM/088612**

Int. Reg. Date: **Sep. 9, 2015**

Int. Reg. Pub. Date: **Mar. 11, 2016**

(57) **CLAIM**

The ornamental design for an automotive air purifier, as shown and described.

(30) **Foreign Application Priority Data**

Mar. 10, 2015 (EM) 002649350-0001

(51) **LOC (10) Cl.** **23-04**

(52) **U.S. Cl.**
USPC **D23/364**

(58) **Field of Classification Search**
USPC D23/355-369; D28/5, 6; 261/DIG. 17, 261/DIG. 42, DIG. 47, DIG. 55, DIG. 65, 261/DIG. 70, DIG. 88, DIG. 89; 392/386, 392/389, 394, 395, 403; 239/34, 44, 45, 239/53, 56

DESCRIPTION

1. Automotive air purifier
- 1.1 is a front elevation view.
- 1.2 is a rear elevation view.
- 1.3 is a right side elevation view.
- 1.4 is a left side elevation view.
- 1.5 is a bottom plan view.
- 1.6 is a top-right perspective view.
- 1.7 is a top plan view.

The broken-line disclosure of elements is understood to represent unclaimed portions of the article which form no part of the claimed design.

1 Claim, 7 Drawing Sheets

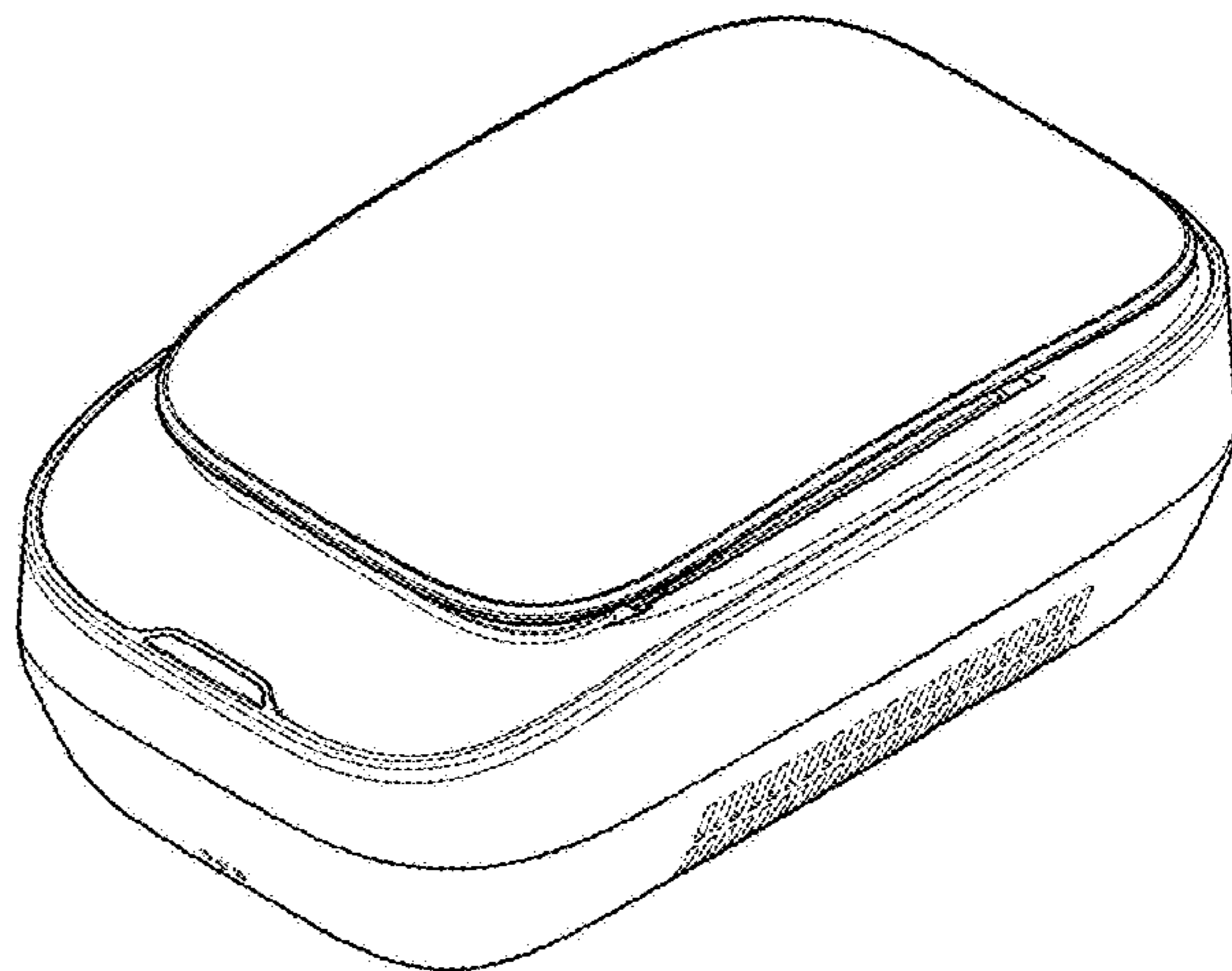
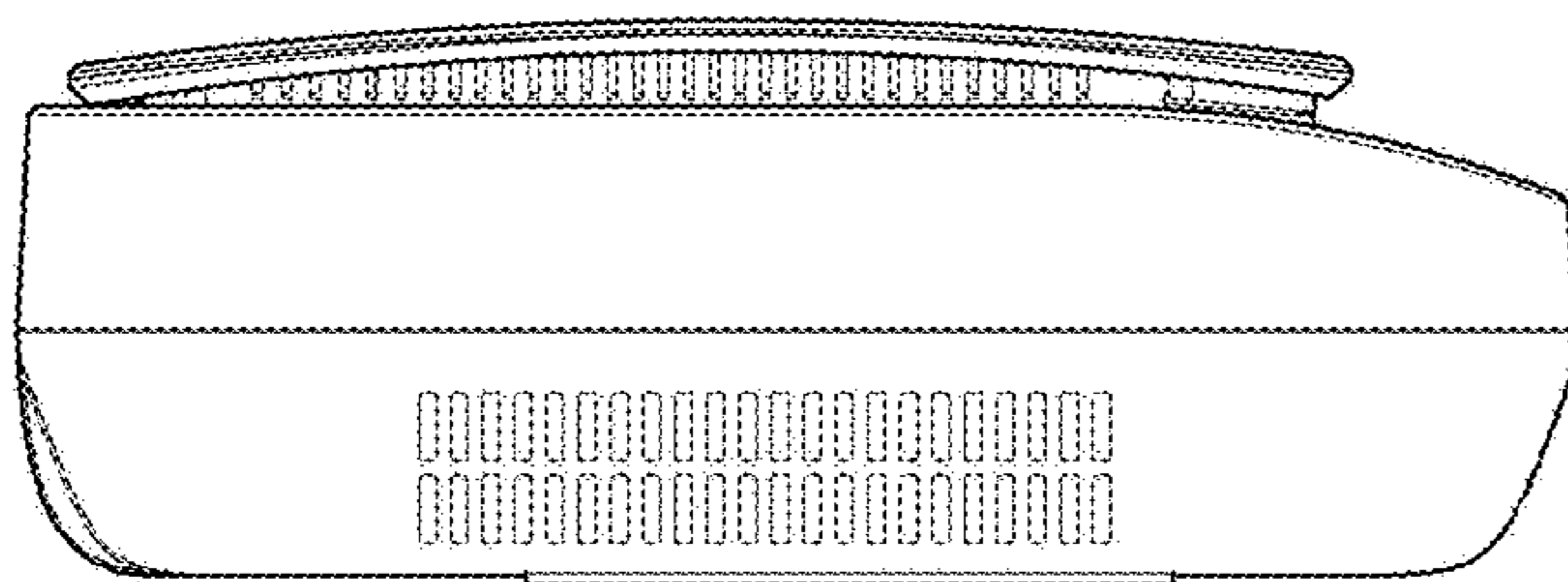

1.1

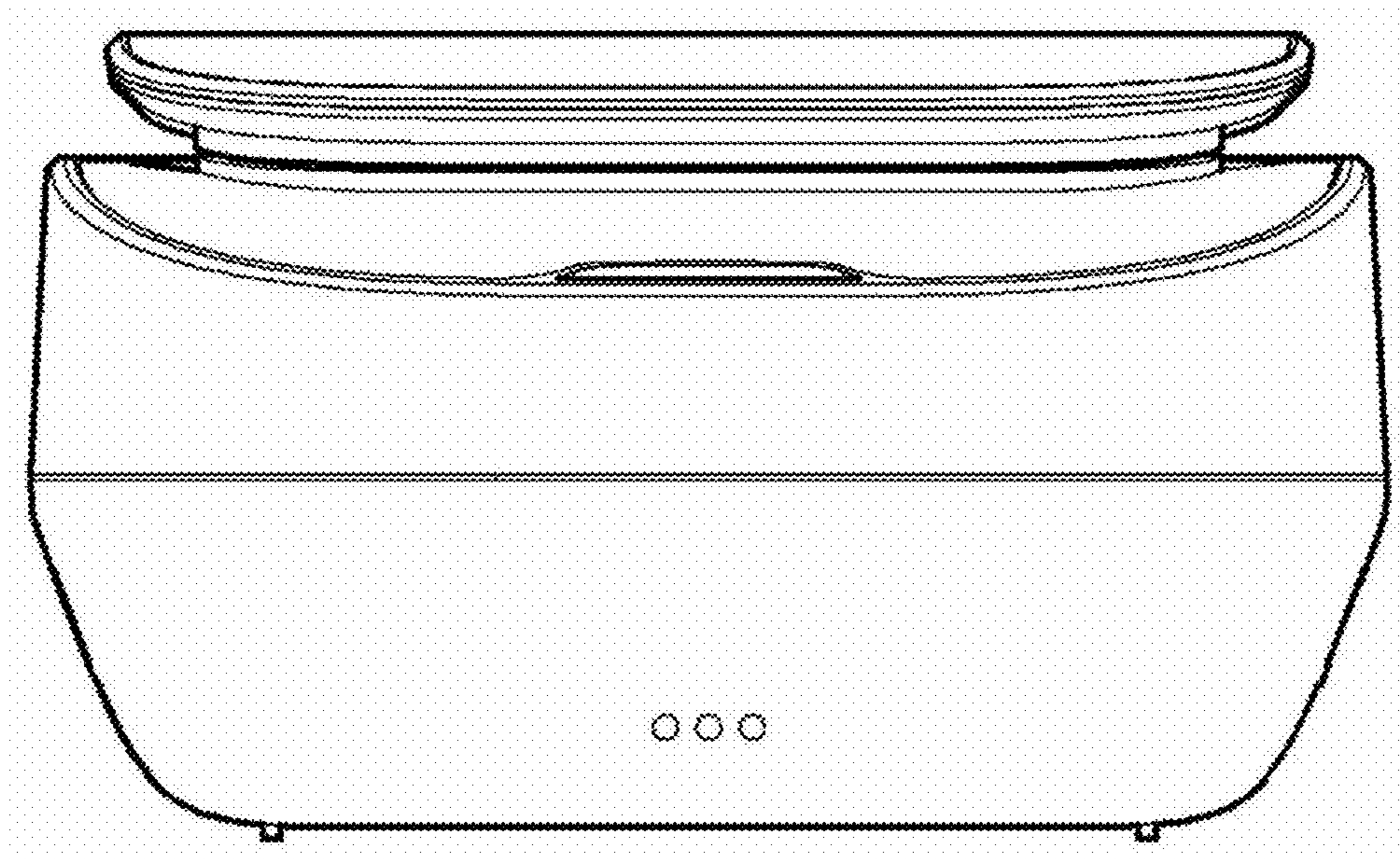

1.2

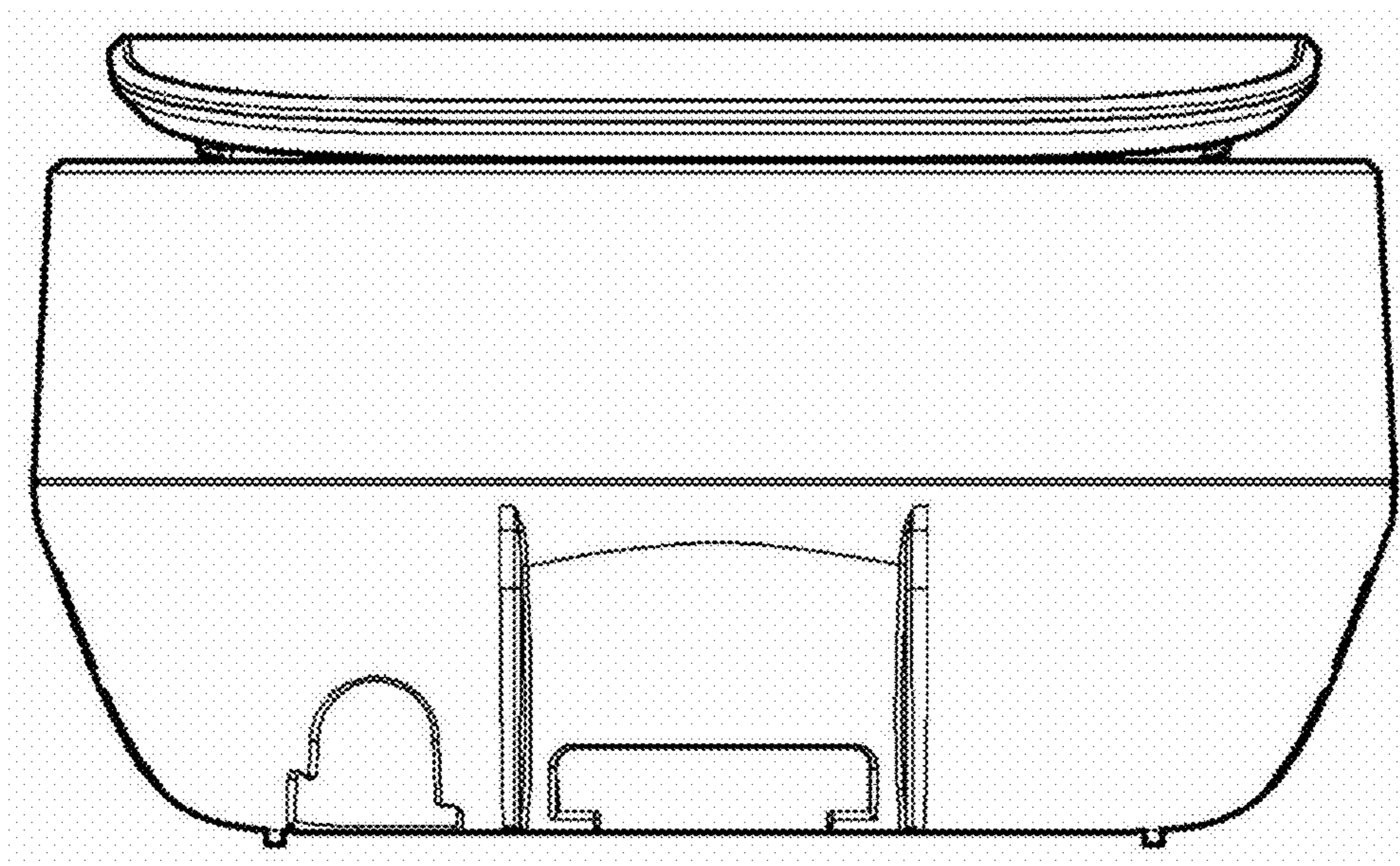

1.3

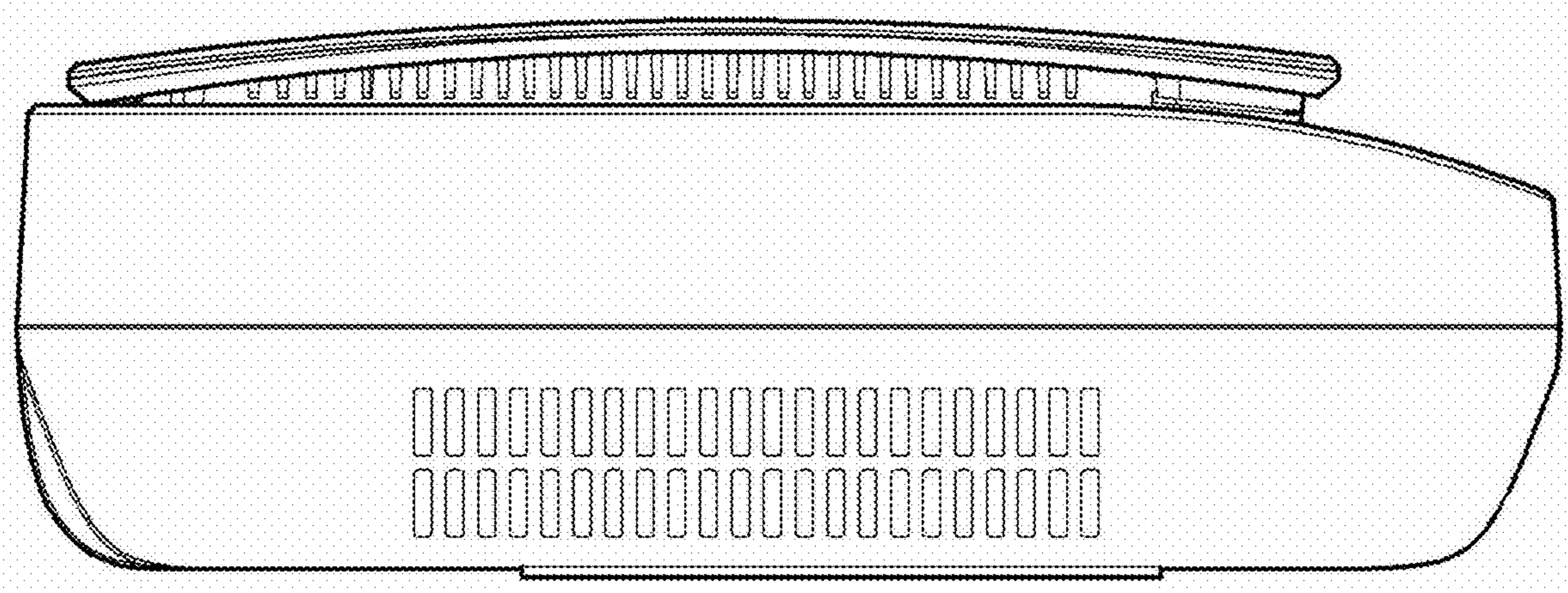

1.4

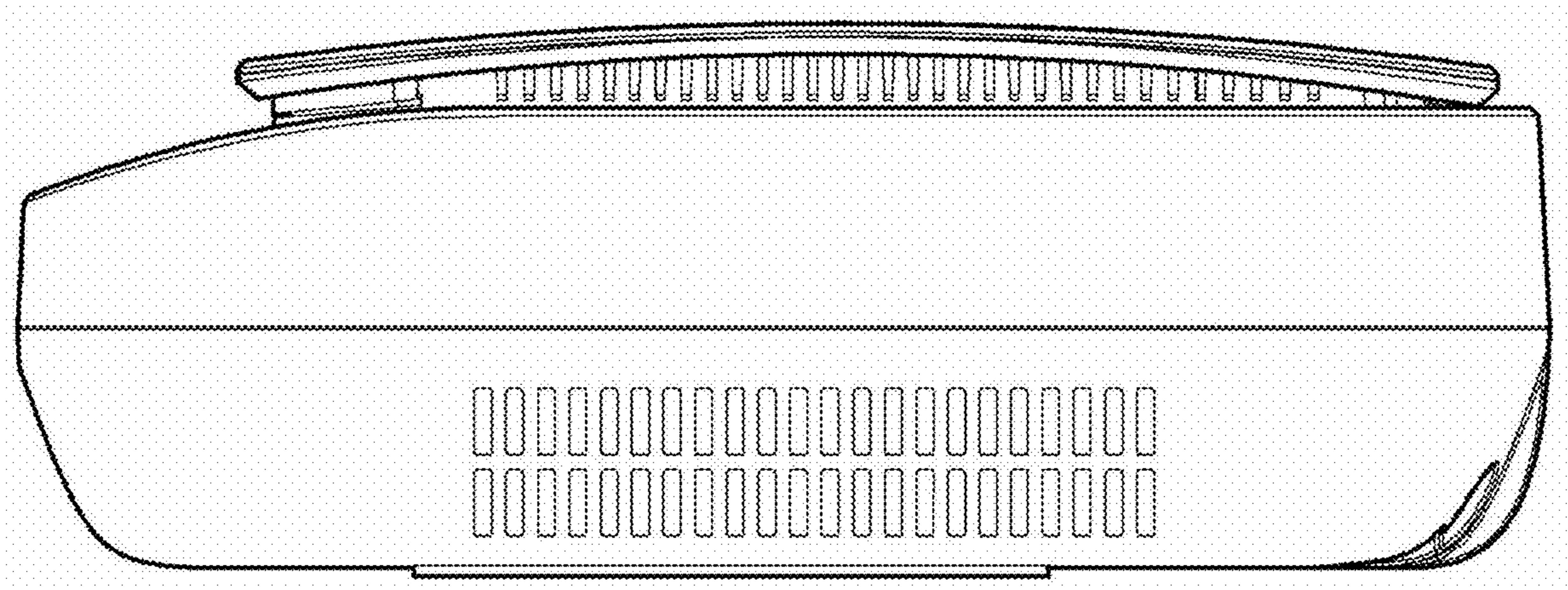

1.5

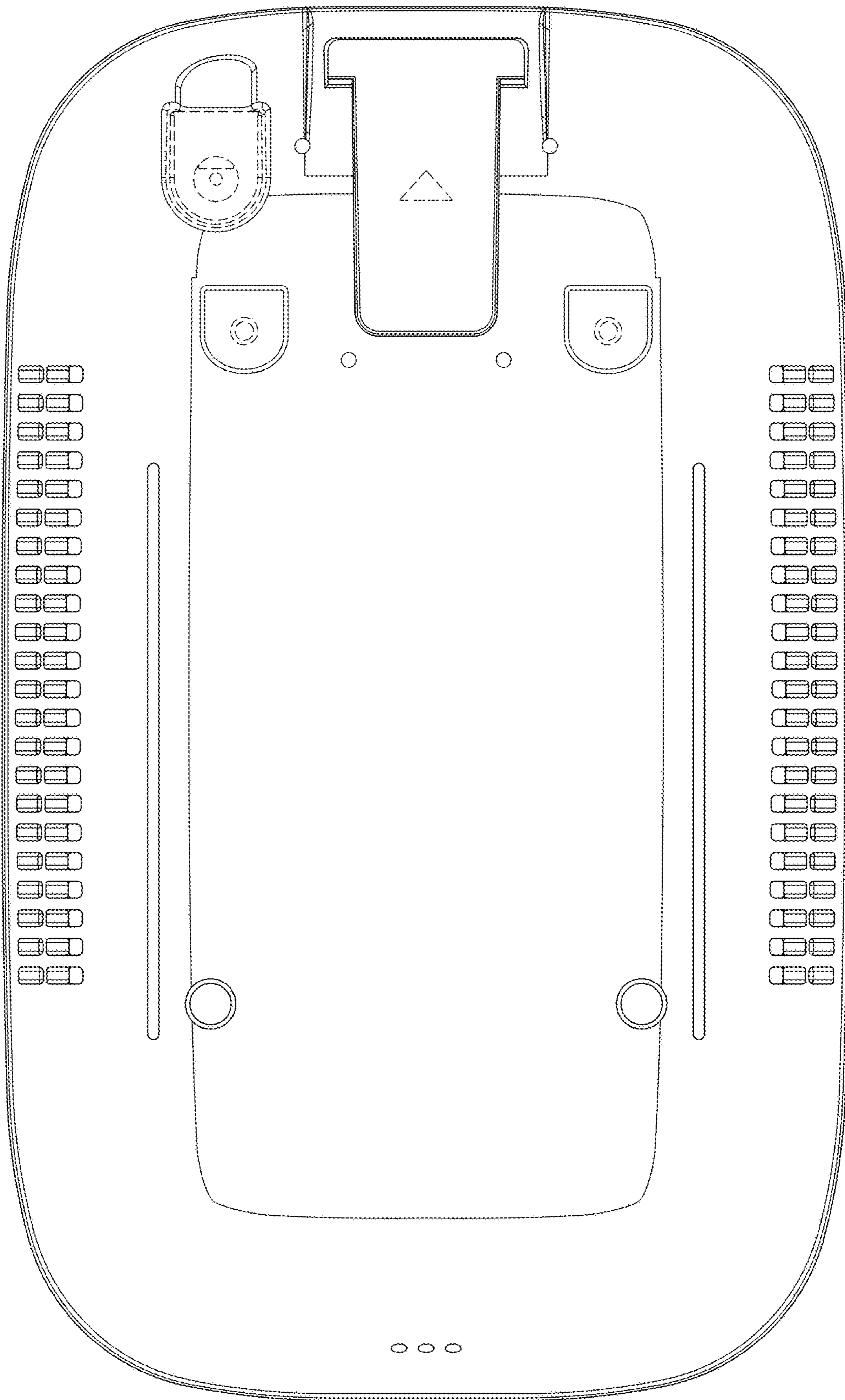

1.6

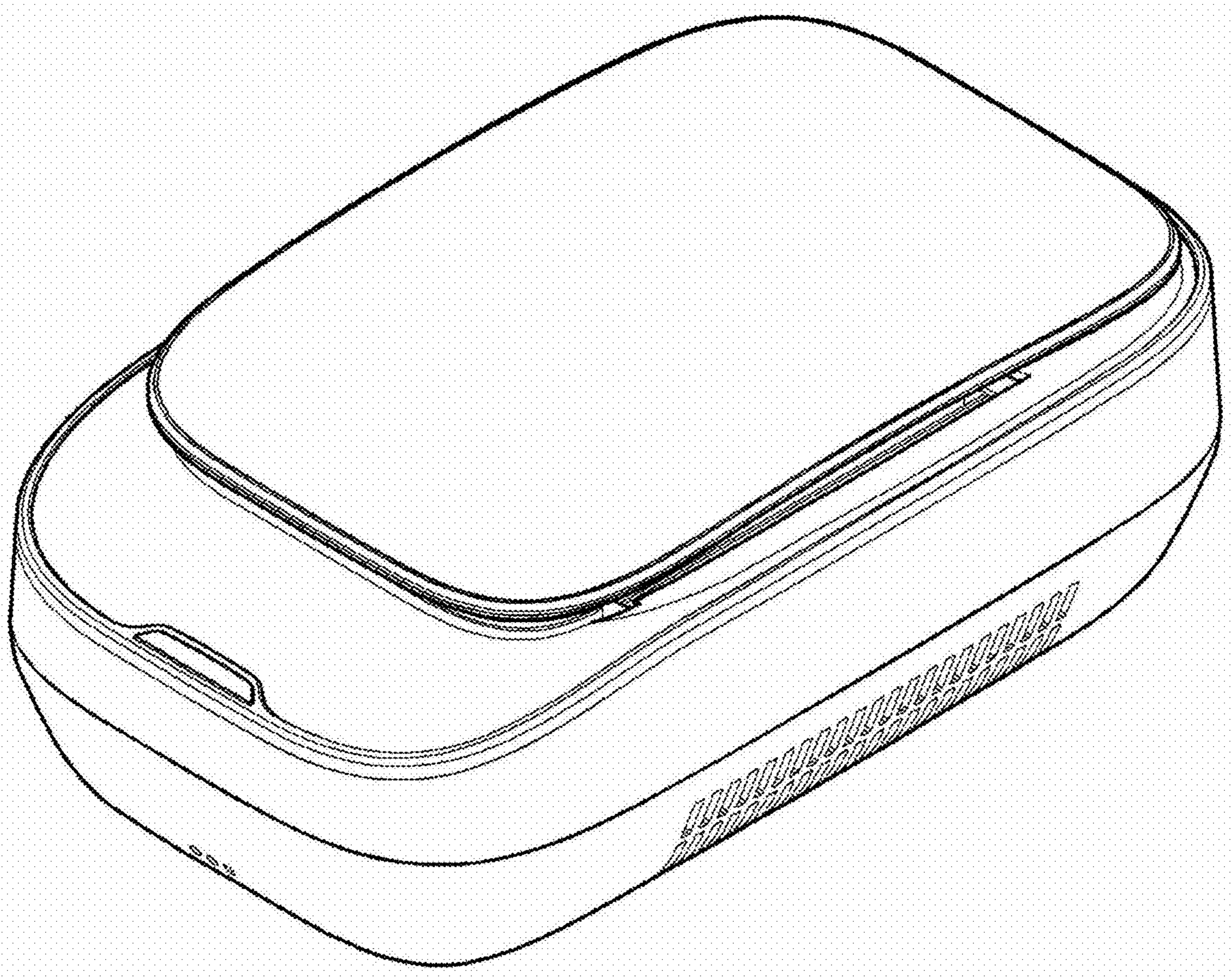

1.7

