



US00D804002S

(12) **United States Design Patent**  
**Huang**

(10) **Patent No.:** **US D804,002 S**

(45) **Date of Patent:** **\*\* Nov. 28, 2017**

(54) **AIR PURIFIER**

(71) Applicant: **HUNG HSING ELECTRIC CO., LTD.**, Tainan (TW)

(72) Inventor: **Ping Huang**, Tainan (TW)

(73) Assignee: **Hung Hsing Electric Co., Ltd.**, Tainan (TW)

(\*\*) Term: **15 Years**

(21) Appl. No.: **29/564,492**

(22) Filed: **May 13, 2016**

(51) **LOC (10) Cl.** ..... **23-04**

(52) **U.S. Cl.**  
USPC ..... **D23/364**

(58) **Field of Classification Search**  
USPC ..... D23/332–336, 342, 351, 352, 355–366,  
D23/369, 370; D14/168, 170–172, 188,  
D14/216, 496  
CPC .... A62B 21/00; B01D 46/0002; B01D 46/10;  
F02M 35/04; F24F 13/20  
See application file for complete search history.

(56) **References Cited**

**U.S. PATENT DOCUMENTS**

D325,628 S \* 4/1992 Cho ..... D23/370  
D506,000 S \* 6/2005 Christianson ..... D23/364

D523,128 S \* 6/2006 Zhu ..... D23/364  
D574,072 S \* 7/2008 Carlson ..... D23/364  
D580,028 S \* 11/2008 Catrino ..... D23/332  
D686,186 S \* 7/2013 Kaneko ..... D14/168  
D699,336 S \* 2/2014 Girard ..... D23/370  
D744,541 S \* 12/2015 Langhammer ..... D14/203.1  
D764,649 S \* 8/2016 Ko ..... D23/364

\* cited by examiner

*Primary Examiner* — Robert M Spear

*Assistant Examiner* — John Voytek

(74) *Attorney, Agent, or Firm* — Rosenberg, Klein & Lee

(57) **CLAIM**

The ornamental design for an air purifier, as shown and described.

**DESCRIPTION**

FIG. 1 is a perspective view of an air purifier showing my new design;  
FIG. 2 is a front elevational view thereof;  
FIG. 3 is a rear elevational view thereof;  
FIG. 4 is a left side elevational view thereof;  
FIG. 5 is a right side elevational view thereof;  
FIG. 6 is a top plan view thereof; and,  
FIG. 7 is a bottom plan view thereof.  
In the drawings, the broken lines showing of the air purifier are for the purposes of illustrating portions of the “article” and form no part of the claimed design.

**1 Claim, 7 Drawing Sheets**

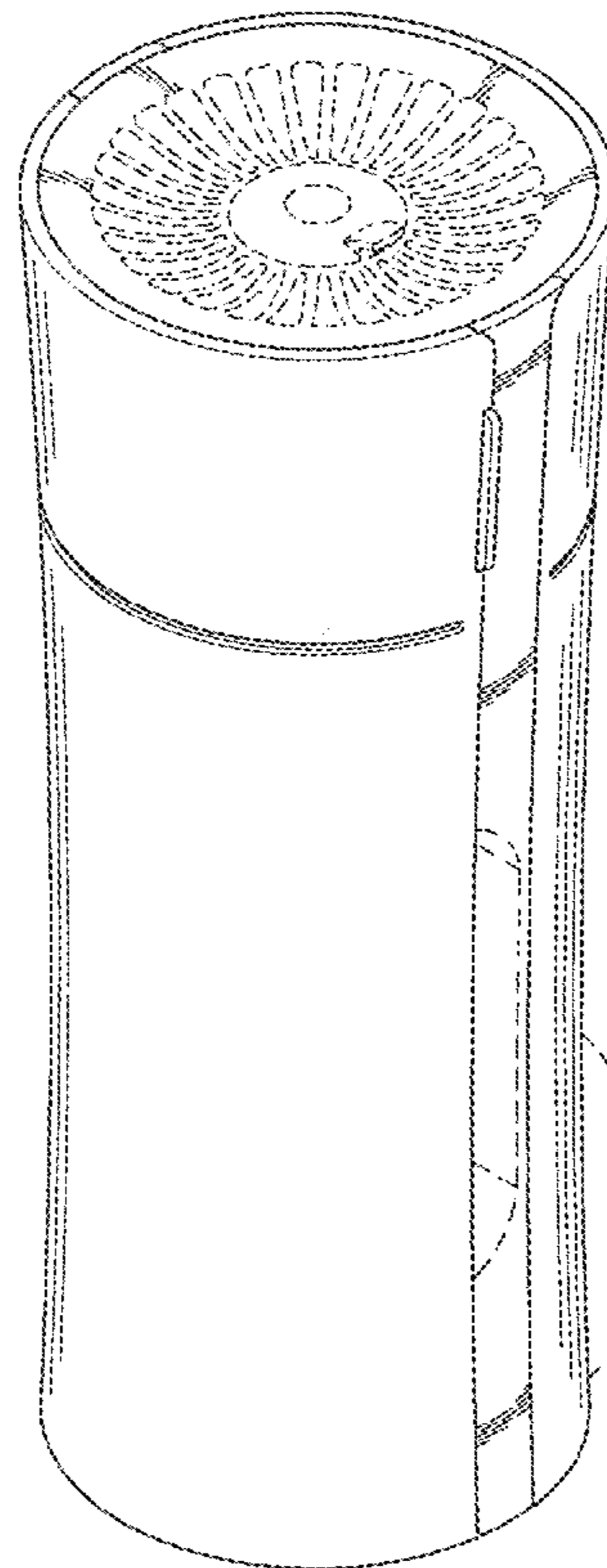

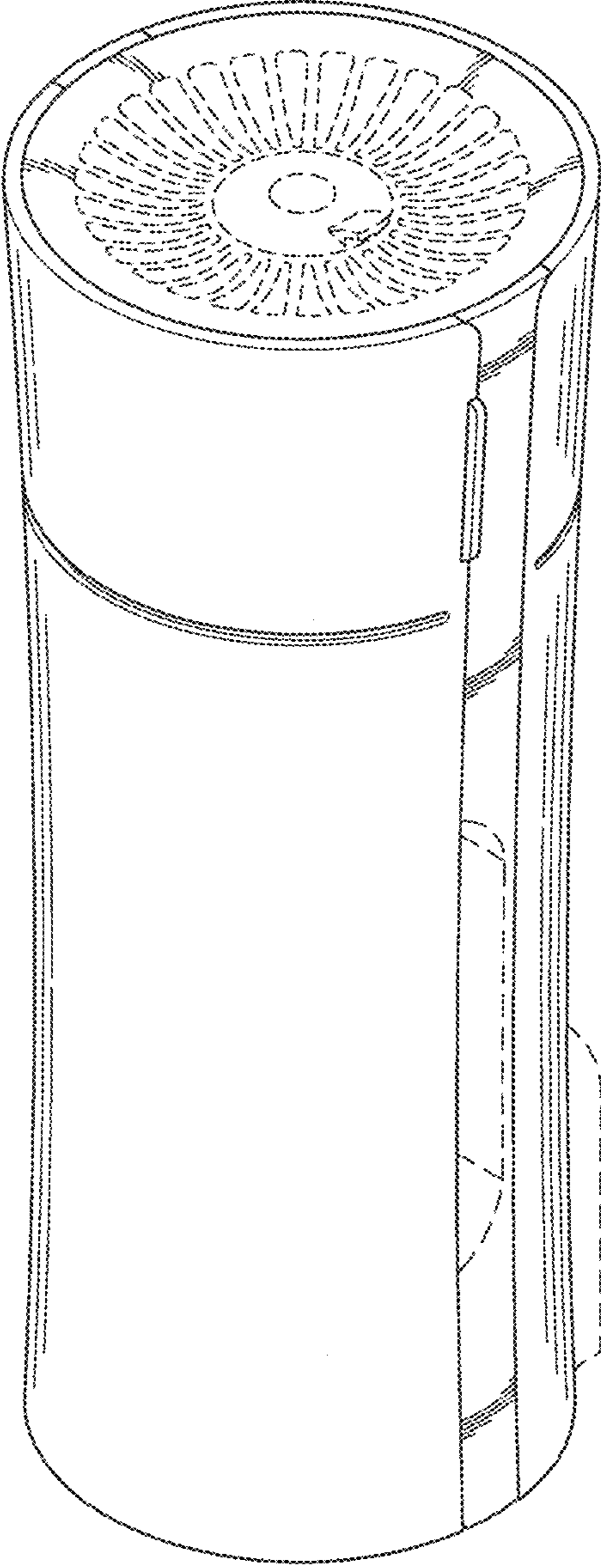

FIG. 1

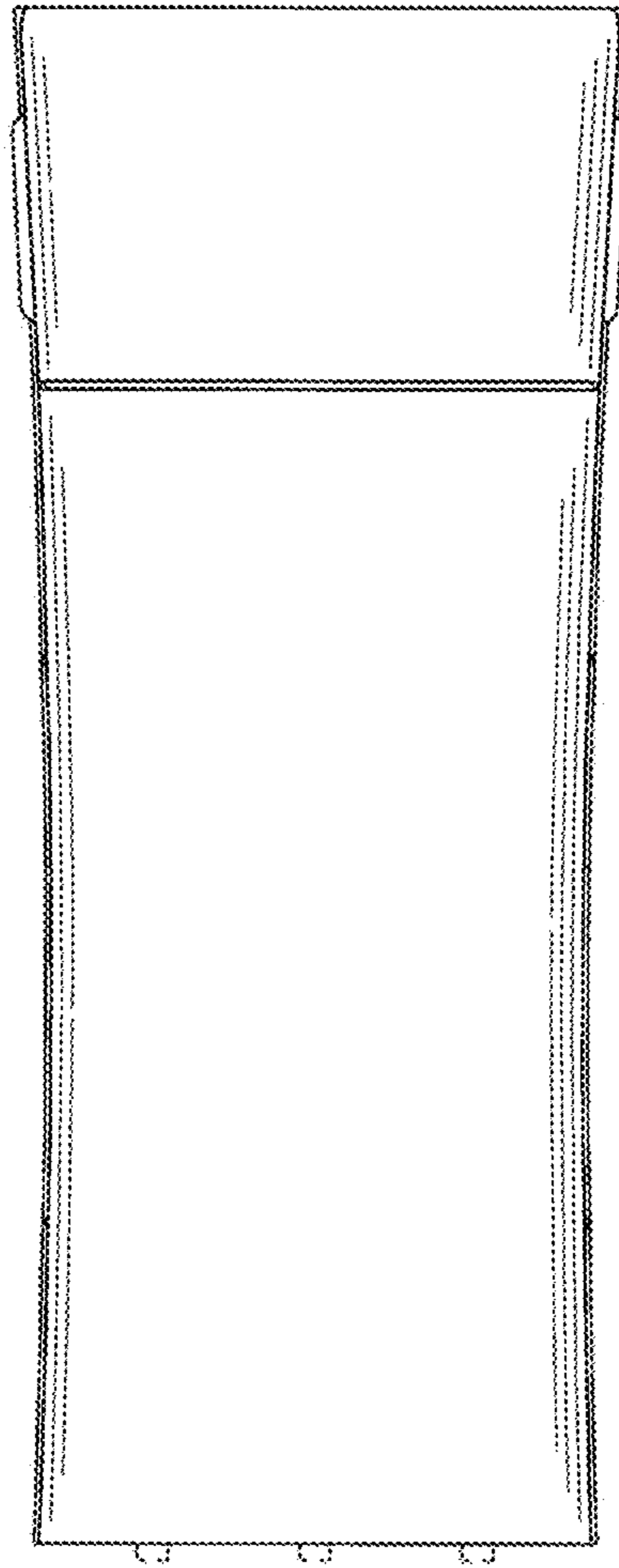

FIG. 2

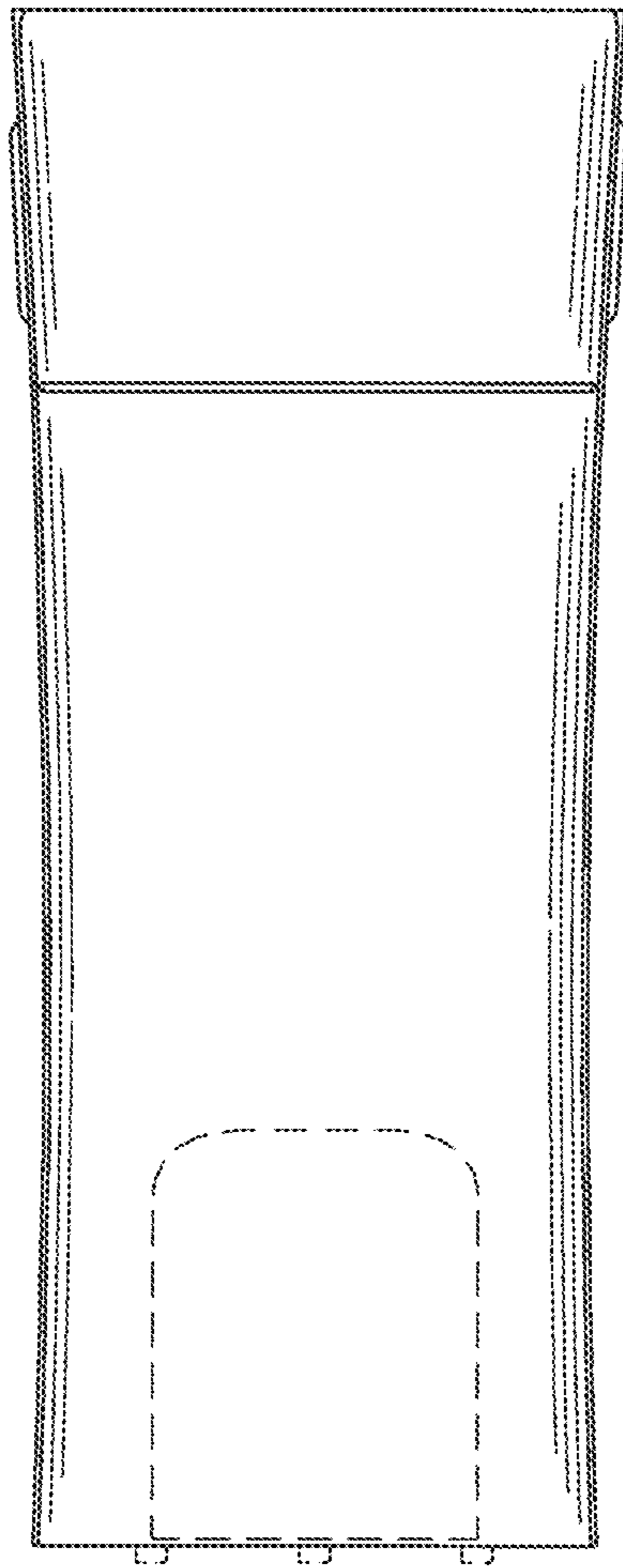

FIG. 3

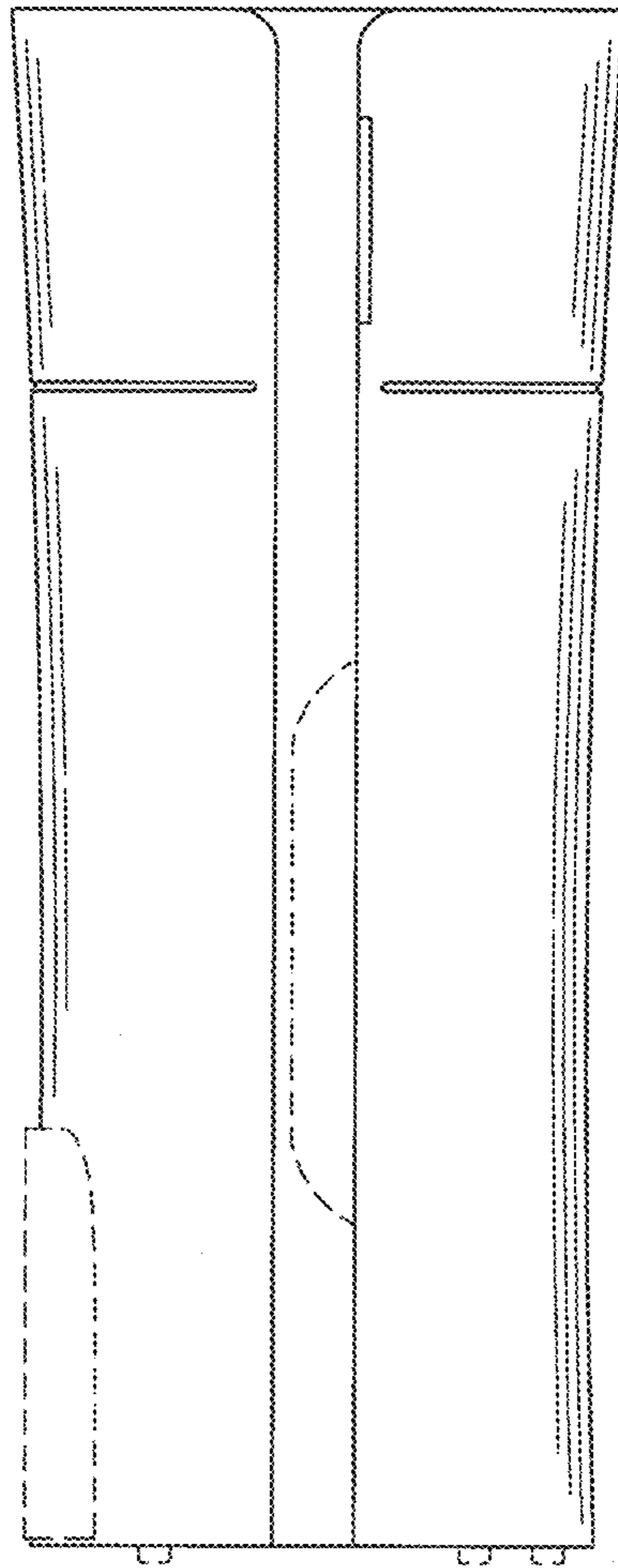

FIG. 4

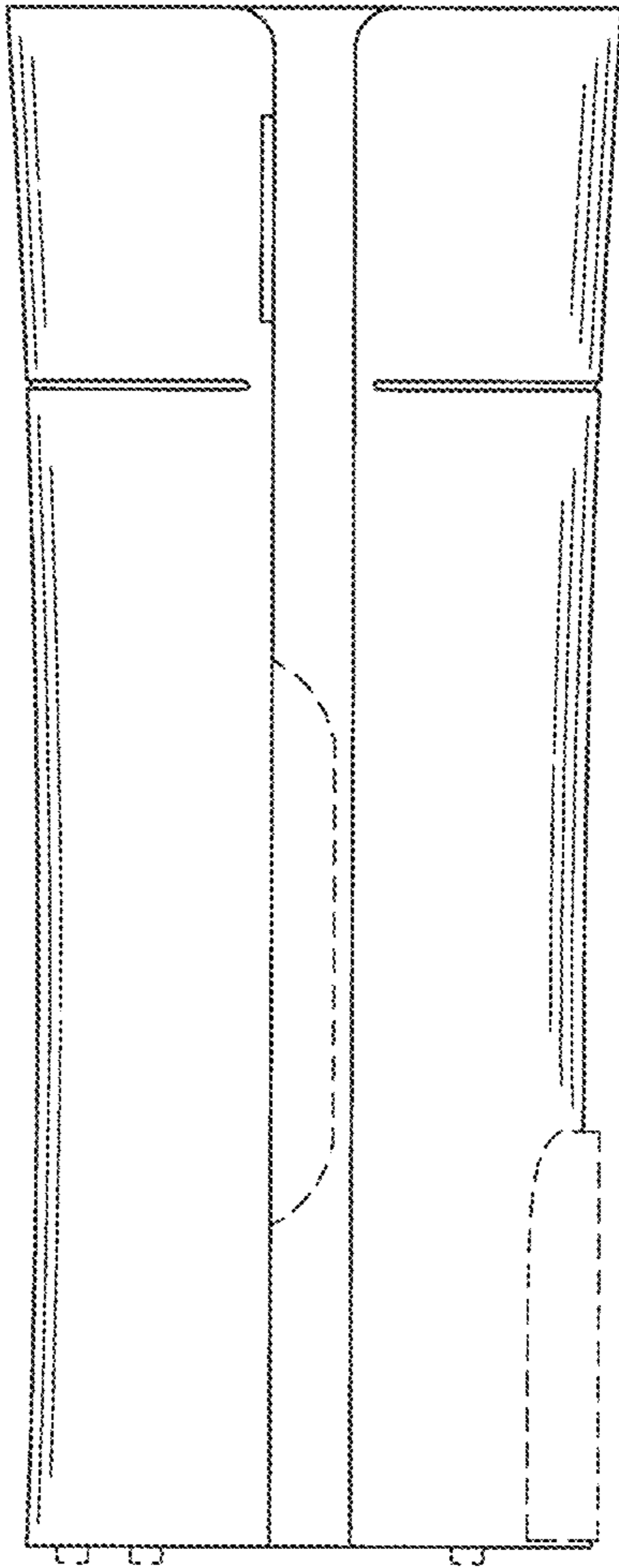

FIG. 5

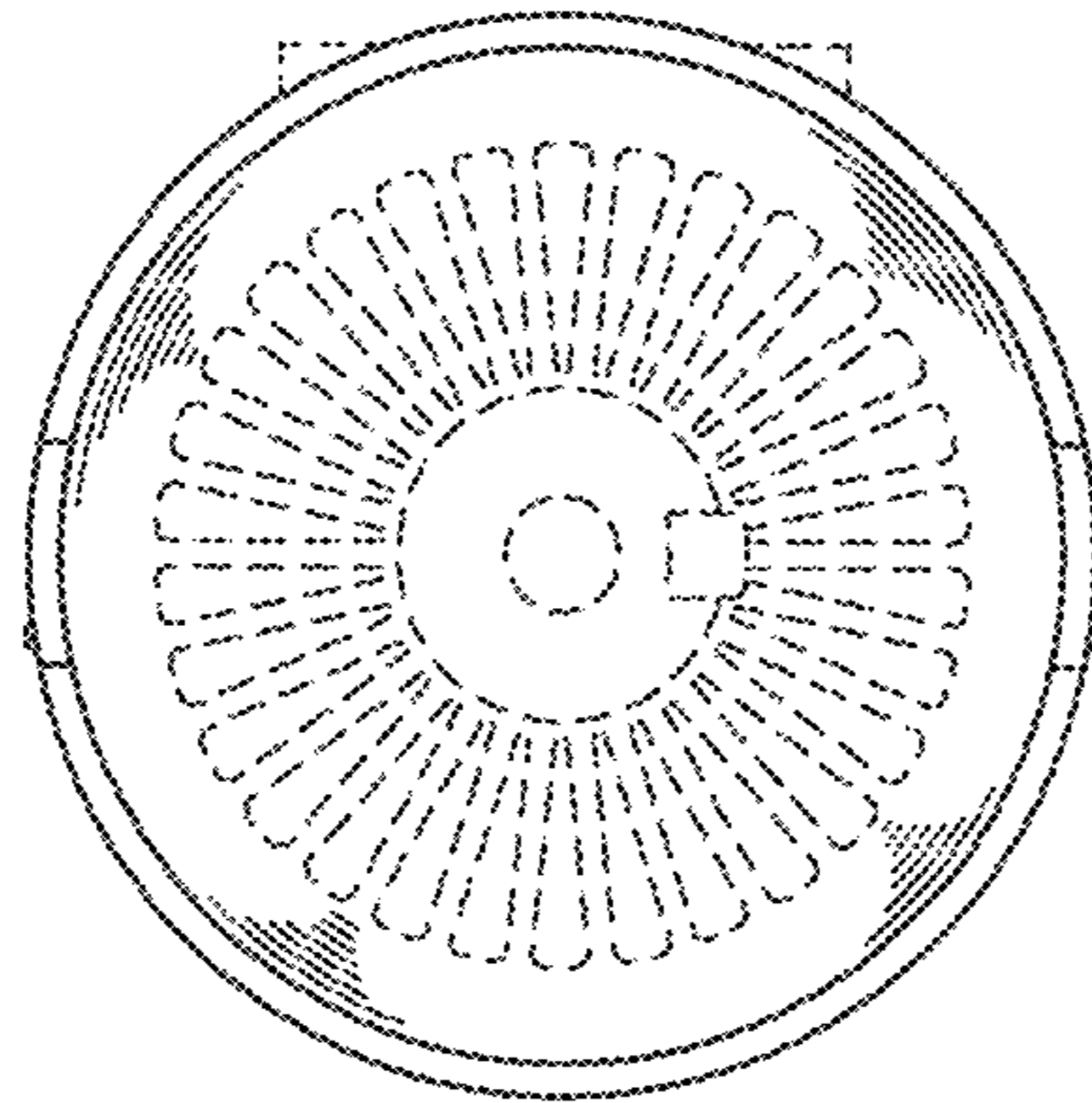

FIG. 6

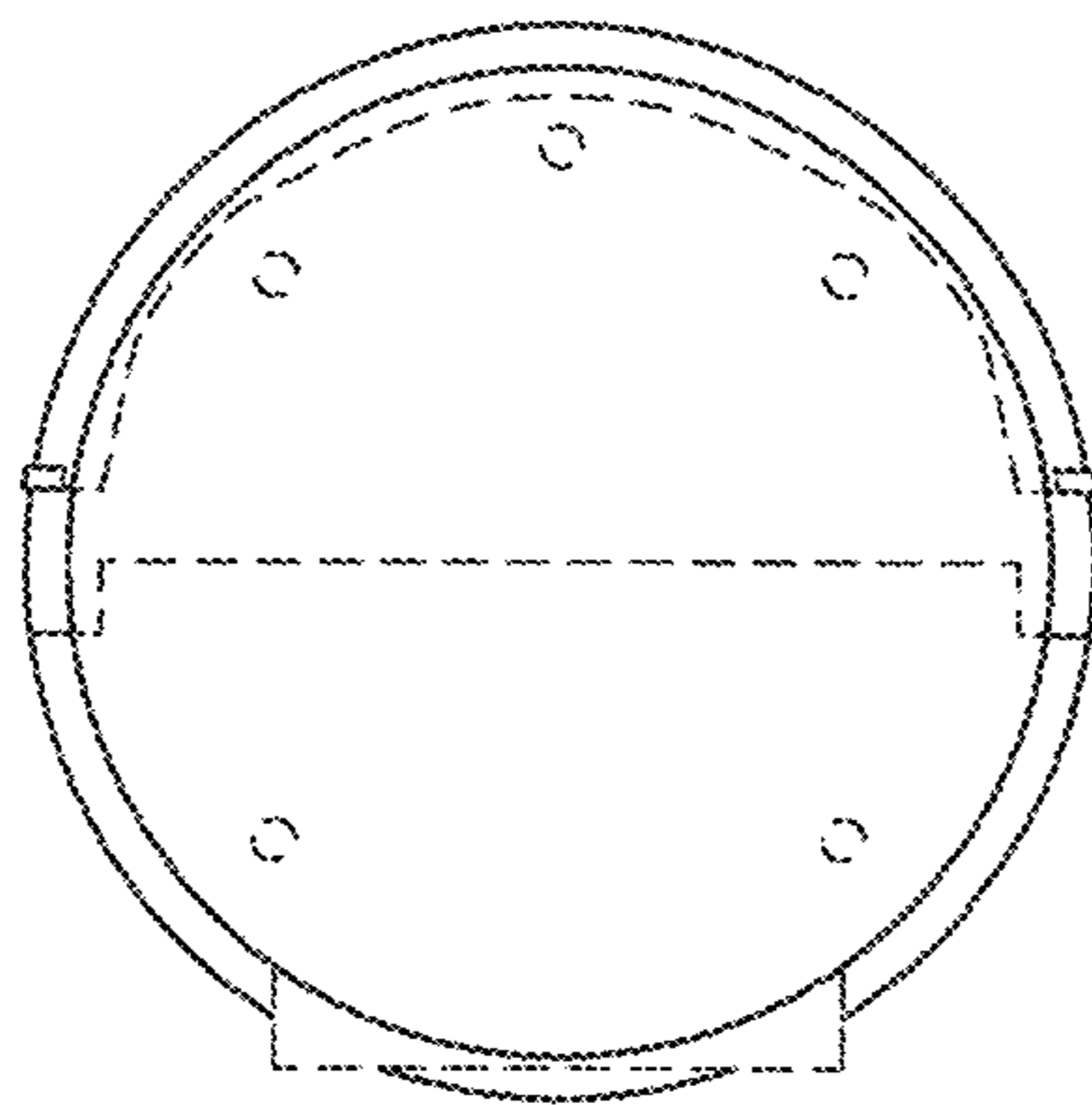

FIG. 7