



US00D803957S

(12) **United States Design Patent** (10) **Patent No.:** **US D803,957 S**
Stocking, Sr. et al. (45) **Date of Patent:** **** Nov. 28, 2017**

(54) **PUSH UP VEST**
(71) Applicants: **Travis Stocking, Sr.**, Spring Valley, CA (US); **Travis Stocking, Jr.**, Spring Valley, CA (US)

D274,194 S * 6/1984 Ruty D21/683
5,042,796 A 8/1991 Jibril
D340,794 S * 11/1993 Winston D21/683
(Continued)

(72) Inventors: **Travis Stocking, Sr.**, Spring Valley, CA (US); **Travis Stocking, Jr.**, Spring Valley, CA (US)

OTHER PUBLICATIONS

Star G Multi-Purpose Vest by Stargfitness dated no date given. Found online [Nov. 16, 2016] <http://www.stargfitness.com/product-page/6c14da30-7958-46ca-66d3-ae72710f320a>.*

(**) Term: **15 Years**

Primary Examiner — Robert M Spear

(21) Appl. No.: **29/546,026**

Assistant Examiner — Ryan Harvey

(22) Filed: **Nov. 18, 2015**

(74) *Attorney, Agent, or Firm* — Lewis Kohn & Walker LLP; David M. Kohn; Kari Moyer-Henry

(51) **LOC (10) Cl.** **21-02**

(52) **U.S. Cl.**
USPC **D21/683**

(57) **CLAIM**

(58) **Field of Classification Search**

USPC D2/502, 900, 627; D21/692, 662, 684; D29/100, 101.5; D30/153; D24/190; D3/218; 602/27, 16, 65, 4, 23; 482/124, 482/139, 123, 126, 106, 121, 904, 91, 482/148, 907, 92, 125, 129, 49, 55, 93; 405/186, 185; 224/664, 934, 577, 236, 224/576, 586, 683, 666, 240, 660, 677, 224/901, 901.4, 901.8, 911, 681, 662, 224/910, 930; 2/322, 338, 920, 237, 312, 2/1, 311, 84, 87, 93, 660, 680, 94, 308, 2/321, 221; 128/95.1, 875, 882, 876; 36/140, 50.1, 89
CPC A63B 21/0552; A63B 21/0442; A63B 21/0557; A63B 2208/0204; A63B 21/0555; A63B 21/0004; A63B 21/00061; A63B 21/00069; A63B 21/4025; A63B 21/4035; Y10S 482/907; A61H 1/0244; A61H 1/0266

The ornamental design for a push up vest, as shown and described.

See application file for complete search history.

DESCRIPTION

FIG. 1 is a front view of the push up vest embodied in the present invention;
FIG. 2 is a right side view of the push up vest embodied in the present invention;
FIG. 3 is a back view of the push up vest embodied in the present invention;
FIG. 4 is a left side view of the push up vest embodied in the present invention;
FIG. 5 is a top view of the push up vest embodied in the present invention;
FIG. 6 is a right side view of an alternative embodiment of the push up vest embodied in the present invention; and,
FIG. 7 is a perspective view of the push up vest embodiment in the present invention.
The dash-dash-dash type broken line shown in FIG. 2 to FIG. 7 is included for the purpose of illustrating environmental context and forms no part of the claimed design.

(56) **References Cited**

U.S. PATENT DOCUMENTS

D226,538 S * 3/1973 Freider D21/805
D232,317 S * 8/1974 Rutland D21/805

1 Claim, 4 Drawing Sheets

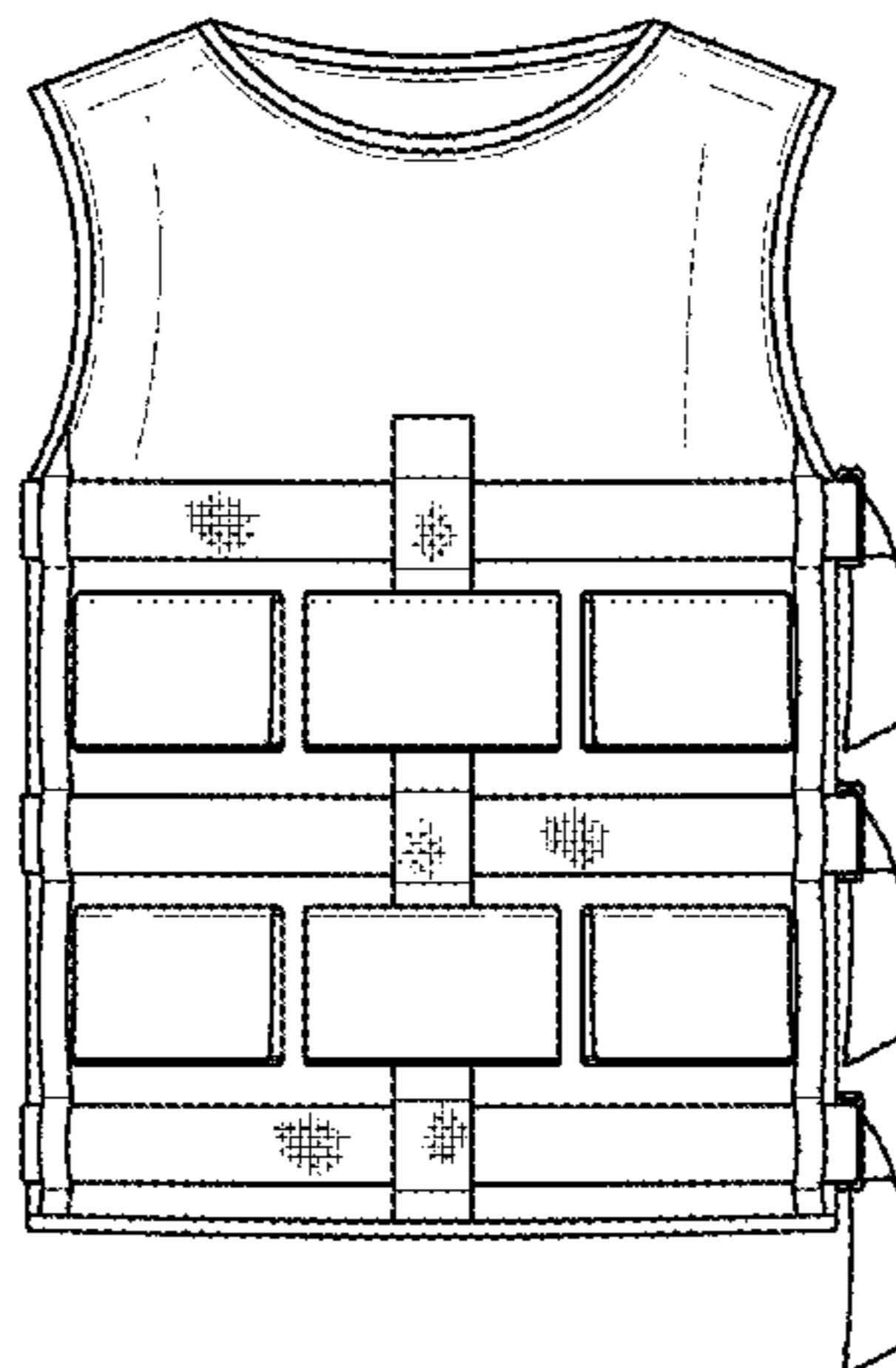

(56)

References Cited

U.S. PATENT DOCUMENTS

5,514,019 A * 5/1996 Smith A41D 13/0007
 2/311
 D375,581 S * 11/1996 Dyer D29/101.1
 D390,338 S * 2/1998 Plasco D2/828
 D409,697 S * 5/1999 Ott D21/683
 D422,666 S * 4/2000 Wagner D21/805
 D423,761 S * 5/2000 Ng D2/829
 D475,837 S * 6/2003 Neider D2/839
 D554,225 S * 10/2007 Peterson D21/805
 D594,633 S * 6/2009 Floyd D2/731
 D602,678 S * 10/2009 Foley D2/829
 D611,681 S * 3/2010 Pettingill D2/839
 7,707,652 B2 * 5/2010 Senegal A63B 21/0552
 2/102
 7,854,694 B1 * 12/2010 Frunzi A63B 21/0552
 482/121
 D641,960 S * 7/2011 Goff D2/829
 8,262,545 B1 * 9/2012 Beber A63B 21/065
 2/102
 D686,391 S * 7/2013 Beber D2/829
 D706,888 S * 6/2014 Gideon D21/698
 D729,499 S * 5/2015 Christenson D2/829
 D732,118 S * 6/2015 Hamilton D21/662
 2003/0167552 A1 9/2003 Murray
 2007/0219074 A1 * 9/2007 Pride A63B 21/023
 482/124
 2008/0301863 A1 * 12/2008 Goff A41D 13/0012
 2/467
 2010/0323824 A1 * 12/2010 Gamboa A63B 69/00
 473/438
 2012/0202658 A1 * 8/2012 Menefee, Sr. ... A63B 21/00061
 482/124

* cited by examiner

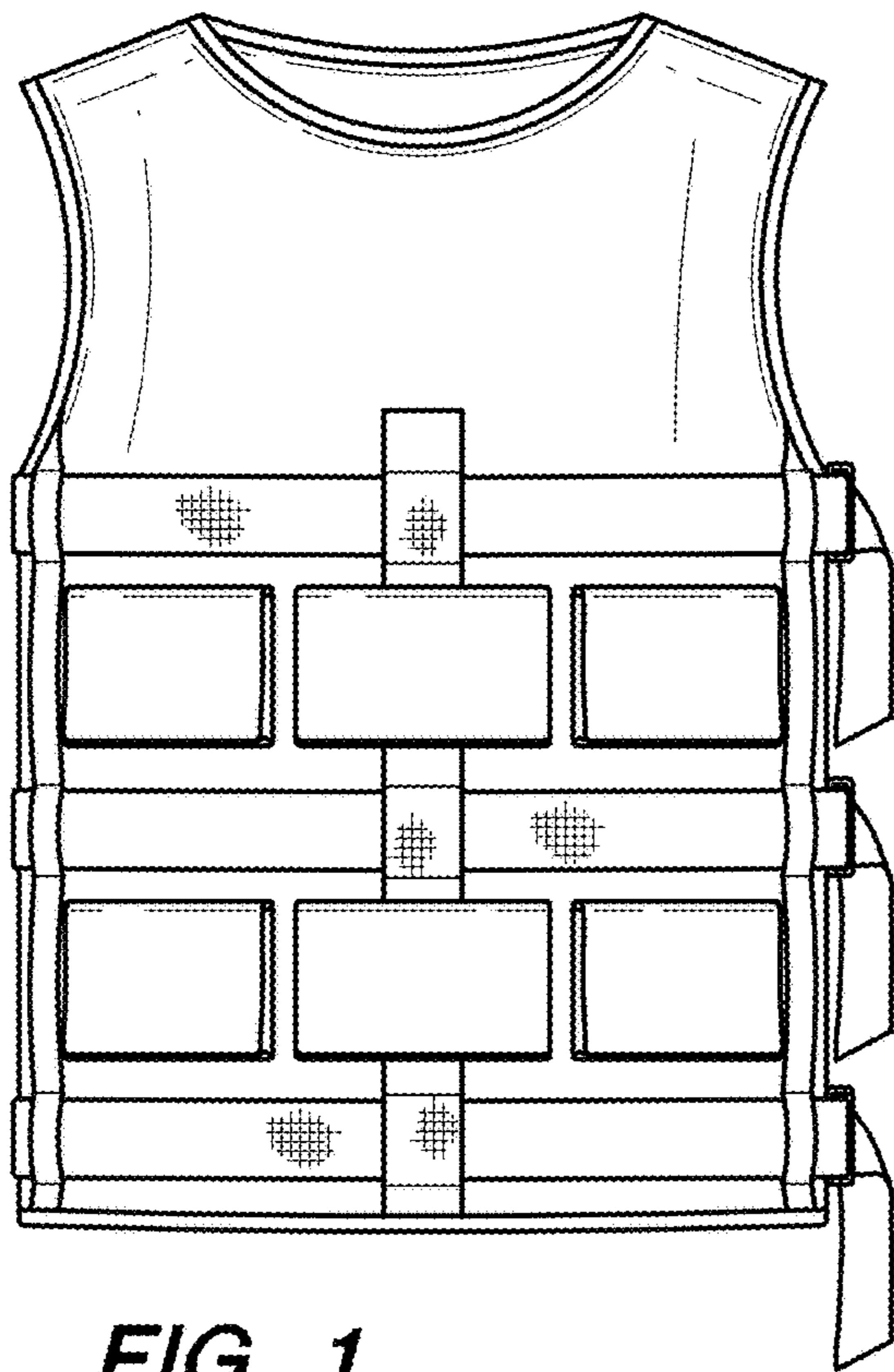

FIG. 1

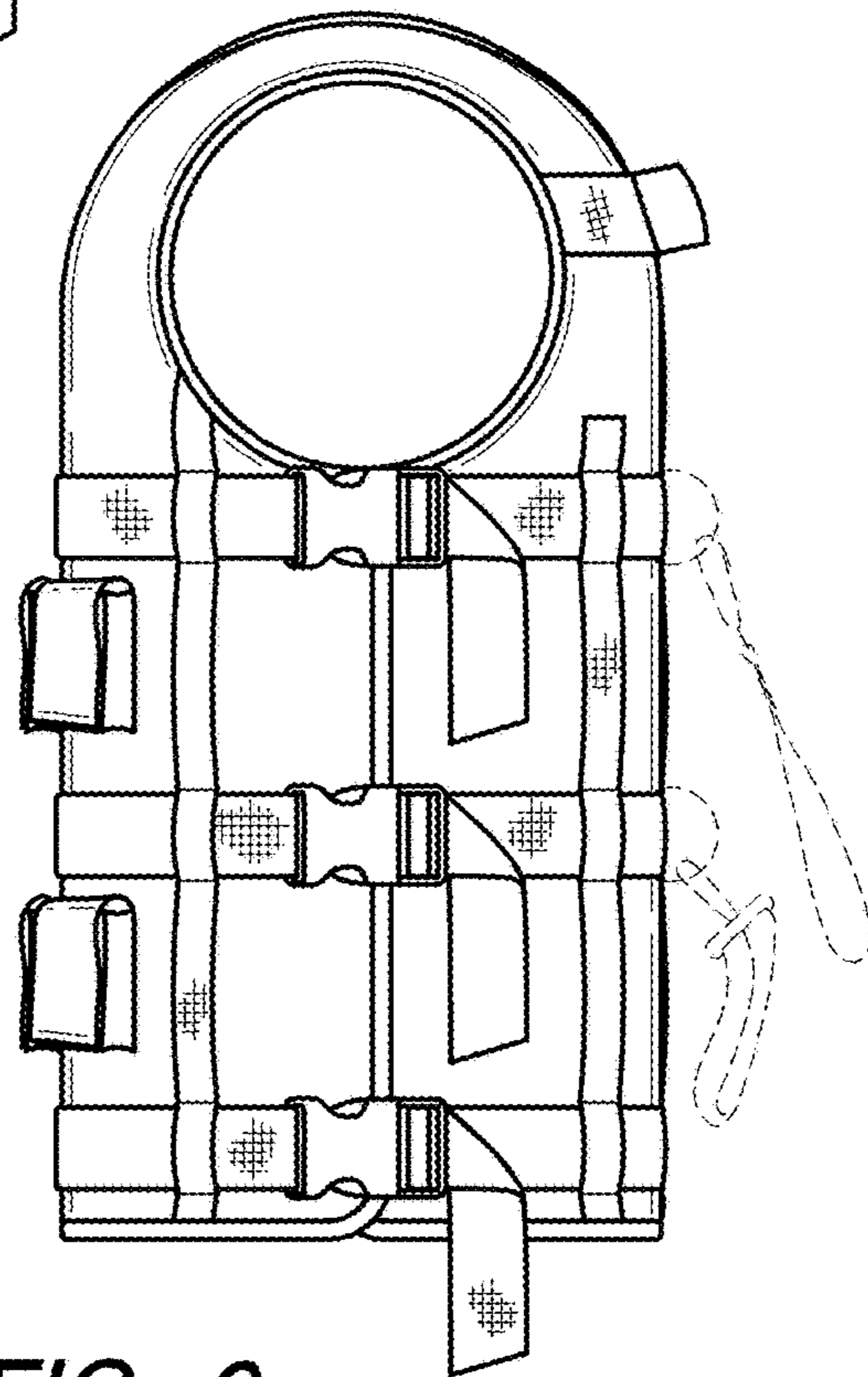

FIG. 2

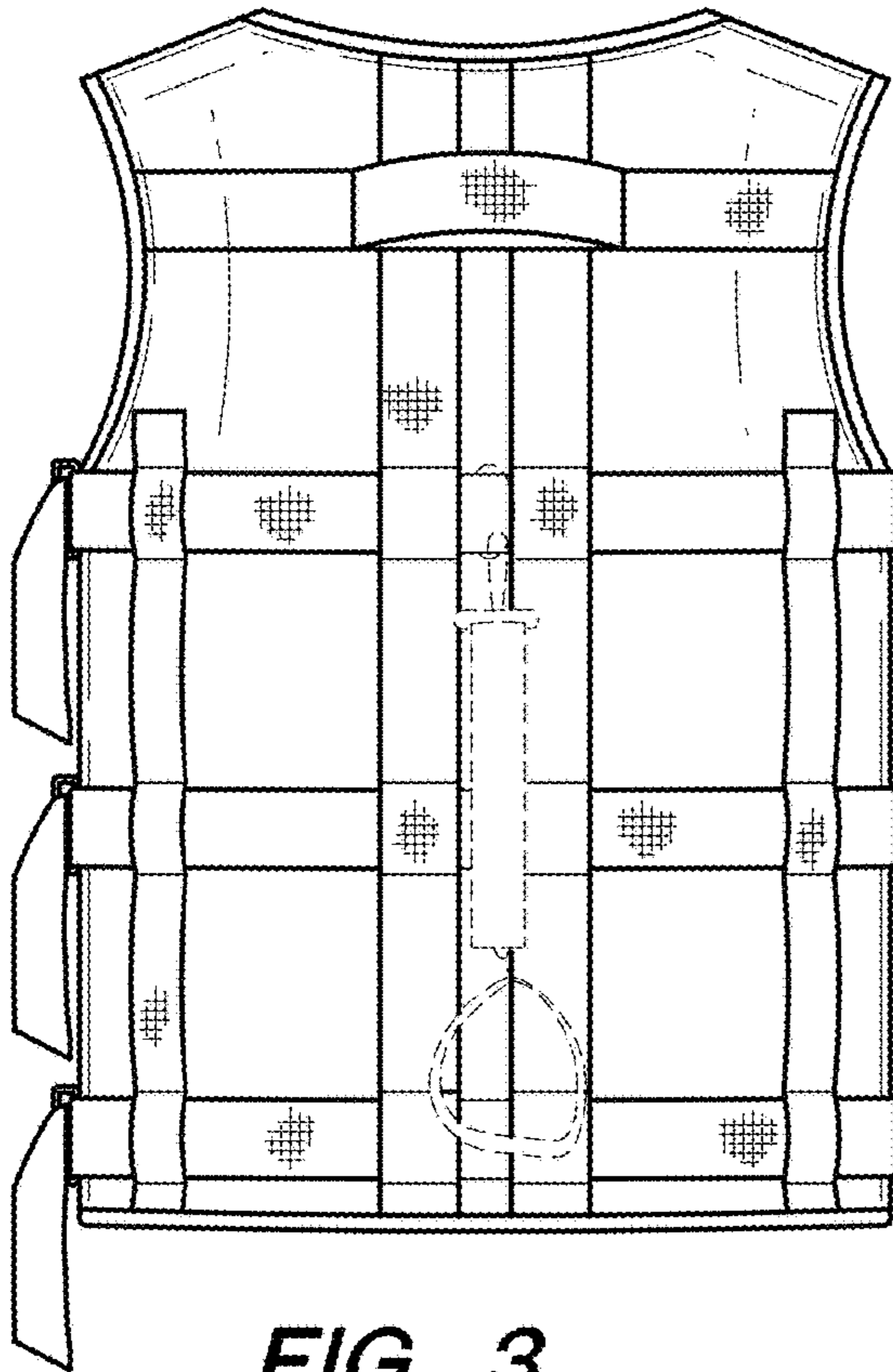

FIG. 3

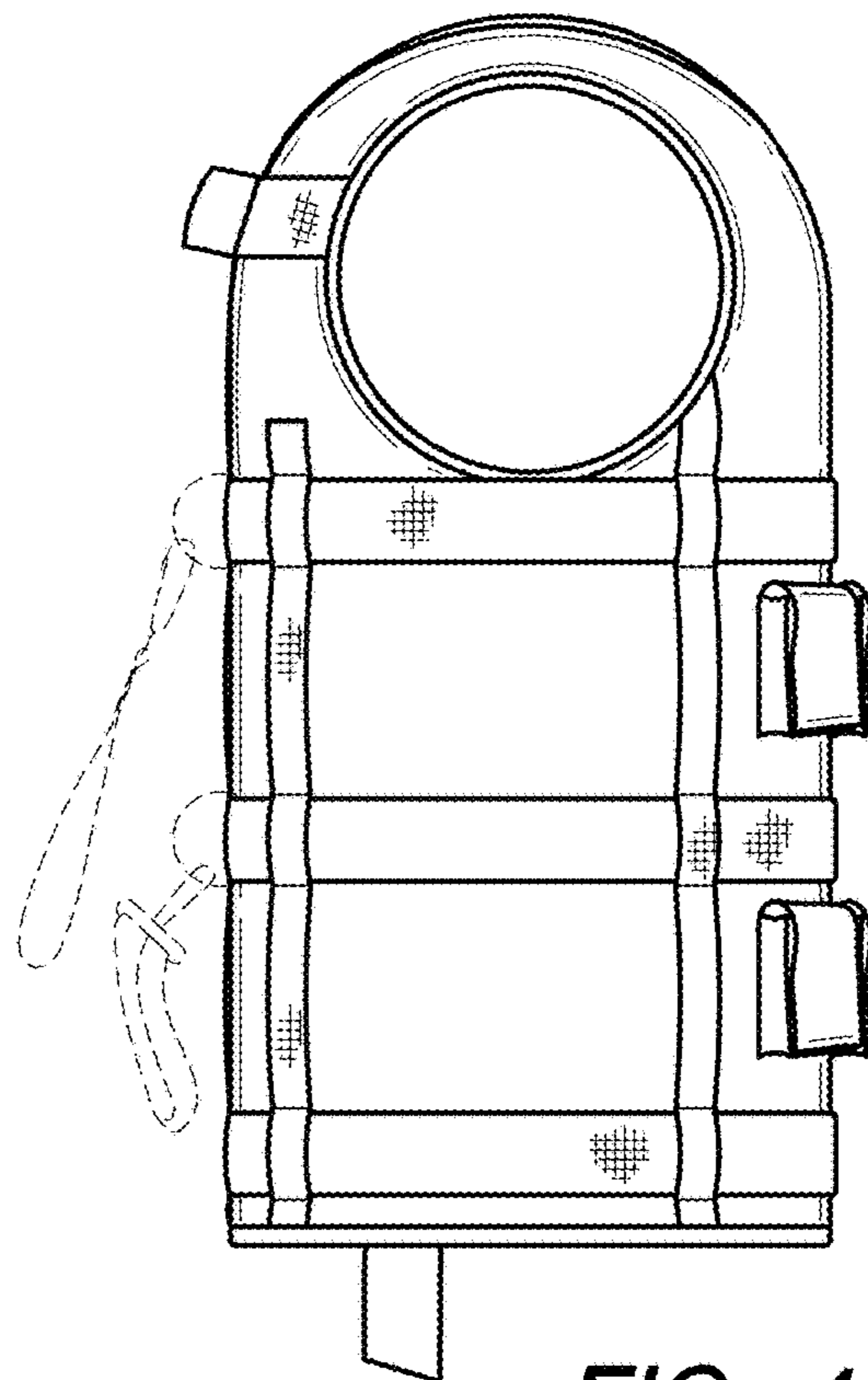

FIG. 4

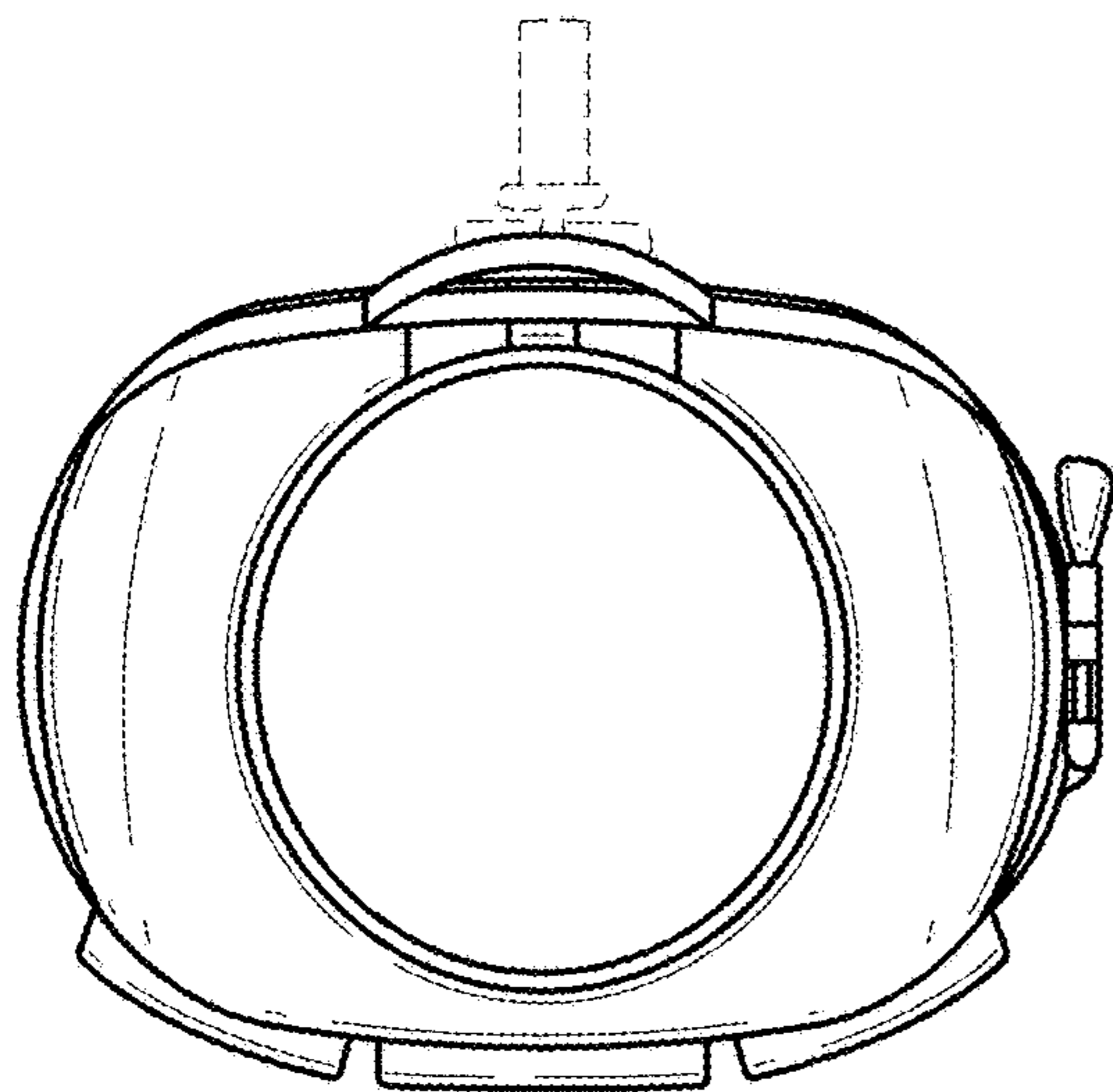

FIG. 5

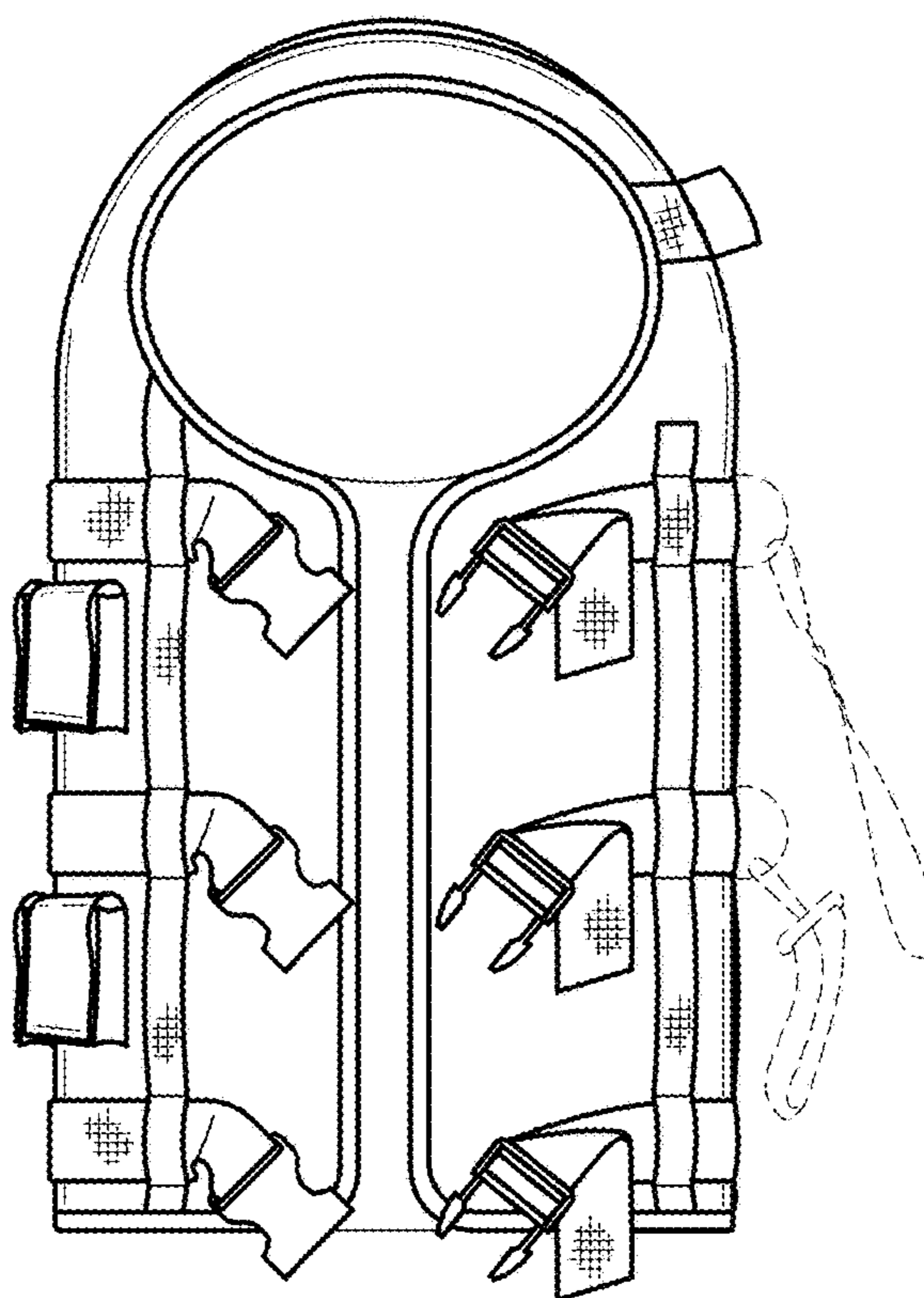

FIG. 6

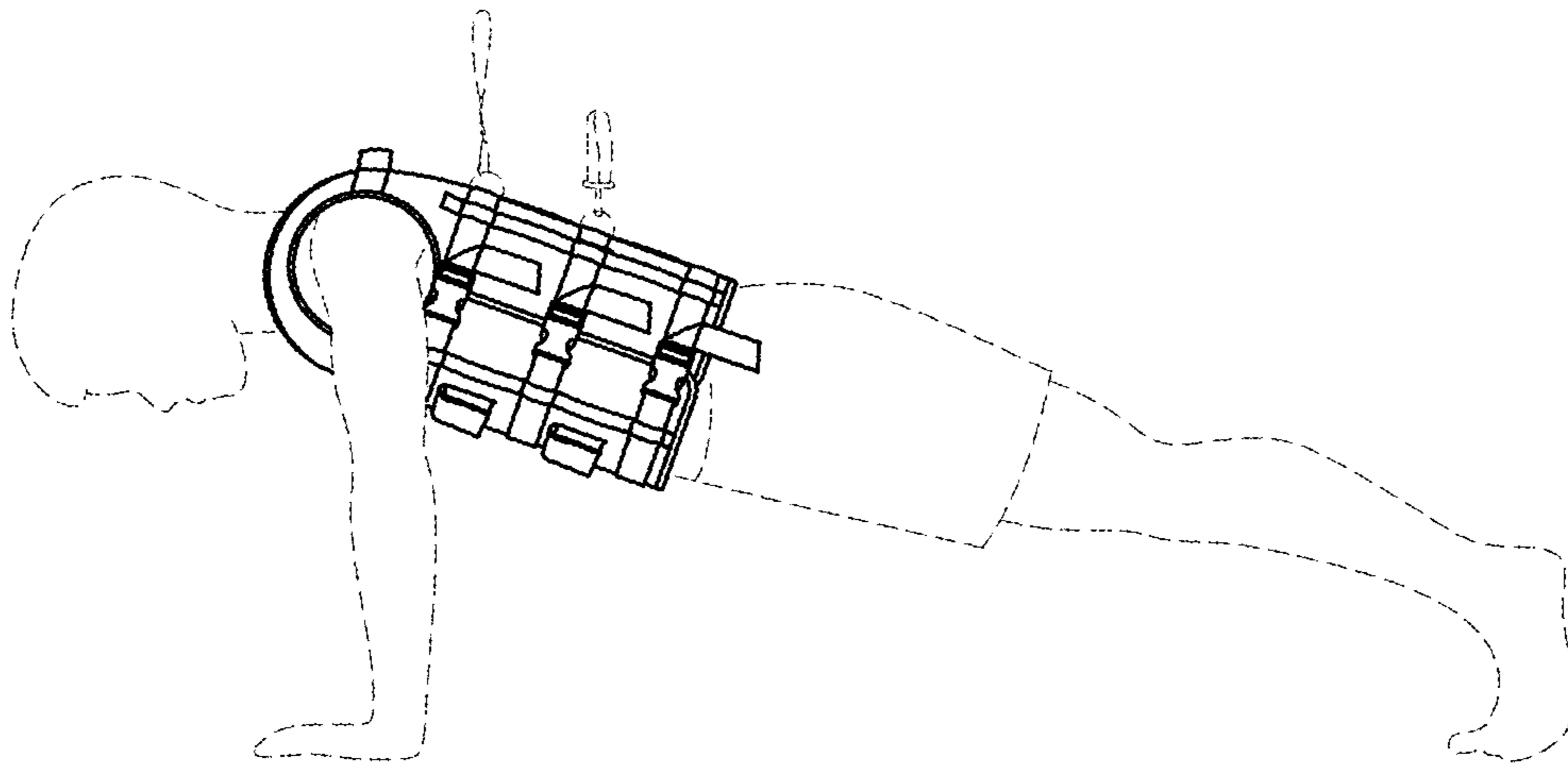

FIG. 7